

**Strut materiaal**

thermisch verzinkt

*Strut material*

*hot dip galvanized*



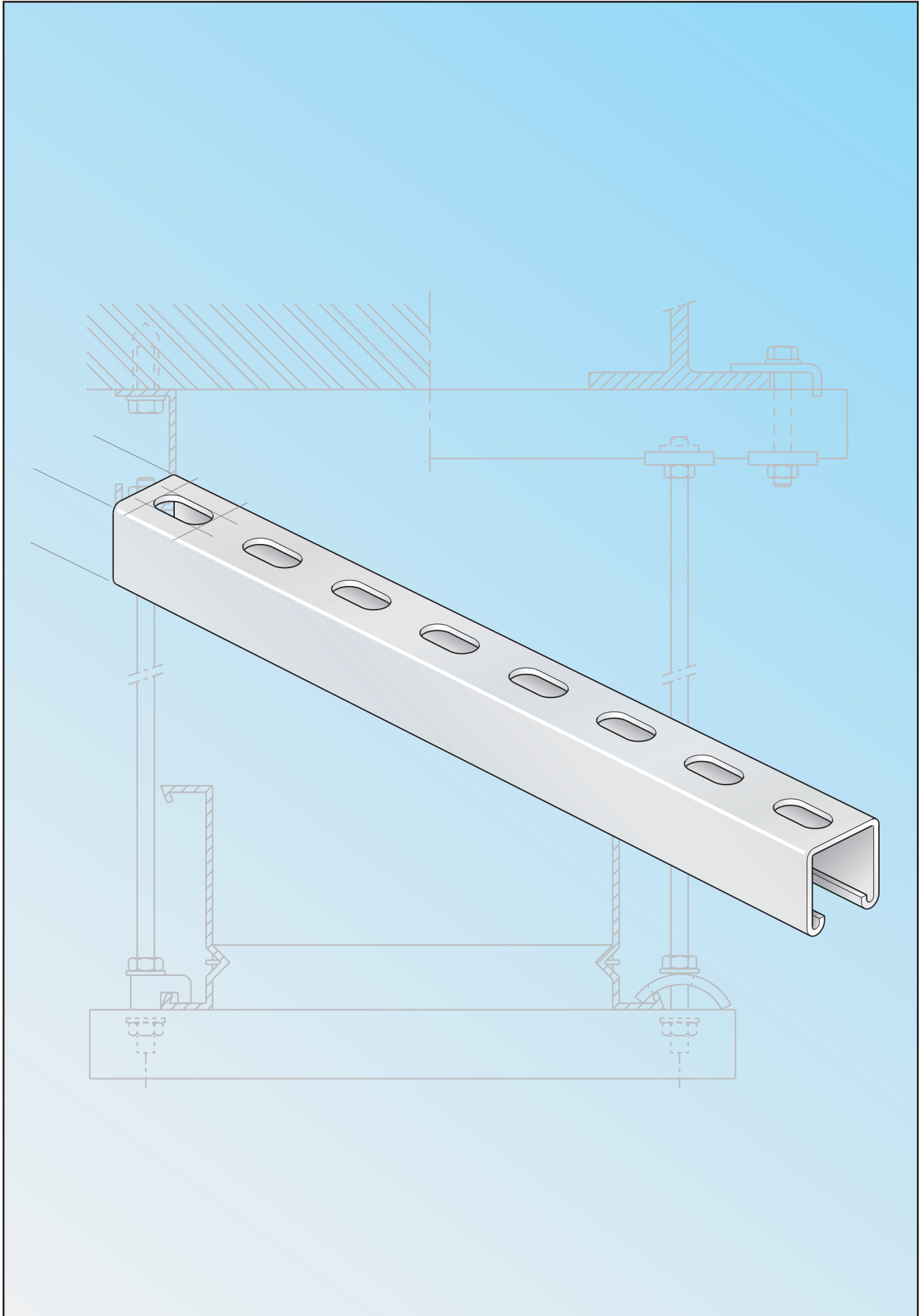

## Montagerail = B21 Hanger channel = B21

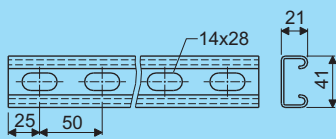

L	Artikel nr. Product no.	Gewicht Weight
3000	98026.203	5,28
6000	98027.203	10,56

## Montagerail = B41 Hanger channel = B41

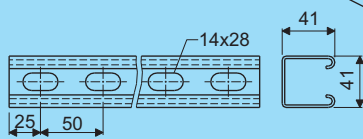

L	Artikel nr. Product no.	Gewicht Weight
3000	98056.203	8,19
6000	98057.203	16,38

## Afdichtstop Seal cap

Type	Artikel nr. Product no.	Gewicht Weight
B=21	99961.207	0,01
B=41	99963.207	0,01

PVC  
zwart / black

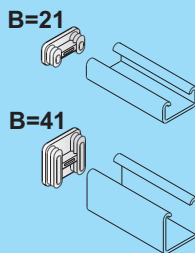

## Moerplaat Nut plate



Type	Artikel nr. Product no.	Gewicht Weight
M6	98086.203	0,03
M8	98088.203	0,04
M10	98090.203	0,04

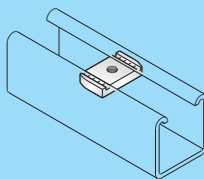

## Montagestrip / Railplaat Mounting strip / Rail plate

Type	Artikel nr. Product no.	Gewicht Weight
MP-1	98078.203	0,07

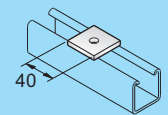

MP-1

## Montagestrip - 2 gaten Mounting strip - 2 holes

Type	Artikel nr. Product no.	Gewicht Weight
MP-2	98101.203	0,16

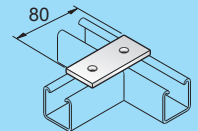

MP-2

## Montagestrip - 3 gaten Mounting strip - 3 holes

Type	Artikel nr. Product no.	Gewicht Weight
MP-3	98103.203	0,24

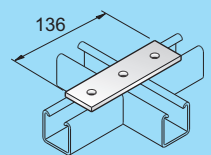

MP-3

## Montagestrip - 4 gaten Mounting strip - 4 holes

Type	Artikel nr. Product no.	Gewicht Weight
MP-4	98105.203	0,32

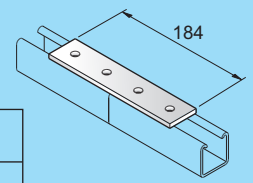

MP-4

## T-stuk - 1 T-piece - 1

Type	Artikel nr. Product no.	Gewicht Weight
TP-1	98143.203	0,45

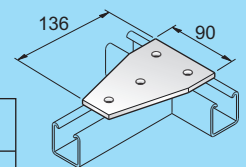

TP-1

## Kruisstuk Cross-piece

Type	Artikel nr. Product no.	Gewicht Weight
KP-1	98144.203	0,47

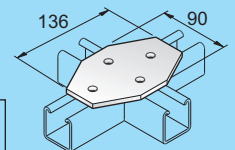

KP-1

## T-stuk - 2 T-piece - 2

Type	Artikel nr. Product no.	Gewicht Weight
TP-2	98119.203	0,31

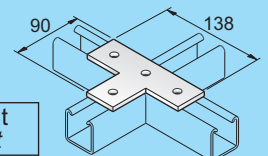

TP-2

## Verticaal T-stuk Vertical T-piece

Type	Artikel nr. Product no.	Gewicht Weight
VTP-1	98113.203	0,45

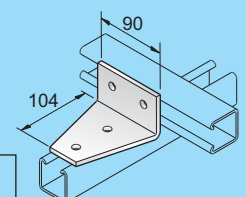

VTP-1

### Verticaal T-stuk Vertical T-piece

Type	Artikel nr. Product no.	Gewicht Weight
VTP-2	98115.203	0,67

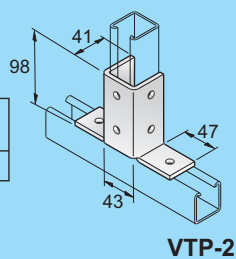

VTP-2

### Hoekstuk vlak 90° Corner piece flat 90°

Type	Artikel nr. Product no.	Gewicht Weight
HP-1	98140.203	0,25

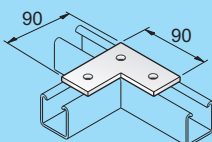

HP-1

### Hoekbeugel 90° - 2 gaten Corner brace 90° - 2 holes

Type	Artikel nr. Product no.	Gewicht Weight
VP-2	98111.203	0,15

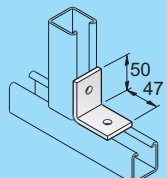

VP-2

### Hoekbeugel 90° - 3 gaten Corner brace 90° - 3 holes

Type	Artikel nr. Product no.	Gewicht Weight
VP-3	98112.203	0,24

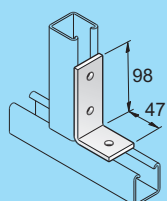

VP-3

### Hoekbeugel 90° - 4 gaten Corner brace 90° - 4 holes

Type	Artikel nr. Product no.	Gewicht Weight
VP-4	98116.203	0,32

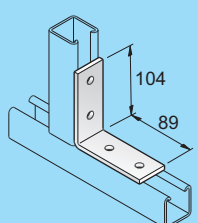

VP-4

### Hoekbeugel buiten 45° Corner brace outer 45°

Type	Artikel nr. Product no.	Gewicht Weight
VP-5	98109.203	0,25

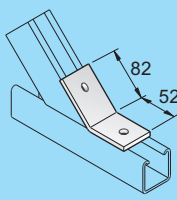

VP-5

### Hoekbeugel binnen 45° Corner brace inner 45°

Type	Artikel nr. Product no.	Gewicht Weight
VP-6	98142.203	0,25

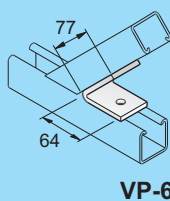

VP-6

### Klembeugel dubbel B21 Clamp brace double B21

Type	Artikel nr. Product no.	Gewicht Weight
KBD-21	98133.203	0,29

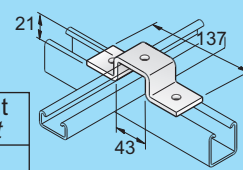

KBD-21

### Klembeugel dubbel B41 Clamp brace double B41

Type	Artikel nr. Product no.	Gewicht Weight
KBD-41	98134.203	0,34

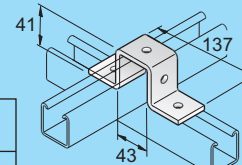

KBD-41

### Klembeugel enkel B21 Clamp brace single B21

Type	Artikel nr. Product no.	Gewicht Weight
KBE-21	98131.203	0,19

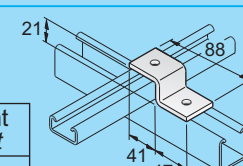

KBE-21

### Klembeugel enkel B41 Clamp brace single B41

Type	Artikel nr. Product no.	Gewicht Weight
KBE-41	98132.203	0,22

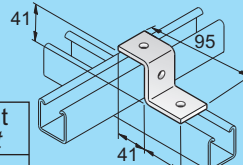

KBE-41

### Vloerbeugel Floor brace

Type	Artikel nr. Product no.	Gewicht Weight
VB-1	98120.203	0,58

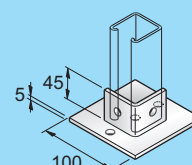

VB-1

### Spanklauw Beam clamp

Type	Artikel nr. Product no.	Gewicht Weight
SK-A	98548.203	0,10

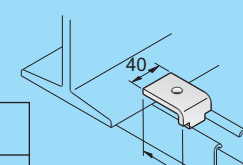

SK-A

### Spanklauw Beam clamp

Type	Artikel nr. Product no.	Gewicht Weight
SK-B	98546.203	0,11

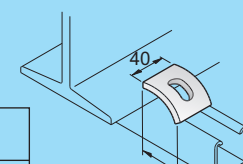

SK-B

### Draagbalkklem Beam clamp

L	Artikel nr. Product no.	Gewicht Weight
21-41	98961.203	0,36
62-83	98963.203	0,40

