



Kabelkanalen - Cable ducts

E

bevestigingsmateriaal *fastening products*

# Gouda Holland





# Kabelkanalen Cable ducts



**bevestigingsmateriaal**

*fastening products*



Bev. mat.

# Bevestigingsmateriaal

*Fastening products*

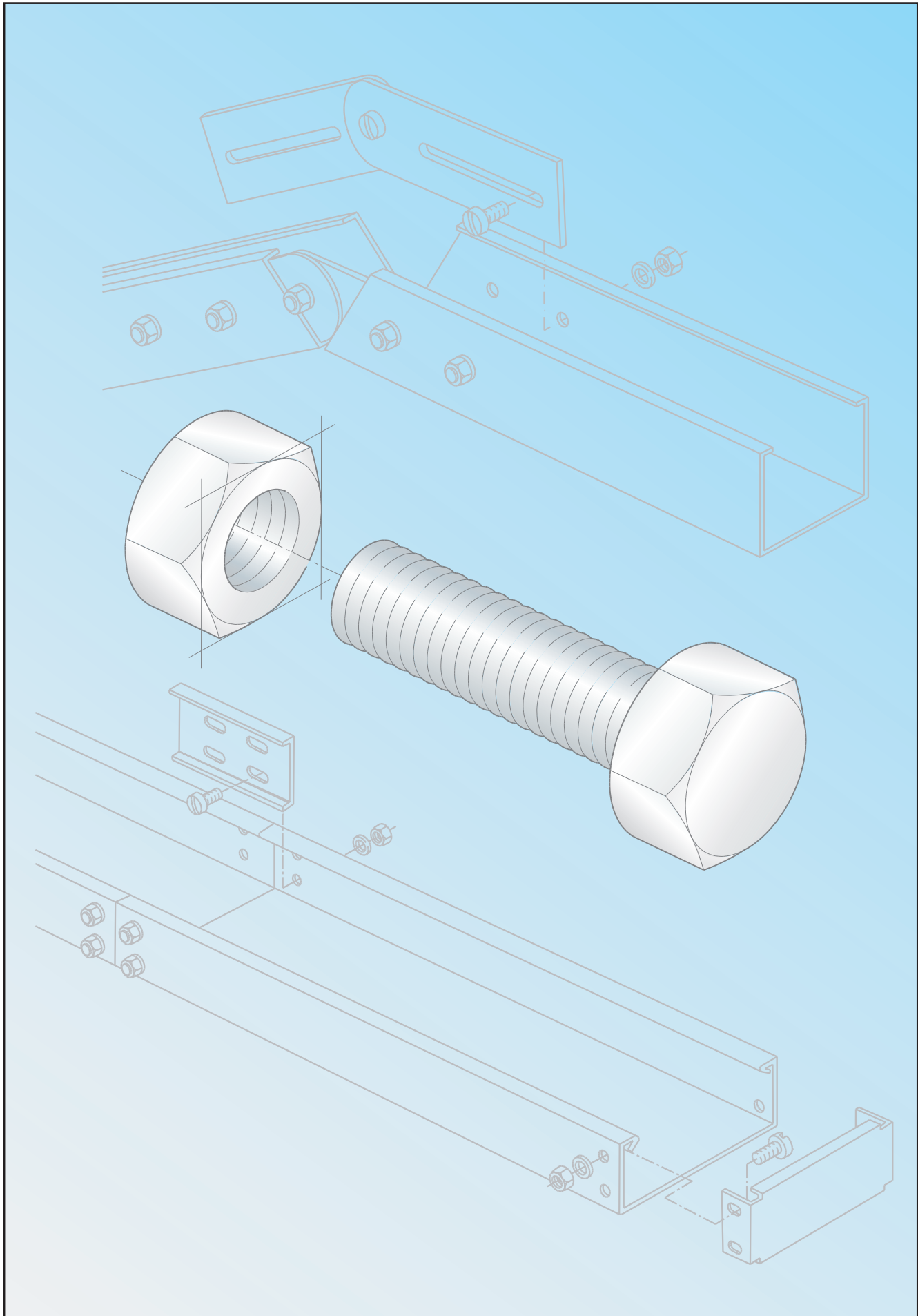

Bev. mat.

### Bolcilinderkopschroef Slotted pan head screw



DIN 85

Artikel nr. Product no.	
Maat Size	RVS SS
M 5 x 10	99755.204
M 5 x 16	99757.204
M 6 x 16	99763.204
M 6 x 20	99764.204
M 8 x 12	99767.204

### Tapbout Tap bolt (Hex. head screw)



DIN 933

Artikel nr. Product no.	
Maat Size	RVS SS
M 6 x 20	99776.204
M 6 x 25	99777.204
M 10 x 20	99791.204
M 10 x 25	99792.204
M 10 x 30	99793.204
M 10 x 40	99794.204
M 10 x 50	99795.204
M 10 x 70	99797.204

### Slotbout Lock screw (Mushroom head square neck screw)



RVS 316  
SS 316

Artikel nr. Product no.	
Maat Size	RVS SS
M 6 x 12	99808.204
M 8 x 16	99831.204
M 10 x 20	99839.206

### Ckk. plaatschroef C.h. tapping screw



DIN 7981

Artikel nr. Product no.	
Maat Size	RVS SS
3.5 x 13	99917.204
4.2 x 13	99922.204

### Draadstang Threaded rod

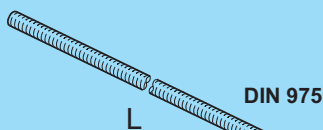

DIN 975

Artikel nr. Product no.	
Maat Size	RVS SS
M 8 x 1000	99863.204
M 8 x 3000	99864.204
M 10 x 3000	99867.204

### Pendel M10 Hanger rod M10

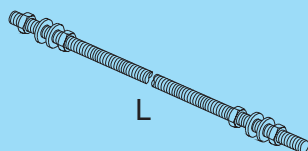

L

Artikel nr. Product no.	
L	RVS SS
500	99875.204
1000	99880.204
1500	99881.204
2000	99882.204
3000	99883.204

levering inclusief: moeren M10  
en sluitringen

supplied complete with: nuts M10  
and washers

### Flensmoer Flange nut



DIN 6923

Artikel nr. Product no.	
Maat Size	RVS SS
M 5	99811.204
M 6	99812.204
M 8	99813.204

### Moer Nut



DIN 934

Artikel nr. Product no.	
Maat Size	RVS SS
M 6	99816.204
M 8	99817.204
M 10	99818.204

### Verbindingsmoer Connection nut

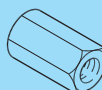

Artikel nr. Product no.	
Maat Size	RVS SS
M 8 x 25	99829.204
M 10 x 25	99830.204

### Sluitring Washer



DIN 125A

Artikel nr. Product no.	
Maat Size	RVS SS
M 6	99841.204
M 8	99842.204
M 10	99843.204

### Carrosseriering Fender washer



DIN 9021

Artikel nr. Product no.	
Maat Size	RVS SS
M 5	99848.204
M 6	99849.204
M 8	99850.204
M 10	99851.204

### Slotbout - 8 sets Lock screw - 8 sets (Mushroom head square neck screw)



RVS 316  
SS 316

Artikel nr. Product no.	
Maat Size	RVS SS
M 10 x 20	99809.206



### Bolcilinderkopschroef Slotted pan head screw



DIN 85

Artikel nr. Product no.	
Maat Size	El. verz. HDMG
M 5 x 10	99755.201
M 5 x 16	99757.201
M 6 x 16	99763.201
M 6 x 20	99764.201
M 8 x 12	99767.201

### Tapbout Tap bolt (Hex. head screw)

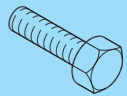

DIN 933

Artikel nr. Product no.	
Maat Size	El. verz. HDMG
M10 x 20	99791.201
M10 x 25	99792.201
M10 x 30	99793.201
M10 x 40	99794.201
M10 x 70	99797.201

### Slotbout Lock screw (Mushroom head square neck screw)

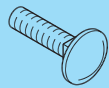

Artikel nr. Product no.	
Maat Size	El. verz. HDMG
M 6 x 12	99808.201

### Ckk. plaatschroef C.h. tapping screw



DIN 7981

Artikel nr. Product no.	
Maat Size	El. verz. HDMG
3.5 x 13	99917.201

### Draadstang Threaded rod

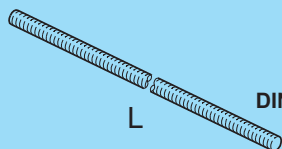

DIN 975

Artikel nr. Product no.	
Maat Size	El. verz. HDMG
M 8 x 1000	99863.201
M 8 x 3000	99864.201
M10 x 1000	99865.201
M10 x 3000	99867.201

### Pendel M10 Hanger rod M10

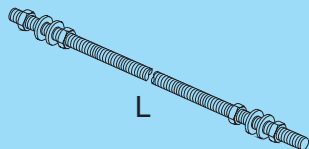

Artikel nr. Product no.	
L	El. verz. HDMG
500	99875.201
1000	99880.201
1500	99881.201
2000	99882.201
3000	99883.201

levering inclusief: moeren M10  
en sluitringen

supplied complete with: nuts M10  
and washers

### Flensmoer Flange nut



DIN 6923

Artikel nr. Product no.	
Maat Size	El. verz. HDMG
M 5	99811.201
M 6	99812.201

### Moer Nut



DIN 934

Artikel nr. Product no.	
Maat Size	El. verz. HDMG
M 6	99816.201
M 8	99817.201
M10	99818.201

### Verbindingsmoer Connection nut

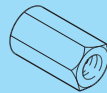

Artikel nr. Product no.	
Maat Size	El. verz. HDMG
M 8 x 25	99829.201
M10 x 30	99830.201

### Sluitring Washer



DIN 125A

Artikel nr. Product no.	
Maat Size	El. verz. HDMG
M 8	99842.201
M10	99843.201

### Carrosseriering Fender washer



DIN 9021

Artikel nr. Product no.	
Maat Size	El. verz. HDMG
M 6	99849.201
M 8	99850.201
M10	99851.201

### Tapbout Tap bolt (Hex. head screw)

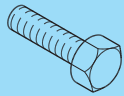

DIN 933

Artikel nr. Product no.	
Maat Size	Th.verz. HDGAF
M 8 x 30	99783.203
M10 x 20	99791.203
M10 x 25	99792.203
M10 x 30	99793.203
M10 x 40	99794.203
M10 x 50	99795.203

### Slotbout Lock screw (Mushroom head square neck screw)

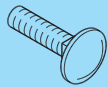

Dacromet

Artikel nr. Product no.	
Maat Size	Th.verz. HDGAF
M 6 x 12	99808.203

### Slotbout Lock screw (Mushroom head square neck screw)



Artikel nr. Product no.	
Maat Size	Th.verz. HDGAF
M 10 x 20	99839.203

### Draadstang Threaded rod

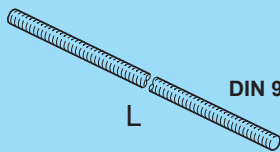

DIN 975

Artikel nr. Product no.	
Maat Size	Th.verz. HDGAF
M10 x 1000	99865.203

### Flensmoer Flange nut



DIN 6923 Dacromet

Artikel nr. Product no.	
Maat Size	Th.verz. HDGAF
M 6	99812.203

### Moer Nut



DIN 934

Artikel nr. Product no.	
Maat Size	Th.verz. HDGAF
M10	99818.203

### Sluitring Washer



DIN 125A

Artikel nr. Product no.	
Maat Size	Th.verz. HDGAF
M 6	99841.203
M 8	99842.203
M10	99843.203

### Carrosseriering Fender washer



DIN 9021

Artikel nr. Product no.	
Maat Size	Th.verz. HDGAF
M 5	99848.203
M 6	99849.203
M 8	99850.203
M10	99851.203

### Slotbout - 8 sets Lock screw - 8 sets (Mushroom head square neck screw)

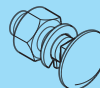

Artikel nr. Product no.	
Maat Size	Th.verz. HDGAF
M10 x 20	99809.203

### Spuitbus Spray

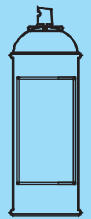

400 ml

Artikel nr. Product no.	
Inhoud Content	
Lak RAL 9002	99991.217
Zinkspray MAT	99992.207
Zinkspray GLANS	99993.207

### Dekselveer - V Cover spring - V

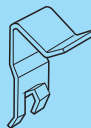

Verenstaal  
Springsteel

Artikel nr. Product no.	
Maat Size	Verenstaal Springsteel
	99979.209

\* t.b.v. Unic/Resist systeem  
\* i.b.o. Unic/Resist systeem

### Randbeschermingsprofiel Flexible edge protector



grijs  
grey

9

Artikel nr. Product no.	
Maat Size	
H=9	99944.207

Bereik 1-2 mm  
Clamping range 1-2 mm

### Isolatiestrip Insulation strip



Artikel nr. Product no.	
Maat Size	Kunststof Synthetic
1000x25x3 pp	99946.207
40x20x10 pp	99950.207
1200x25x2 ptfe	99947.207
40x20x10 rol ptfe	99948.207
13mx50mm x0,5mm	99945.207

# Bevestigingsmateriaal

## Fastening products

### Aardingslitze

#### Bounding jumper

Artikel nr. Product no.	
Maat Size	Koper vertind Tin-plated copper
M 6/ 6mm <sup>2</sup>	99975.209
M 8/16mm <sup>2</sup>	99977.209
M10/25mm <sup>2</sup>	99978.209



### Afdichtstop

#### Seal cap

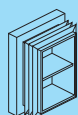

zwart  
black

Artikel nr. Product no.	
Maat Size	PVC
40 x 20*	99951.207
40 x 30	99954.207
60 x 20*	99952.207
60 x 30	99955.207
80 x 40	99956.207

\* t.b.v. Streamline systeem  
\* i.b.o. Streamline system

### Beschermkap - R

#### Protection cap - R

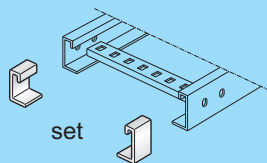

set

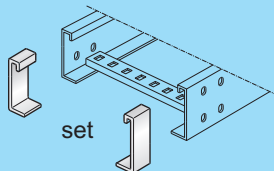

set

Artikel nr. Product no.	
Maat Size	PVC
H60	56090.207
H100	56390.207

t.b.v. Resist systeem  
i.b.o. Resist system

zacht PVC  
flexible PVC

geel 903  
yellow 903

### Beschermkap - C

#### Protection cap - C

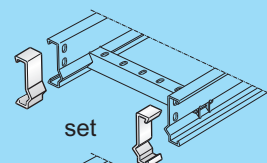

set

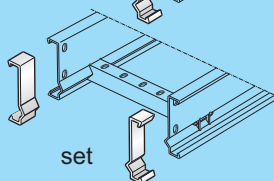

set

Artikel nr. Product no.	
Maat Size	PVC
H100	64060.207
H130	65060.207

t.b.v. Crafty systeem  
i.b.o. Crafty system

zacht PVC  
flexible PVC

geel 903  
yellow 903

### Beschermkap - CMF

#### Protection cap - CMF

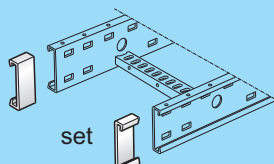

set

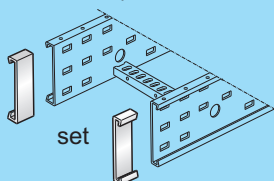

set

Artikel nr. Product no.	
Maat Size	PVC
H100	71060.207
H150	72060.207

t.b.v. Crafty MF systeem  
i.b.o. Crafty MF system

zacht PVC  
flexible PVC

geel 903  
yellow 903







## **GoudaHolland B.V.**

Grote Esch 80  
2841 MJ Moordrecht  
The Netherlands

P.O. Box 200  
2800 AE Gouda  
The Netherlands

tel. +31 (0) 182-506200

[www.goudaholland.nl](http://www.goudaholland.nl)  
[info@goudaholland.nl](mailto:info@goudaholland.nl)



**GoudaHolland**

