



Kabelkanalen - Cable ducts

roestvaststaal

stainless steel

B

Scheepsladder H30

Marine ladder H30

Gouda Holland

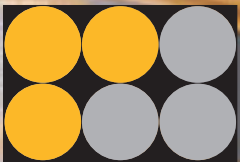

GoudaHolland

Kabelkanalen
Cable ducts

Scheepsladder H30
Marine ladder H30



kabelladder

roestvaststaal

cable ladder

stainless steel



Det Norske Veritas (DNV) en Germanischer Lloyd (GL)



Scheepsladder

Scheepsladder

H30

Kabelladder, Roestvaststaal

Marine ladder

H30

Cable ladder, Stainless steel

- chemisch resistent (gebeitst en gepassiviseerd)
- kwaliteit AISI 316 (BS 316 S / WL Norm 1.4404)
- standaardlengte 3000 mm
- standaard eenzijdig gelast

Op verzoek:

- afwijkende breedte- en lengtematen
- hulpstukken $R \geq 100/150$ mm
- afwijkende bodemprofielen

- *chemically resistant (pickled and passivated)*
- *AISI 316 (BS 316 S / WL Standard 1.4404) quality*
- *standard length 3000 mm*
- *standard welded on one side*

On request:

- *deviant width and length*
- *fittings $R \geq 100/150$ mm*
- *deviating base sections*

Scheepsladder H30 / Marine ladder H30

Met koppelgaten / With coupling holes

Bodemprofielen h.o.h. 250 mm
Rung distance c.t.c. 250 mm

- materiaaldikte zijwand 5 mm
- materiaaldikte bodemprofiel 3 mm
- hulpstukken $R = 100/150$

- *material thickness sidewall 5 mm*
- *material thickness base section 3 mm*
- *fittings $R = 100/150$*

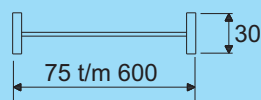

overspanning tot max. 3 meter
max. span: 3 mtr.

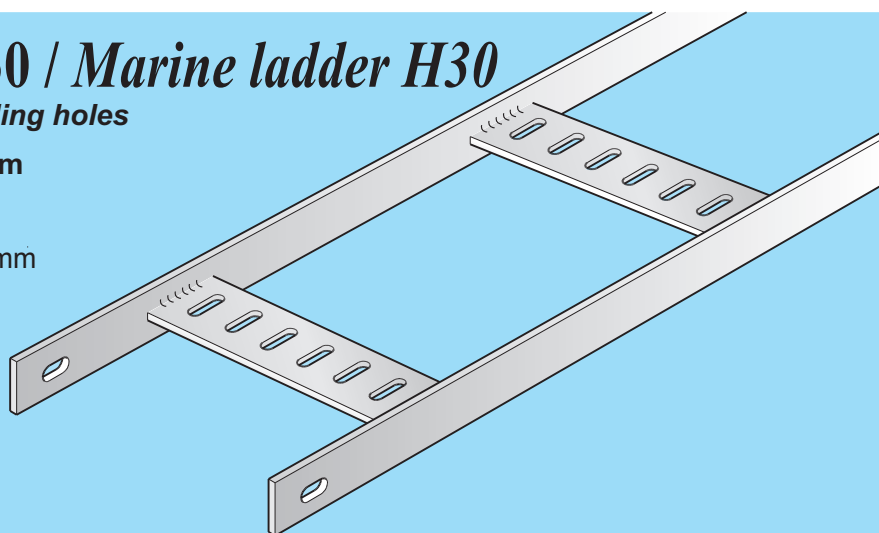

Scheepsladder H30 / Marine ladder H30

Zonder koppelgaten / Without coupling holes

Bodemprofielen h.o.h. 250 mm
Rung distance c.t.c. 250 mm

- materiaaldikte zijwand 5 mm
- materiaaldikte bodemprofiel 3 mm
- hulpstukken $R = 100/150$

- *material thickness sidewall 5 mm*
- *material thickness base section 3 mm*
- *fittings $R = 100/150$*

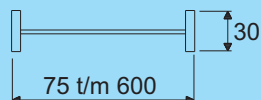

overspanning tot max. 3 meter
max. span: 3 mtr.

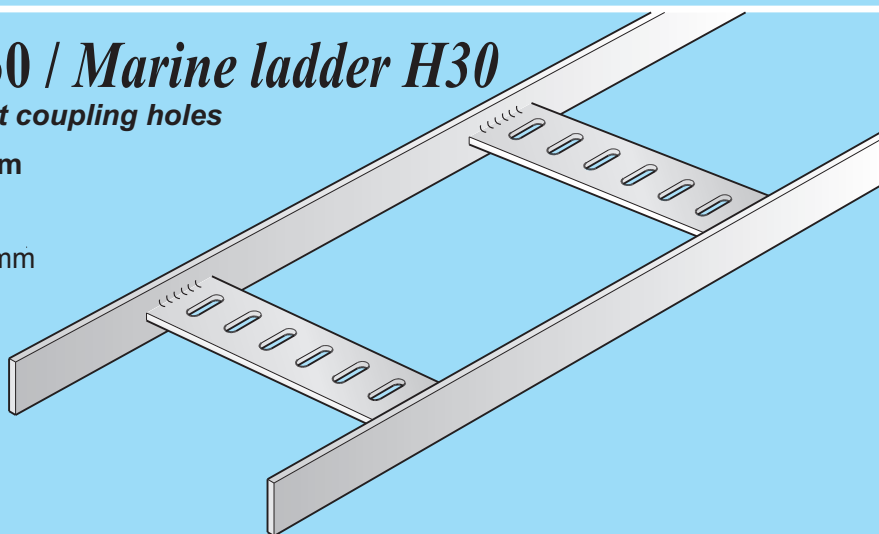

Kabelkanalen Scheepsladder

Cable ducts Marine ladder

Kabelladder, Roestvaststaal

Cable ladder, Stainless steel

B7-1 Algemeen

- Inhoudsopgave
- Technische gegevens
- Systemoverzicht

Pag.

B7-1-2
B7-1-3
B7-1-4

B7-1 General

- *Table of contents*
- *Technical specifications*
- *Survey of the system*

Page

*B7-1-2
B7-1-3
B7-1-4*

B7-2 Scheepsladder H30

- Kabelladders/Koppelplaten
- Hulpstukken

B7-2-1
B7-2-2/3

B7-2 Marine ladder H30

- *Cable ladders/Splice plates*
- *Fittings*

*B7-2-1
B7-2-2/3*

B7-3 Scheepsladder H30

- Kabelladders/Koppelplaten
- Hulpstukken

B7-3-1
B7-3-2/3

B7-3 Marine ladder H30

- *Cable ladders/Splice plates*
- *Fittings*

*B7-3-1
B7-3-2/3*

Technische gegevens

Technical specifications

Kenmerken

Features

Materiaal kwaliteit

De kabelladders, koppelplaten, hulpstukken, alsmede de ophang-inrichtingen worden vervaardigd uit roestvaststaal in de kwaliteit AISI 316. De bevestigingsmaterialen zijn van A4 handelskwaliteit.

Material Quality

The cable ladders, splice plates, fittings, and suspension constructions are fabricated in stainless steel, quality AISI 316. The attachment materials are made of A4 quality.

Systeem

Scheepsladder is een “medium duty” kabelladder-systeem. Scheepsladder wordt geleverd in lengten van 3000 mm.

System

Marine ladder is a “medium duty” cable ladder system. Marine ladder is supplied in lengths of 3000 mm.

De ladderbodem is voorzien van geperforeerde bodemprofielen, aangebracht op een hartafstand van 250 mm.

The ladder bottom is provided with perforated bottom profiles placed on a centre distance of 250 mm.

Het bodemprofiel en de zijwanden worden middels een lasconstructie aan elkaar bevestigd.

The base section and side walls are connected through a welding construction.

Hulpstukken

Hulpstukken worden geleverd met een standaard radius van 100 of 150 mm. Het systeem kan worden gecompleteerd met diverse plafond- en wandbevestigingen (zie hoofdstuk **E**).

Fittings

*Fittings are supplied with a standard radius of 100 or 150 mm. The system can be completed with several ceiling- and wall-attachments (see chapter **E**).*

Scheepsladder H30 met koppelgaten
Marine ladder H30 with coupling holes

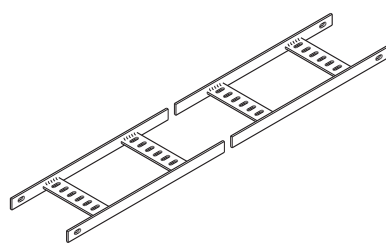

Koppelplaat - set
Splice plate - set

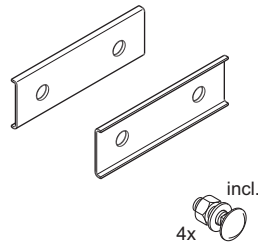

Scharn. koppelplaat - set
Hinged splice plate - set

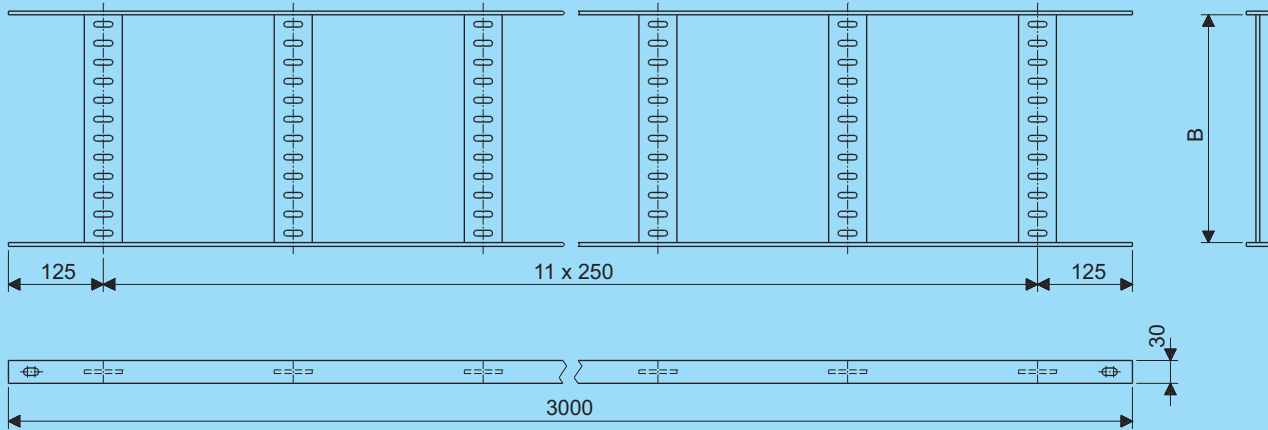
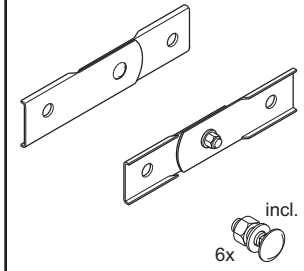

bestel de benodigde koppelplaten en bevestigingsmaterialen apart, zij worden niet geleverd bij de kanalen

order splice plates and fastening products as separate items, they are not supplied with the cable ducts

Scheepsladder H30 met koppelgaten
Marine ladder H30 with coupling holes

B	Artikel nr. Product no.		Gewicht Weight
	Enkel gelast Single welded	Rondom gelast Welded around	
75	26000.236	26020.236	8,09
100	26001.236	26021.236	8,38
150	26002.236	26022.236	8,98
200	26003.236	26023.236	9,55
250	26004.236	26024.236	10,18
300	26005.236	26025.236	10,75
400	26006.236	26026.236	11,93
500	26007.236	26027.236	13,10
600	26008.236	26028.236	14,28

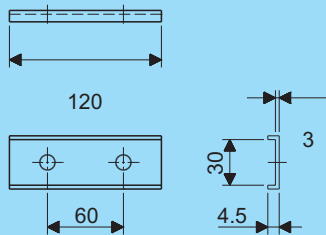

Koppelplaat - set
Splice plate - set

Artikel nr. Product no.	Gewicht Weight
26500.206	0,39

levering inclusief:
4 slotbouten M10 x 20,
moeren en sluitringen

supplied complete with:
4 lock screws M10 x 20,
nuts and washers

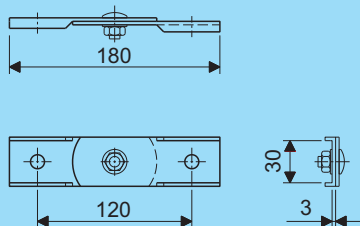

Scharn. koppelplaat - set
Hinged splice plate - set

Artikel nr. Product no.	Gewicht Weight
26510.206	0,72

levering inclusief:
6 slotbouten M10 x 20,
moeren en sluitringen

supplied complete with:
6 lock screws M10 x 20,
nuts and washers

Scheepsladder

Marine ladder

H30

Horizontaal bochtstuk 90° met koppelgaten
Horizontal bend 90° with coupling holes

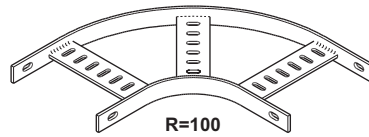

Aftakstuk met koppelgaten
Branch with coupling holes

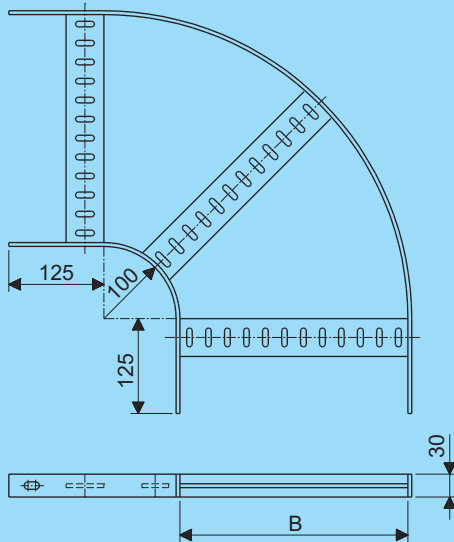
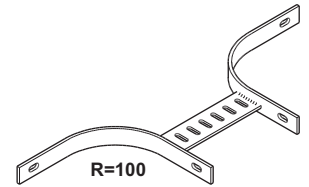

Horizontaal bochtstuk 90° met koppelgaten
Horizontal bend 90° with coupling holes

B	Artikel nr. Product no.		Gewicht Weight
	Enkel gelast Single welded	Rondom gelast Welded around	
75	26100.236	26120.236	1,33
100	26101.236	26121.236	1,45
150	26102.236	26122.236	1,69
200	26103.236	26123.236	1,93
250	26104.236	26124.236	2,18
300	26105.236	26125.236	2,41
400	26106.236	26126.236	3,29
500	26107.236	26127.236	3,87
600	26108.236	26128.236	4,45

bestel de benodigde
koppelplaten apart

order splice plates as
separate items

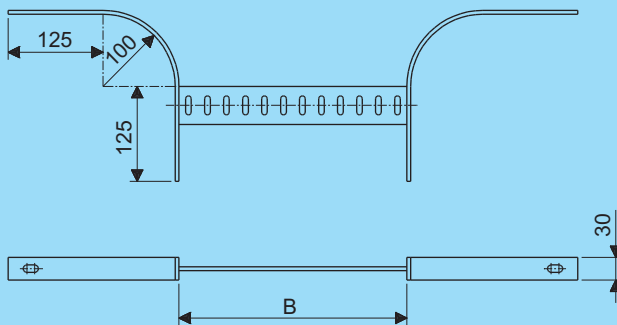

Aftakstuk met koppelgaten
Branch with coupling holes

B	Artikel nr. Product no.		Gewicht Weight
	Enkel gelast Single welded	Rondom gelast Welded around	
75	26200.236	26220.236	1,03
100	26201.236	26221.236	1,06
150	26202.236	26222.236	1,11
200	26203.236	26223.236	1,16
250	26204.236	26224.236	1,21
300	26205.236	26225.236	1,26
400	26206.236	26226.236	1,35
500	26207.236	26227.236	1,45
600	26208.236	26228.236	1,55

bestel de benodigde
koppelplaten apart

order splice plates as
separate items

Scheepsladder

Marine ladder

H30

Driewegstuk met koppelgaten
Equal tee piece with coupling holes

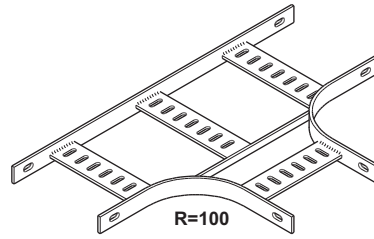

Stijg-vervalstuk 90° met koppelgaten
Inner-outer bend 90° with coupling holes

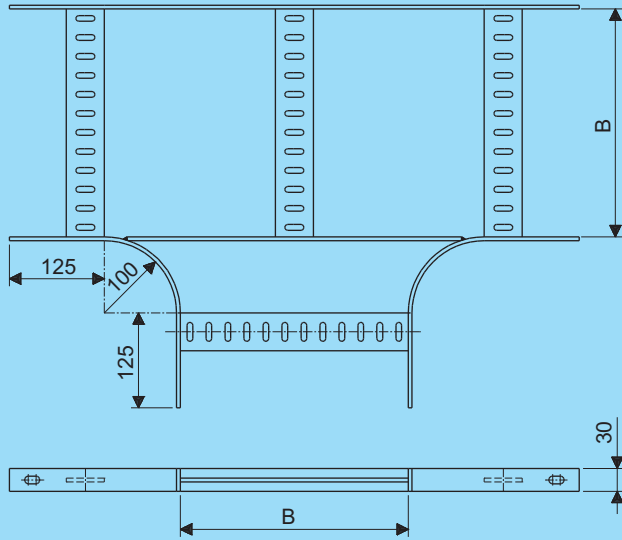
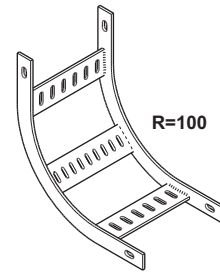

Driewegstuk met koppelgaten Equal tee piece with coupling holes			
Enkel gelast Single welded		Rondom gelast Welded around	
B	Artikel nr. Product no.	Gewicht Weight	
75	26300.236	26320.236	2,07
100	26301.236	26321.236	2,22
150	26302.236	26322.236	2,52
200	26303.236	26323.236	2,81
250	26304.236	26324.236	3,11
300	26305.236	26325.236	3,40
400	26306.236	26326.236	4,38
500	26307.236	26327.236	5,07
600	26308.236	26328.236	5,76

bestel de benodigde
koppelplaten apart

order splice plates as
separate items

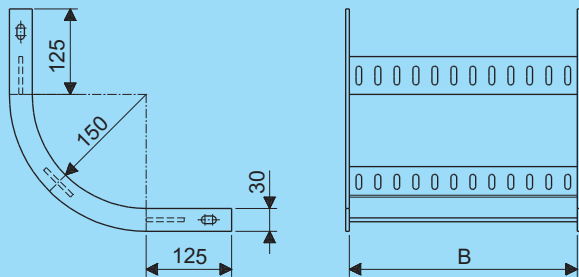

Stijg-vervalstuk 90° met koppelgaten Inner-outer bend 90° with coupling holes			
Enkel gelast Single welded		Rondom gelast Welded around	
B	Artikel nr. Product no.	Gewicht Weight	
75	26400.236	26420.236	1,39
100	26401.236	26421.236	1,46
150	26402.236	26422.236	1,61
200	26403.236	26423.236	1,75
250	26404.236	26424.236	1,91
300	26405.236	26425.236	2,05
400	26406.236	26426.236	2,35
500	26407.236	26427.236	2,64
600	26408.236	26428.236	2,93

bestel de benodigde
koppelplaten apart

order splice plates as
separate items

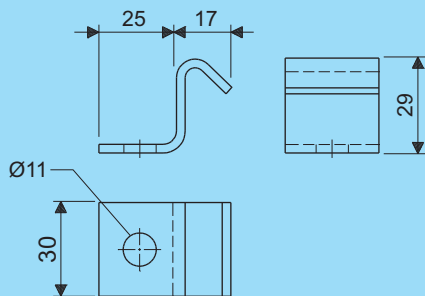

Bevestigingsbeugel Hold down clip		
Artikel nr. Product no.	Gewicht Weight	
98671.206	2,34	

Scheepsladder

Marine ladder

H30

Scheepsladder H30 zonder koppelgaten
Marine ladder H30 without coupling holes

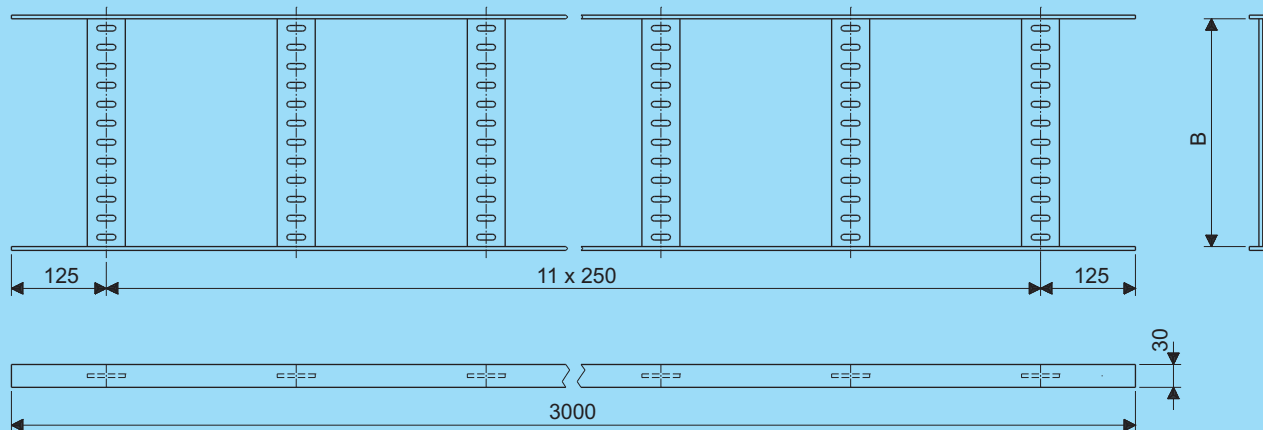
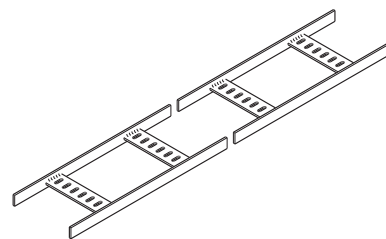

Scheepsladder H30 zonder koppelgaten
Marine ladder H30 without coupling holes

B	Artikel nr. Product no.		Gewicht Weight
	Enkel gelast Single welded	Rondom gelast Welded around	
75	26010.236	26030.236	8,09
100	26011.236	26031.236	8,38
150	26012.236	26032.236	8,98
200	26013.236	26033.236	9,55
250	26014.236	26034.236	10,18
300	26015.236	26035.236	10,75
400	26016.236	26036.236	11,93
500	26017.236	26037.236	13,10
600	26018.236	26038.236	14,28

Scheepsladder

Marine ladder

H30

Horizontaal bochtstuk 90° zonder koppelgaten
Horizontal bend 90° without coupling holes

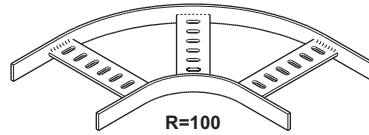

Aftakstuk zonder koppelgaten
Branch without coupling holes

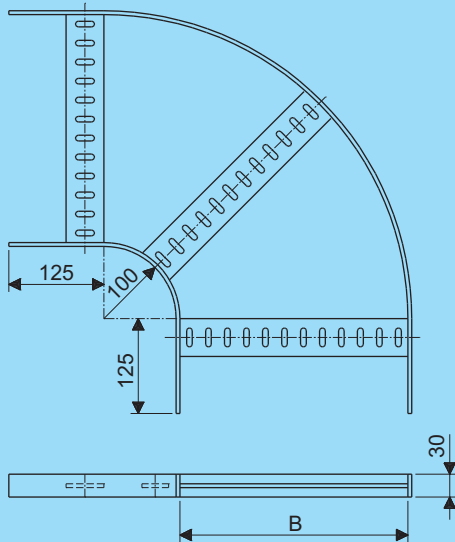
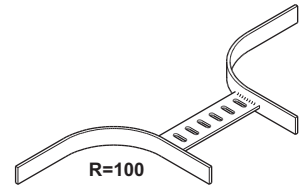

Hor. bochtstuk 90° zonder koppelgaten Hor. bend 90° without coupling holes			
Enkel gelast Single welded		Rondom gelast Welded around	
B	Artikel nr. Product no.		Gewicht Weight
75	26110.236	26130.236	1,33
100	26111.236	26131.236	1,45
150	26112.236	26132.236	1,69
200	26113.236	26133.236	1,93
250	26114.236	26134.236	2,18
300	26115.236	26135.236	2,41
400	26116.236	26136.236	3,29
500	26117.236	26137.236	3,87
600	26118.236	26138.236	4,45

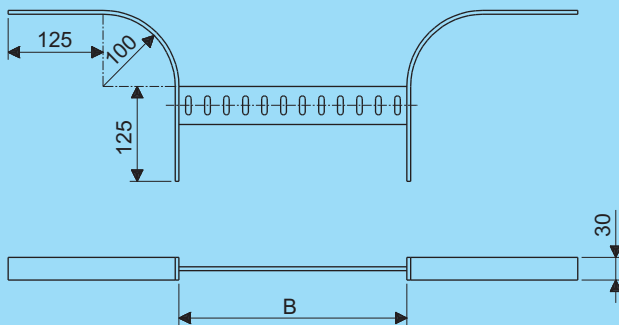

Aftakstuk zonder koppelgaten Branch without coupling holes			
Enkel gelast Single welded		Rondom gelast Welded around	
B	Artikel nr. Product no.		Gewicht Weight
75	26210.236	26230.236	1,03
100	26211.236	26231.236	1,06
150	26212.236	26232.236	1,11
200	26213.236	26233.236	1,16
250	26214.236	26234.236	1,21
300	26215.236	26235.236	1,26
400	26216.236	26236.236	1,35
500	26217.236	26237.236	1,45
600	26218.236	26238.236	1,55

Scheepsladder

Marine ladder

H30

Driewegstuk zonder koppelgaten
Equal tee piece without coupling holes

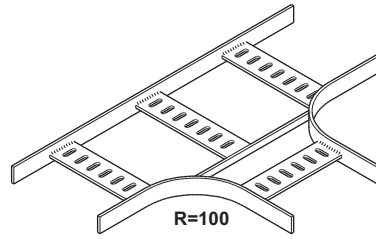

Stijg-vervalstuk 90° zonder koppelgaten
Inner-outer bend 90° without coupling holes

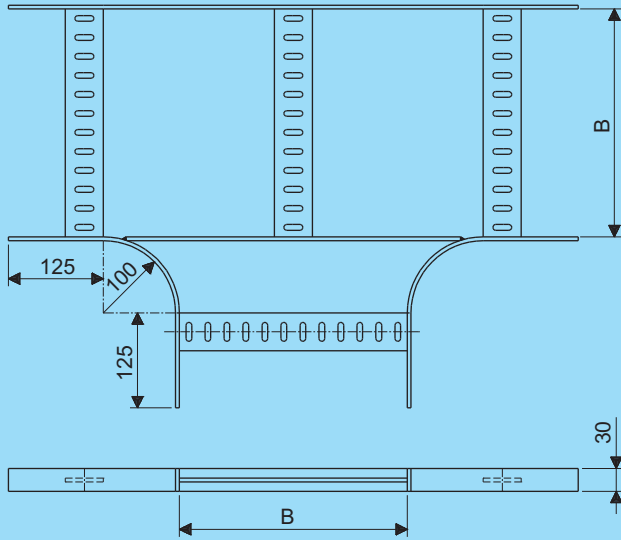
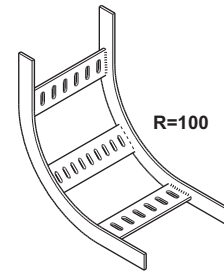

Driewegstuk zonder koppelgaten Equal tee piece without coupling holes			
Enkel gelast Single welded		Rondom gelast Welded around	
B	Artikel nr. Product no.		Gewicht Weight
75	26310.236	26330.236	2,07
100	26311.236	26331.236	2,22
150	26312.236	26332.236	2,52
200	26313.236	26333.236	2,81
250	26314.236	26334.236	3,11
300	26315.236	26335.236	3,40
400	26316.236	26336.236	4,38
500	26317.236	26337.236	5,07
600	26318.236	26338.236	5,76

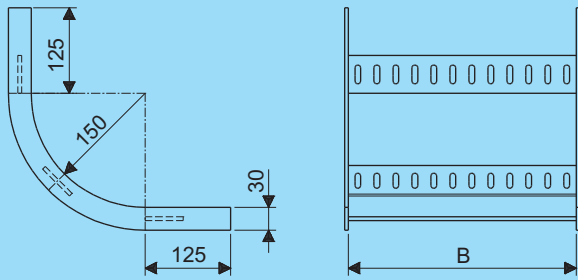

Stijg-vervalstuk 90° zonder koppelgaten Inner-outer bend 90° without coupling holes			
Enkel gelast Single welded		Rondom gelast Welded around	
B	Artikel nr. Product no.		Gewicht Weight
75	26410.236	26430.236	1,39
100	26411.236	26431.236	1,46
150	26412.236	26432.236	1,61
200	26413.236	26433.236	1,75
250	26414.236	26434.236	1,91
300	26415.236	26435.236	2,05
400	26416.236	26436.236	2,35
500	26417.236	26437.236	2,64
600	26418.236	26438.236	2,93



GoudaHolland B.V.

Grote Esch 80
2841 MJ Moordrecht
The Netherlands

P.O. Box 200
2800 AE Gouda
The Netherlands

tel. +31 (0) 182-506200

www.goudaholland.nl
info@goudaholland.nl



GoudaHolland

