

Strut materiaal

thermisch verzinkt

Strut material

hot dip galvanized



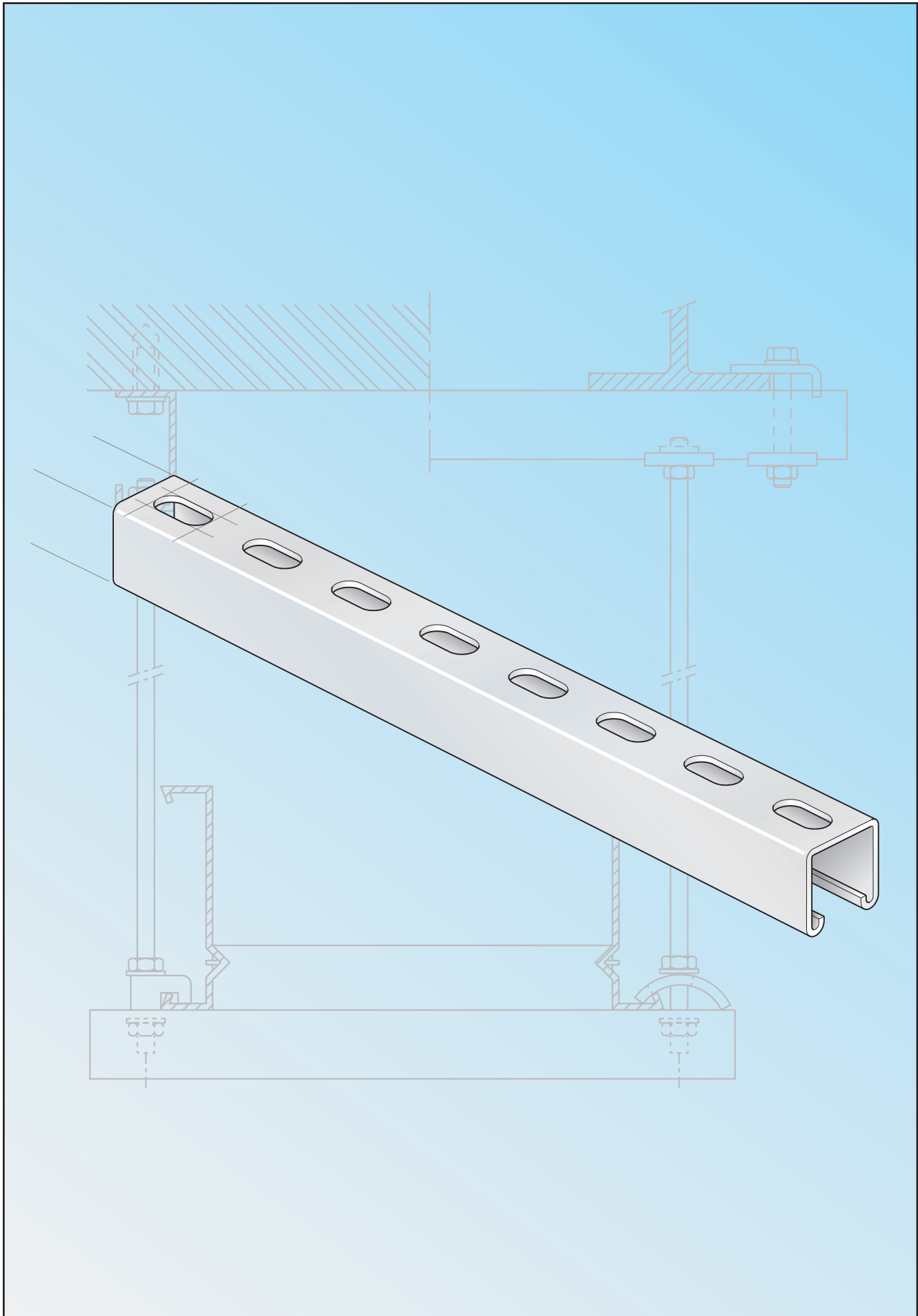

Montagerail = B21 Hanger channel = B21

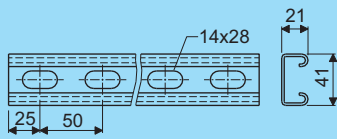

| L | Artikel nr. Product no. | Gewicht Weight |
|------|----------------------------|-------------------|
| 3000 | 98026.203 | 5,28 |
| 6000 | 98027.203 | 10,56 |

Montagerail = B41 Hanger channel = B41

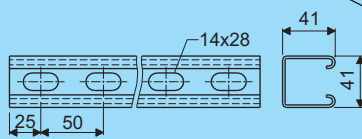

| L | Artikel nr. Product no. | Gewicht Weight |
|------|----------------------------|-------------------|
| 3000 | 98056.203 | 8,19 |
| 6000 | 98057.203 | 16,38 |

Afdichtstop Seal cap

| Type | Artikel nr. Product no. | Gewicht Weight |
|------|----------------------------|-------------------|
| B=21 | 99961.207 | 0,01 |
| B=41 | 99963.207 | 0,01 |

PVC
zwart / black

Moerplaat Nut plate

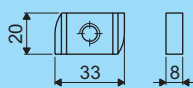

| Type | Artikel nr. Product no. | Gewicht Weight |
|------|----------------------------|-------------------|
| M6 | 98086.203 | 0,03 |
| M8 | 98088.203 | 0,04 |
| M10 | 98090.203 | 0,04 |

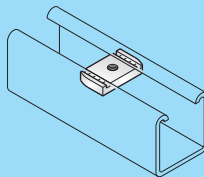
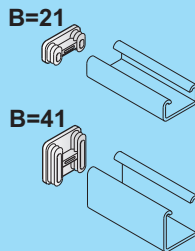
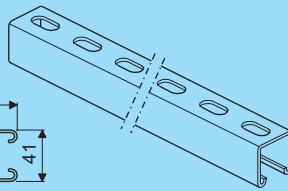
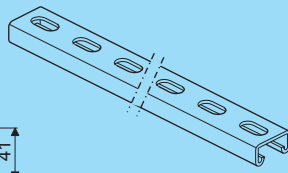

Montagestrip / Railplaat Mounting strip / Rail plate

| Type | Artikel nr. Product no. | Gewicht Weight |
|------|----------------------------|-------------------|
| MP-1 | 98078.203 | 0,07 |

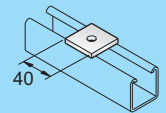

MP-1

Montagestrip - 2 gaten Mounting strip - 2 holes

| Type | Artikel nr. Product no. | Gewicht Weight |
|------|----------------------------|-------------------|
| MP-2 | 98101.203 | 0,16 |

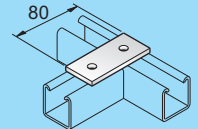

MP-2

Montagestrip - 3 gaten Mounting strip - 3 holes

| Type | Artikel nr. Product no. | Gewicht Weight |
|------|----------------------------|-------------------|
| MP-3 | 98103.203 | 0,24 |

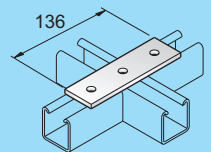

MP-3

Montagestrip - 4 gaten Mounting strip - 4 holes

| Type | Artikel nr. Product no. | Gewicht Weight |
|------|----------------------------|-------------------|
| MP-4 | 98105.203 | 0,32 |

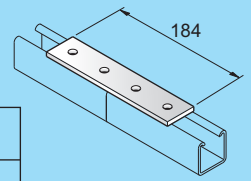

MP-4

T-stuk - 1 T-piece - 1

| Type | Artikel nr. Product no. | Gewicht Weight |
|------|----------------------------|-------------------|
| TP-1 | 98143.203 | 0,45 |

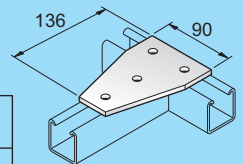

TP-1

Kruisstuk Cross-piece

| Type | Artikel nr. Product no. | Gewicht Weight |
|------|----------------------------|-------------------|
| KP-1 | 98144.203 | 0,47 |

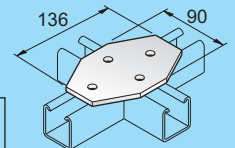

KP-1

T-stuk - 2 T-piece - 2

| Type | Artikel nr. Product no. | Gewicht Weight |
|------|----------------------------|-------------------|
| TP-2 | 98119.203 | 0,31 |

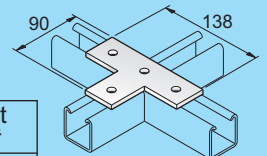

TP-2

Verticaal T-stuk Vertical T-piece

| Type | Artikel nr. Product no. | Gewicht Weight |
|-------|----------------------------|-------------------|
| VTP-1 | 98113.203 | 0,45 |

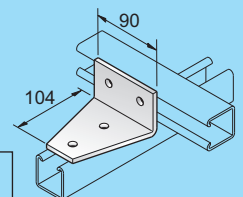

VTP-1

Verticaal T-stuk Vertical T-piece

| Type | Artikel nr. Product no. | Gewicht Weight |
|-------|----------------------------|-------------------|
| VTP-2 | 98115.203 | 0,67 |

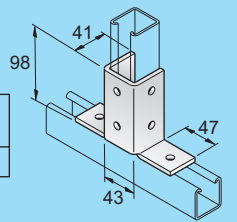

VTP-2

Hoekstuk vlak 90° Corner piece flat 90°

| Type | Artikel nr. Product no. | Gewicht Weight |
|------|----------------------------|-------------------|
| HP-1 | 98140.203 | 0,25 |

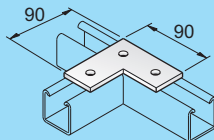

HP-1

Hoekbeugel 90° - 2 gaten Corner brace 90° - 2 holes

| Type | Artikel nr. Product no. | Gewicht Weight |
|------|----------------------------|-------------------|
| VP-2 | 98111.203 | 0,15 |

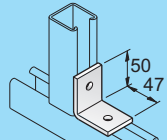

VP-2

Hoekbeugel 90° - 3 gaten Corner brace 90° - 3 holes

| Type | Artikel nr. Product no. | Gewicht Weight |
|------|----------------------------|-------------------|
| VP-3 | 98112.203 | 0,24 |

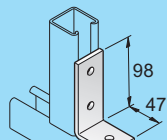

VP-3

Hoekbeugel 90° - 4 gaten Corner brace 90° - 4 holes

| Type | Artikel nr. Product no. | Gewicht Weight |
|------|----------------------------|-------------------|
| VP-4 | 98116.203 | 0,32 |

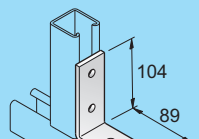

VP-4

Hoekbeugel buiten 45° Corner brace outer 45°

| Type | Artikel nr. Product no. | Gewicht Weight |
|------|----------------------------|-------------------|
| VP-5 | 98109.203 | 0,25 |

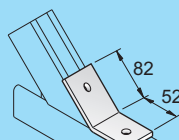

VP-5

Hoekbeugel binnen 45° Corner brace inner 45°

| Type | Artikel nr. Product no. | Gewicht Weight |
|------|----------------------------|-------------------|
| VP-6 | 98142.203 | 0,25 |

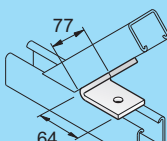

VP-6

Klembeugel dubbel B21 Clamp brace double B21

| Type | Artikel nr. Product no. | Gewicht Weight |
|--------|----------------------------|-------------------|
| KBD-21 | 98133.203 | 0,29 |

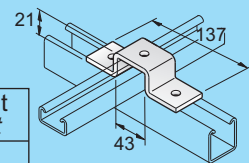

KBD-21

Klembeugel dubbel B41 Clamp brace double B41

| Type | Artikel nr. Product no. | Gewicht Weight |
|--------|----------------------------|-------------------|
| KBD-41 | 98134.203 | 0,34 |

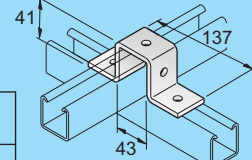

KBD-41

Klembeugel enkel B21 Clamp brace single B21

| Type | Artikel nr. Product no. | Gewicht Weight |
|--------|----------------------------|-------------------|
| KBE-21 | 98131.203 | 0,19 |

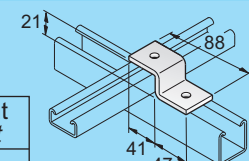

KBE-21

Klembeugel enkel B41 Clamp brace single B41

| Type | Artikel nr. Product no. | Gewicht Weight |
|--------|----------------------------|-------------------|
| KBE-41 | 98132.203 | 0,22 |

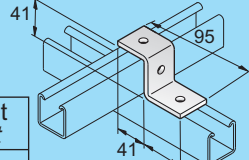

KBE-41

Vloerbeugel Floor brace

| Type | Artikel nr. Product no. | Gewicht Weight |
|------|----------------------------|-------------------|
| VB-1 | 98120.203 | 0,58 |

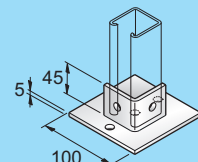

VB-1

Spanklauw Beam clamp

| Type | Artikel nr. Product no. | Gewicht Weight |
|------|----------------------------|-------------------|
| SK-A | 98548.203 | 0,10 |

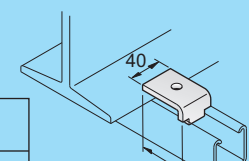

SK-A

Spanklauw Beam clamp

| Type | Artikel nr. Product no. | Gewicht Weight |
|------|----------------------------|-------------------|
| SK-B | 98546.203 | 0,11 |

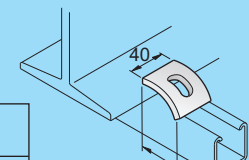

SK-B

Draagbalkklem Beam clamp

| L | Artikel nr. Product no. | Gewicht Weight |
|-------|----------------------------|-------------------|
| 21-41 | 98961.203 | 0,36 |
| 62-83 | 98963.203 | 0,40 |

