



Kabelkanalen - Cable ducts

blankstaal
thermisch verzinkt
gestraald gemenied

*plain steel
hot dip galvanized
blasted and primed*

C

Scheepsladder H30
Marine ladder H30

Gouda Holland



Kabelkanalen
Cable ducts

Scheepsladder H30

Marine ladder H30



kabelladder

blankstaal
thermisch verzinkt
gestraald gemenied

cable ladder

*plain steel
hot dip galvanized
blasted and primed*



Det Norske Veritas (DNV) en Germanischer Lloyd (GL)



Scheepsladder

H30

Kabelladder , Blankstaal
Kabelladder , Thermisch verzinkt
Kabelladder , Gestraald gemenied

Marine ladder

H30

Cable ladder, Plain steel
Cable ladder, Hot dip galvanized
Cable ladder, Blasted and primed

- chemisch resistent
 - blankstaal
 - thermisch verzinkt NEN-EN-ISO 1461
 - gestraald gemenied
 - standaardlengte 3000 mm
 - bodemprofiel eenzijdig gelast
 - bodemprofiel rondom gelast
 - zijwand met koppelplaten
 - zijwand zonder koppelplaten
- Op verzoek:
- afwijkende breedte- en lengtematen
 - hulpstukken $R \geq 100/150$ mm
 - afwijkende bodemprofielen
 - onbewerkt
 - op RALkleur gelakt

- chemically resistant
 - plain steel
 - hot dip galvanized NEN-EN-ISO 1461
 - blasted and primed
 - standard length 3000 mm
 - rung standard welded at one side
 - rung welded around
 - sidewall with coupling holes
 - sidewall without coupling holes
- On request:
- deviant width and length
 - fittings $R \geq 100/150$ mm
 - deviating rungs
 - not treated
 - RAL color coated

Scheepsladder H30 / Marine ladder H30

Met koppelgaten / With coupling holes

Bodemprofielen h.o.h. 250 mm
Rung distance c.t.c. 250 mm

- materiaaldikte zijwand 5 mm
- materiaaldikte bodemprofiel 4 mm
- hulpstukken $R = 100/150$
- material thickness sidewall 5 mm
- material thickness rung 4 mm
- fittings $R = 100/150$

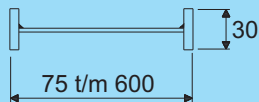

overspanning tot max. 3 meter
max. span: 3 mtr.

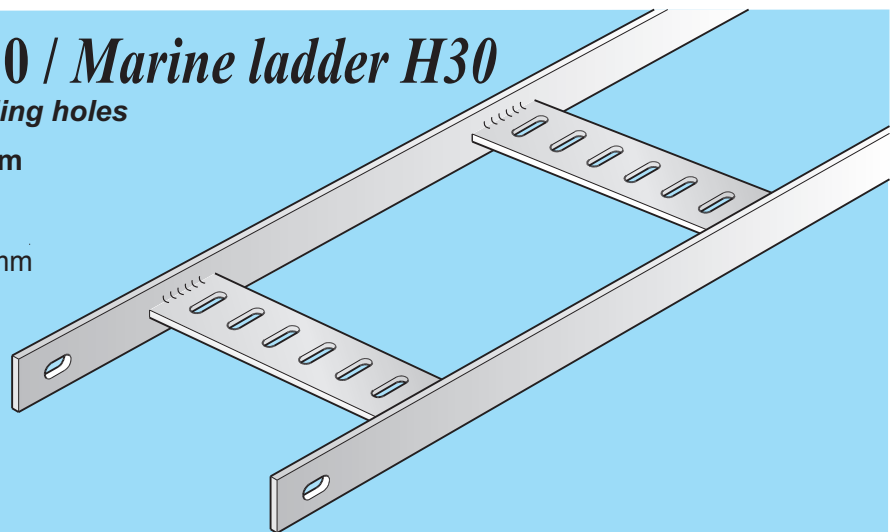

Kabelkanalen Scheepsladder

Cable ducts Marine ladder

Kabelladder , Blankstaal
Kabelladder , Thermisch verzinkt
Kabelladder , Gestraald gemenied

*Cable ladder, Plain steel
Cable ladder, Hot dip galvanized
Cable ladder, Blasted and primed*

C5-1 Algemeen

- Inhoudsopgave
- Technische gegevens
- Systemoverzicht

Pag.

C5-1-2
C5-1-3
C5-1-4

C5-1 General

- *Table of contents*
- *Technical specifications*
- *Survey of the system*

Page

C5-1-2
C5-1-3
C5-1-4

C5-2 Scheepsladder H30

- Kabelladders/Koppelplaten
- Hulpstukken

C5-2-1
C5-2-2/5

C5-2 Marine ladder H30

- *Cable ladders/Splice plates*
- *Fittings*

C5-2-1
C5-2-2/5

C5-3 Scheepsladder H30

- Kabelladders/Koppelplaten
- Hulpstukken

C5-3-1
C5-3-2/6

C5-3 Marine ladder H30

- *Cable ladders/Splice plates*
- *Fittings*

C5-3-1
C5-3-2/6

Technische gegevens

Technical specifications

Kenmerken

Features

Materiaal kwaliteit

De kabelladders, koppelplaten en hulpstukken, alsmede de ophang-inrichtingen worden verzinkt volgens NEN-EN-ISO 1461.

Systeem

Scheepsladder is een “medium duty” kabelladder systeem. Scheepsladder wordt geleverd in lengten van 3000 mm.

De ladderbodem is voorzien van geperforeerde bodemprofielen, aangebracht op een hartafstand van 250 mm.

De bodemprofielen en de zijwanden worden middels een lasconstructie aan elkaar bevestigd.

Hulpstukken

Hulpstukken worden geleverd met een standaard radius van 100/150 mm. Het systeem kan worden gecompleteerd met diverse plafond- en wandbevestigingen (zie hoofdstuk **E**).

Material Quality

The cable ladders, splice plates, fittings and suspension constructions are galvanized according to NEN-NE-ISO 1461.

System

Marine ladder is a “medium duty” cable ladder system. Marine ladder is supplied in lengths of 3000 mm.

The ladder bottom is provided with perforated bottom profiles placed on a centre distance of 250 mm.

The base section and side walls are connected through a welding construction.

Fittings

*Fittings are supplied with a standard radius of 100/150 mm. The system can be completed with several ceiling- and wall-attachments (see chapter **E**).*

Scheepsladder H30 met koppelgaten
Marine ladder H30 with coupling holes

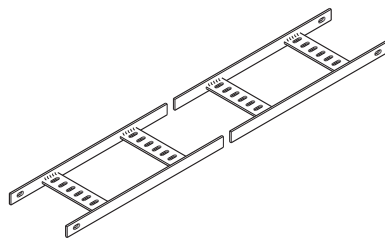

Koppelplaat - set
Splice plate - set

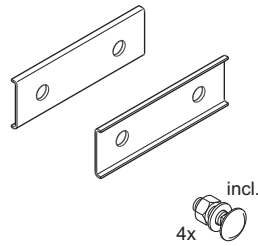

Scharn. koppelplaat-set
Hinged splice plate - set

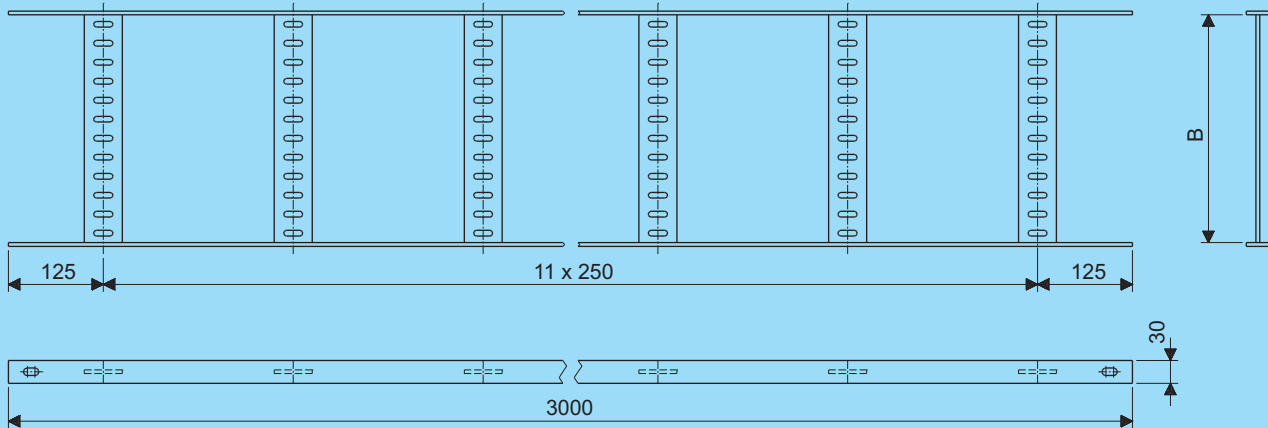
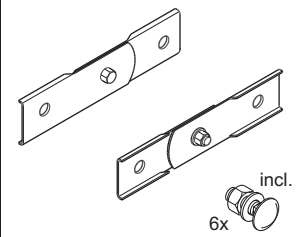

bestel de benodigde koppelplaten apart, zij worden niet geleverd bij de kanalen
order splice plates as separate items, they are not supplied with the cable ducts

Scheepsladder H30 met koppelgaten Marine ladder H30 with coupling holes							
Blankstaal Plain steel			Thermisch verzinkt Hot dip galvanized				
Enkel gelast Single welded		Rondom gelast Welded around	Enkel gelast Single welded		Rondom gelast Welded around		
B	Artikel nr. Product no.	Gewicht Weight	B	Artikel nr. Product no.	Gewicht Weight		
75	26000.230	26020.230	8,42	75	26000.233	26020.233	9,18
100	26001.230	26021.230	8,83	100	26001.233	26021.233	9,62
150	26002.230	26022.230	9,69	150	26002.233	26022.233	10,57
200	26003.230	26023.230	10,41	200	26003.233	26023.233	11,35
250	26004.230	26024.230	11,35	250	26004.233	26024.233	12,37
300	26005.230	26025.230	12,19	300	26005.233	26025.233	13,29
400	26006.230	26026.230	13,53	400	26006.233	26026.233	14,75
500	26007.230	26027.230	15,12	500	26007.233	26027.233	16,48
600	26008.230	26028.230	16,84	600	26008.233	26028.233	18,36

Scheepsladder

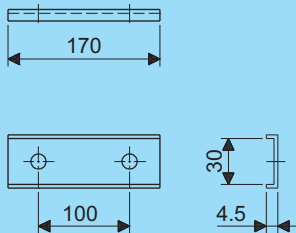

levering inclusief:
4 slotbouten M10 x 20,
moeren en sluitringen
supplied complete with:
4 lock screws M10 x 20,
nuts and washers

Koppelplaat - set Splice plate - set		
Blankstaal Plain steel		Thermisch verzinkt Hot dip galvanized
Artikel nr. Product no.	Gewicht Weight	
26500.200	26500.203	0,39

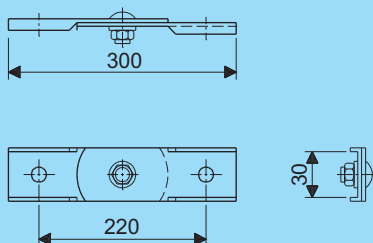

levering inclusief:
6 slotbouten M10 x 20,
moeren en sluitringen
supplied complete with:
6 lock screws M10 x 20,
nuts and washers

Scharn. koppelplaat - set Hinged splice plate - set		
Blankstaal Plain steel		Thermisch verzinkt Hot dip galvanized
Artikel nr. Product no.	Gewicht Weight	
26510.200	26510.203	0,72

Scheepsladder

Marine ladder

H30

Horizontaal bochtstuk 90° met koppelgaten
Horizontal bend 90° with coupling holes

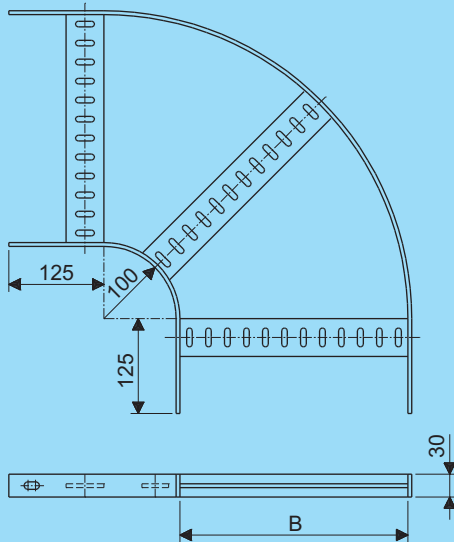
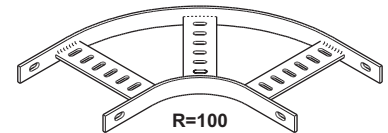

Horizontaal bochtstuk 90° met koppelgaten
Horizontal bend 90° with coupling holes

Blankstaal
Plain steel

Thermisch verzinkt
Hot dip galvanized

Enkel gelast
Single welded

Rondom gelast
Welded around

Enkel gelast
Single welded

Rondom gelast
Welded around

B	Artikel nr. Product no.	Gewicht Weight	B	Artikel nr. Product no.	Gewicht Weight		
75	26100.230	26120.230	1,43	75	26100.233	26120.233	1,56
100	26101.230	26121.230	1,58	100	26101.233	26121.233	1,72
150	26102.230	26122.230	1,89	150	26102.233	26122.233	2,06
200	26103.230	26123.230	2,16	200	26103.233	26123.233	2,36
250	26104.230	26124.230	2,49	250	26104.233	26124.233	2,72
300	26105.230	26125.230	2,80	300	26105.233	26125.233	3,05
400	26106.230	26126.230	3,85	400	26106.233	26126.233	4,20
500	26107.230	26127.230	4,56	500	26107.233	26127.233	4,98
600	26108.230	26128.230	5,33	600	26108.233	26128.233	5,81

bestel de benodigde
koppelplaten apart
order splice plates as
separate items

Scheepsladder

Marine ladder

H30

Aftakstuk met koppelgaten
Brench with coupling holes

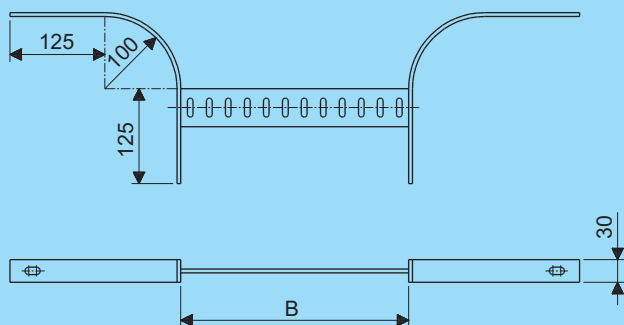
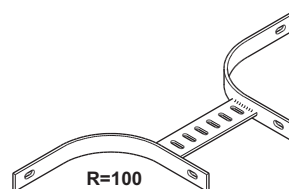

Aftakstuk met koppelgaten Brench with coupling holes							
Blankstaal Plain steel				Thermisch verzinkt Hot dip galvanized			
Enkel gelast Single welded		Rondom gelast Welded around		Enkel gelast Single welded		Rondom gelast Welded around	
B	Artikel nr. Product no.	Gewicht Weight		B	Artikel nr. Product no.	Gewicht Weight	
75	26200.230	26220.230	1,08	75	26200.233	26220.233	1,17
100	26201.230	26221.230	1,11	100	26201.233	26221.233	1,21
150	26202.230	26222.230	1,18	150	26202.233	26222.233	1,29
200	26203.230	26223.230	1,24	200	26203.233	26223.233	1,35
250	26204.230	26224.230	1,32	250	26204.233	26224.233	1,44
300	26205.230	26225.230	1,39	300	26205.233	26225.233	1,52
400	26206.230	26226.230	1,50	400	26206.233	26226.233	1,64
500	26207.230	26227.230	1,63	500	26207.233	26227.233	1,78
600	26208.230	26228.230	1,79	600	26208.233	26228.233	1,94

bestel de benodigde
koppelplaten apart
order splice plates as
separate items

Scheepsladder

Marine ladder

H30

Driewegstuk met koppelgaten
Equal tee piece with coupling holes

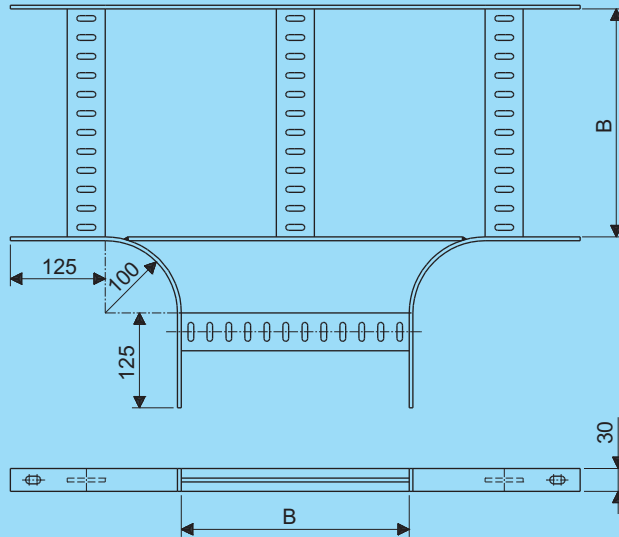
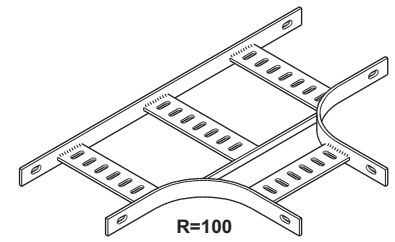

Driewegstuk met koppelgaten Equal tee piece with coupling holes							
Blankstaal Plain steel				Thermisch verzinkt Hot dip galvanized			
Enkel gelast Single welded		Rondom gelast Welded around		Enkel gelast Single welded		Rondom gelast Welded around	
B	Artikel nr. Product no.	Gewicht Weight		B	Artikel nr. Product no.	Gewicht Weight	
75	26300.230	26320.230	2,21	75	26300.233	26320.233	2,41
100	26301.230	26321.230	2,39	100	26301.233	26321.233	2,61
150	26302.230	26322.230	2,78	150	26302.233	26322.233	3,03
200	26303.230	26323.230	3,12	200	26303.233	26323.233	3,40
250	26304.230	26324.230	3,53	250	26304.233	26324.233	3,85
300	26305.230	26325.230	3,91	300	26305.233	26325.233	4,26
400	26306.230	26326.230	5,08	400	26306.233	26326.233	5,54
500	26307.230	26327.230	5,94	500	26307.233	26327.233	6,48
600	26308.230	26328.230	6,86	600	26308.233	26328.233	7,48

bestel de benodigde
koppelplaten apart
order splice plates as
separate items

Scheepsladder

Marine ladder

H30

Stijg-vervalstuk 90° met koppelgaten
Inner-outer bend 90° with coupling holes

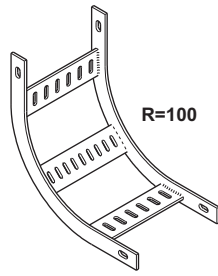

Bevestigingsbeugel
Hold down clip

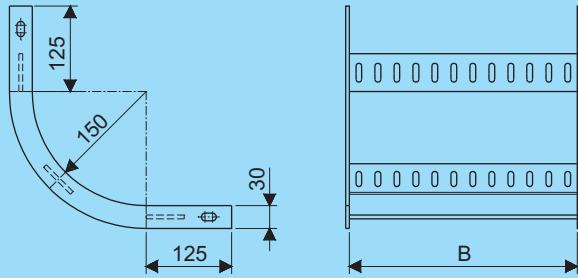
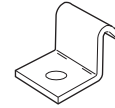

Stijg-vervalstuk 90° met koppelgaten <i>Inner-outer bend 90° with coupling holes</i>							
Blankstaal <i>Plain steel</i>			Thermisch verzinkt <i>Hot dip galvanized</i>				
Enkel gelast <i>Single welded</i>		Rondom gelast <i>Welded around</i>	Enkel gelast <i>Single welded</i>		Rondom gelast <i>Welded around</i>		
B	Artikel nr. <i>Product no.</i>	Gewicht <i>Weight</i>	B	Artikel nr. <i>Product no.</i>	Gewicht <i>Weight</i>		
75	26400.230	26420.230	1,46	75	26400.233	26420.233	1,59
100	26401.230	26421.230	1,56	100	26401.233	26421.233	1,70
150	26402.230	26422.230	1,78	150	26402.233	26422.233	1,94
200	26403.230	26423.230	1,96	200	26403.233	26423.233	2,13
250	26404.230	26424.230	2,19	250	26404.233	26424.233	2,39
300	26405.230	26425.230	2,40	300	26405.233	26425.233	2,62
400	26406.230	26426.230	2,74	400	26406.233	26426.233	2,98
500	26407.230	26427.230	3,13	500	26407.233	26427.233	3,42
600	26408.230	26428.230	3,57	600	26408.233	26428.233	3,89

bestel de benodigde
koppelplaten apart
*order splice plates as
separate items*

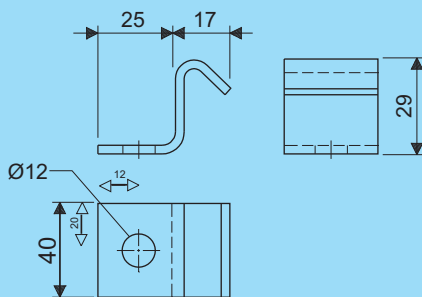

Bevestigingsbeugel <i>Hold down clip</i>	
Artikel nr. <i>Product no.</i>	Gewicht <i>Weight</i>
98671.203	2,34

Scheepsladder

H30

Kabelladder , Blankstaal
Kabelladder , Gestraald gemenied

Marine ladder

H30

Cable ladder, Plain steel
Cable ladder, Blasted and primed

- chemisch resistent
 - blankstaal
 - gestraald gemenied
 - standaardlengte 3000 mm
 - bodemprofiel eenzijdig gelast
 - bodemprofiel rondom gelast
 - zijwand zonder koppelplaten
- Op verzoek:
- afwijkende breedte- en lengtematen
 - hulpstukken $R \geq 100/150$ mm
 - afwijkende bodemprofielen

- *chemically resistant*
 - *plain steel*
 - *blasted and primed*
 - *standard length 3000 mm*
 - *rung standard welded at one side*
 - *rung welded around*
 - *sidewall without coupling holes*
- On request:
- *deviant width and length*
 - *fittings $R \geq 100/150$ mm*
 - *deviating rungs*

Scheepsladder H30 / Marine ladder H30

Zonder koppelgaten / Without coupling holes

Bodemprofielen h.o.h. 250 mm
Rung distance c.t.c. 250 mm

- materiaaldikte zijwand 5 mm
- materiaaldikte bodemprofiel 4 mm
- hulpstukken $R = 100/150$
- *material thickness sidewall 5 mm*
- *material thickness rung 4 mm*
- *fittings $R = 100/150$*

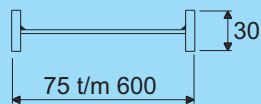

overspanning tot max. 3 meter
max. span: 3 mtr.

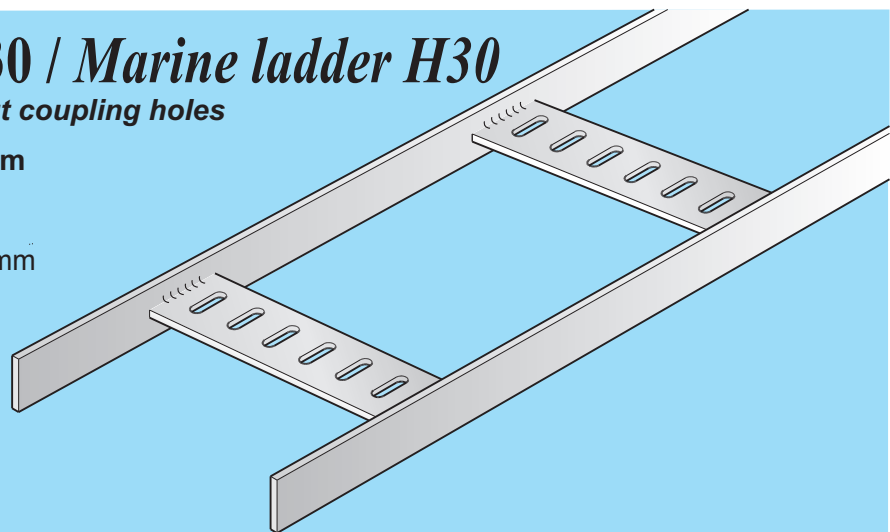

Scheepsladder H30 zonder koppelgaten
 Marine ladder H30 without coupling holes

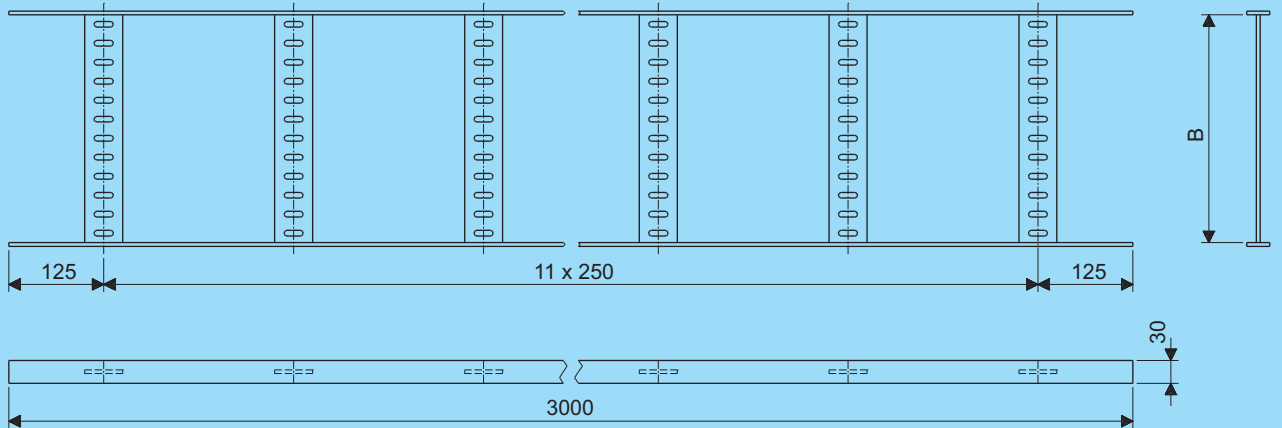
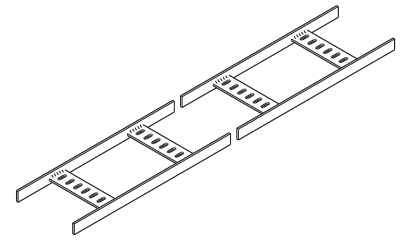

Scheepsladder H30 zonder koppelgaten Marine ladder H30 without coupling holes							
Blankstaal Plain steel			Blankstaal, gestraald gemenied Plain steel, blasted and primer				
Enkel gelast Single welded		Rondom gelast Welded around	Enkel gelast Single welded		Rondom gelast Welded around		
B	Artikel nr. Product no.	Gewicht Weight	B	Artikel nr. Product no.	Gewicht Weight		
75	26010.230	26030.230	8,42	75	26010.239	26030.239	8,71
100	26011.230	26031.230	8,83	100	26011.239	26031.239	9,14
150	26012.230	26032.230	9,69	150	26012.239	26032.239	10,03
200	26013.230	26033.230	10,41	200	26013.239	26033.239	10,78
250	26014.230	26034.230	11,35	250	26014.239	26034.239	11,74
300	26015.230	26035.230	12,19	300	26015.239	26035.239	12,62
400	26016.230	26036.230	13,53	400	26016.239	26036.239	14,01
500	26017.230	26037.230	15,12	500	26017.239	26037.239	15,65
600	26018.230	26038.230	16,84	600	26018.239	26038.239	17,84

Scheepsladder

Marine ladder

H30

Horizontaal bochtstuk 90° zonder koppelgaten
Horizontal bend 90° without coupling holes

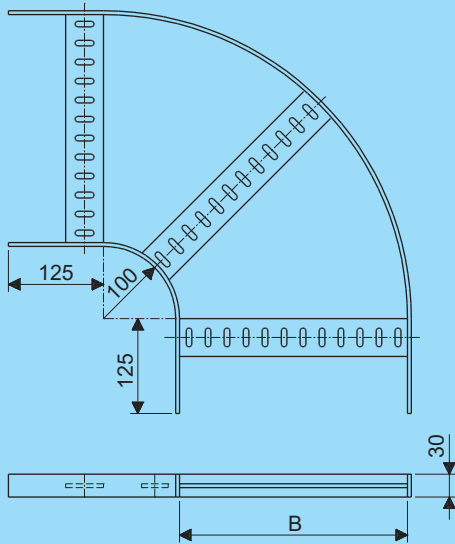
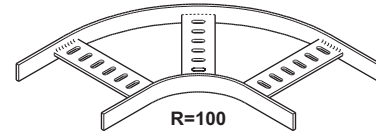

Horizontaal bochtstuk 90° zonder koppelgaten Horizontal bend 90° without coupling holes							
Blankstaal Plain steel				Blankstaal, gestraald gemenied Plain steel, blasted and primer			
Enkel gelast Single welded		Rondom gelast Welded around		Enkel gelast Single welded		Rondom gelast Welded around	
B	Artikel nr. Product no.	Gewicht Weight		B	Artikel nr. Product no.	Gewicht Weight	
75	26110.230	26130.230	1,43	75	26110.239	26130.239	1,48
100	26111.230	26131.230	1,58	100	26111.239	26131.239	1,63
150	26112.230	26132.230	1,89	150	26112.239	26132.239	1,96
200	26113.230	26133.230	2,16	200	26113.239	26133.239	2,24
250	26114.230	26134.230	2,49	250	26114.239	26134.239	2,58
300	26115.230	26135.230	2,80	300	26115.239	26135.239	2,90
400	26116.230	26136.230	3,85	400	26116.239	26136.239	3,99
500	26117.230	26137.230	4,56	500	26117.239	26137.239	4,73
600	26118.230	26138.230	5,33	600	26118.239	26138.239	5,52

Scheepsladder

Marine ladder

H30

Aftakstuk zonder koppelgaten
Brench without coupling holes

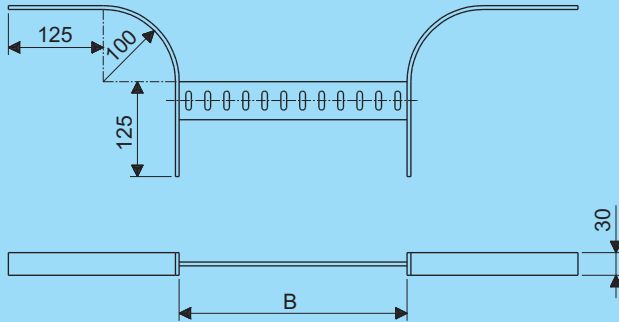
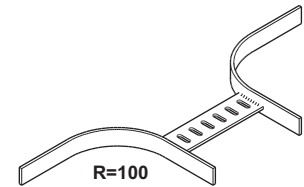

Aftakstuk zonder koppelgaten Brench without coupling holes							
Blankstaal Plain steel				Blankstaal, gestraald gemenied Plain steel, blasted and primer			
Enkel gelast Single welded		Rondom gelast Welded around		Enkel gelast Single welded		Rondom gelast Welded around	
B	Artikel nr. Product no.	Gewicht Weight		B	Artikel nr. Product no.	Gewicht Weight	
75	26210.230	26230.230	1,08	75	26210.239	26230.239	1,11
100	26211.230	26231.230	1,11	100	26211.239	26231.239	1,15
150	26212.230	26232.230	1,18	150	26212.239	26232.239	1,22
200	26213.230	26233.230	1,24	200	26213.239	26233.239	1,29
250	26214.230	26234.230	1,32	250	26214.239	26234.239	1,37
300	26215.230	26235.230	1,39	300	26215.239	26235.239	1,44
400	26216.230	26236.230	1,50	400	26216.239	26236.239	1,55
500	26217.230	26237.230	1,63	500	26217.239	26237.239	1,69
600	26218.230	26238.230	1,79	600	26218.239	26238.239	1,84

Scheepsladder

Marine ladder

H30

Driewegstuk zonder koppelgaten
Equal tee piece without coupling holes

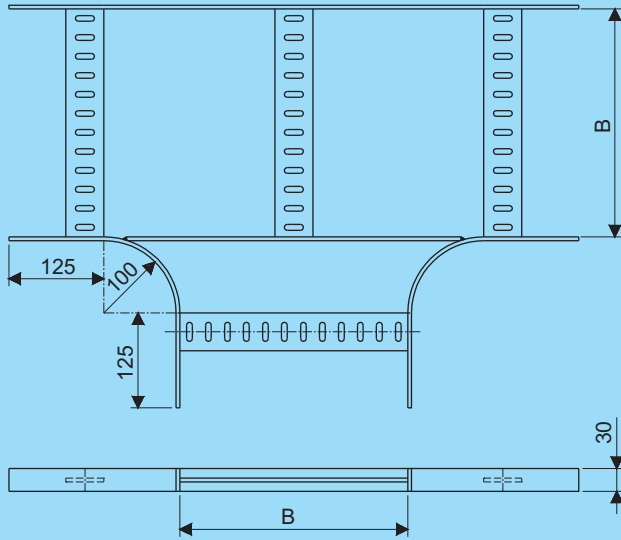
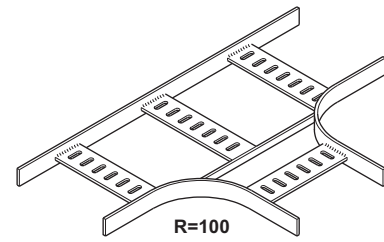

Driewegstuk zonder koppelgaten Equal tee piece without coupling holes							
Blankstaal Plain steel				Blankstaal, gestraald gemenied Plain steel, blasted and primer			
Enkel gelast Single welded		Rondom gelast Welded around		Enkel gelast Single welded		Rondom gelast Welded around	
B	Artikel nr. Product no.	Gewicht Weight		B	Artikel nr. Product no.	Gewicht Weight	
75	26310.230	26330.230	2,21	75	26310.239	26330.239	2,29
100	26311.230	26331.230	2,39	100	26311.239	26331.239	2,48
150	26312.230	26332.230	2,78	150	26312.239	26332.239	2,88
200	26313.230	26333.230	3,12	200	26313.239	26333.239	3,24
250	26314.230	26334.230	3,53	250	26314.239	26334.239	3,66
300	26315.230	26335.230	3,91	300	26315.239	26335.239	4,05
400	26316.230	26336.230	5,08	400	26316.239	26336.239	5,26
500	26317.230	26337.230	5,94	500	26317.239	26337.239	6,15
600	26318.230	26338.230	6,86	600	26318.239	26338.239	7,10

Scheepsladder

Marine ladder

H30

Stijg-vervalstuk 90° zonder koppelgaten
Inner-outer bend 90° without coupling holes

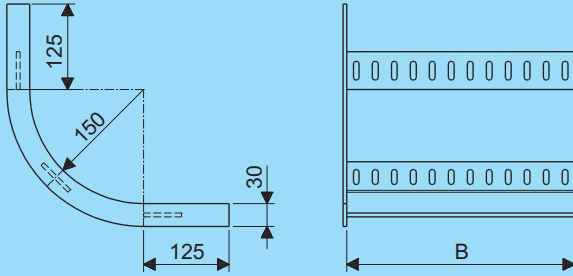
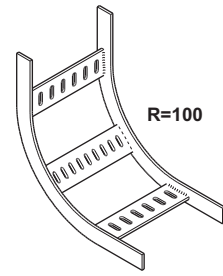

Stijg-vervalstuk 90° zonder koppelgaten <i>Inner-outer bend 90° without coupling holes</i>							
Blankstaal <i>Plain steel</i>			Blankstaal, gestraald gemenied <i>Plain steel, blasted and primer</i>				
Enkel gelast <i>Single welded</i>		Rondom gelast <i>Welded around</i>	Enkel gelast <i>Single welded</i>		Rondom gelast <i>Welded around</i>		
B	Artikel nr. <i>Product no.</i>		Gewicht <i>Weight</i>	B	Artikel nr. <i>Product no.</i>		Gewicht <i>Weight</i>
75	26410.230	26430.230	1,46	75	26410.239	26430.239	1,51
100	26411.230	26431.230	1,56	100	26411.239	26431.239	1,62
150	26412.230	26432.230	1,78	150	26412.239	26432.239	1,84
200	26413.230	26433.230	1,96	200	26413.239	26433.239	2,03
250	26414.230	26434.230	2,19	250	26414.239	26434.239	2,27
300	26415.230	26435.230	2,40	300	26415.239	26435.239	2,49
400	26416.230	26436.230	2,74	400	26416.239	26436.239	2,83
500	26417.230	26437.230	3,13	500	26417.239	26437.239	3,24
600	26418.230	26438.230	3,57	600	26418.239	26438.239	3,69



GoudaHolland B.V.

Grote Esch 80
2841 MJ Moordrecht
The Netherlands

P.O. Box 200
2800 AE Gouda
The Netherlands

tel. +31 (0) 182-506200

www.goudaholland.nl
info@goudaholland.nl



GoudaHolland

