

STRUT

STRUT MONTAGE SYSTEM

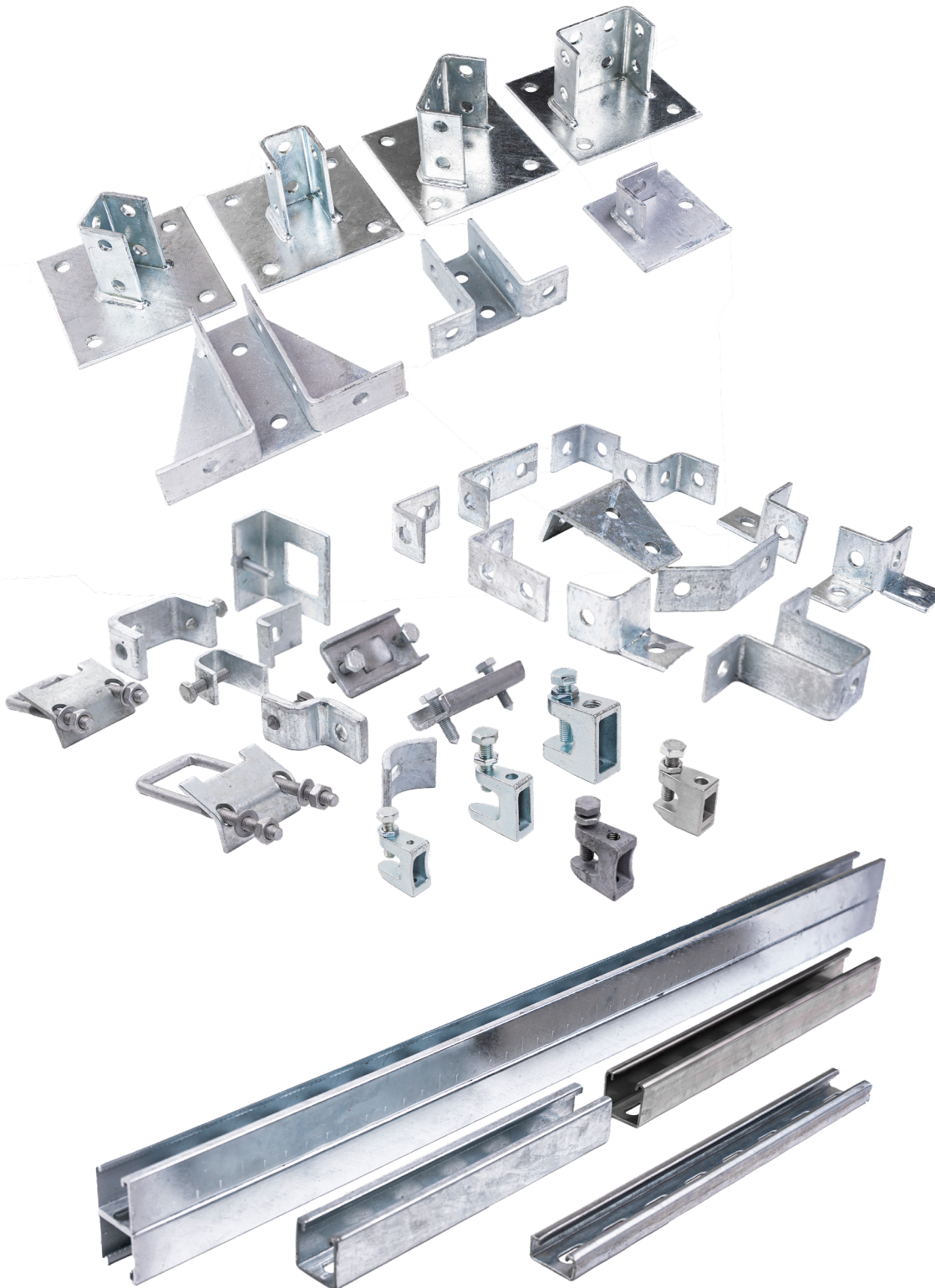

Index

Staal

- E** Staal, elektrolytisch verzinkt
- S** Staal, sendzimir verzinkt volgens EN 10327
- ZM** Zink Magnesium ZM310
- V** Staal, volbad thermisch verzinkt volgens EN ISO 1461



Roestvast staal

- R2** Roestvast staal 304/A2
- R4** Roestvast staal 316/A4

Kunststof

- K** Kunststof



Aanvullende productinformatie

In deze PDF kunt u door op artikelnummers klikken, het betreffende product bekijken in ons **online productenportaal**. Daar vindt u aanvullende informatie en technische specificaties.

Via onderstaande knop opent u het volledige productenportaal.

Niedax Kleinhuis B.V.
Bijsterhuizen 20-05A
6604 LH Wijchen

Tel.: +31 (0) 24 378 85 33

info@niedax.nl
www.niedax.nl



Inhoud

Fig.	Producten	Paginnummer
NX0 - Railprofielen		
1	NX0010 Railprofiel	NX4 - NX6
2	NX0020 Railprofiel, geperforeerd	NX4
3	NX0030 Railprofiel, geperforeerd	NX4
4	NX0040 Railprofiel	NX4
5	NX0050 / NX0060 Railprofiel, geperforeerd	NX5
6	NX0070 Railprofiel, geperforeerd	NX5
7	NX0080 Railprofiel	NX5
8	NX0090 / NX0100 Railprofiel, geperforeerd	NX5
9	NX0110 Railprofiel, geperforeerd	NX6
NX1 - Vlakke platen		
10	NX1040 Vlakke plaat	NX7 - NX8
NX2 - Montagehoeken		
11	NX2050 Montagehoek	NX9 - NX11
12	NX2150 Montagehoek 135°	NX9
NX3 - U en Z beugels		
13	NX3010 Z - beugel	NX13 - NX14
14	NX3020 Z - beugel	NX13
NX4 - Koppelstukken		
15	NX4010 Koppelstuk extern	NX15
16	NX4030 Koppelstuk intern	NX15
NX5 - Voetplaten en vleugelstukken		
17	NX5010 Voetplaat	NX17 - NX18
18	NX5030 Vleugelstuk	NX17
NX6 - Balkklemmen		
NX7 - Glijmoeren en hamerkopbouten		
19	NX7110 Glijmoer met lange veer	NX23 - NX24
NX8 - Eindkappen en deksels		
20	NX8020K Eindkap, inwendig	NX25
NX9 - Consoles		
NX27 - NX28		
Bevestigingsmateriaal		
NX29 - NX32		

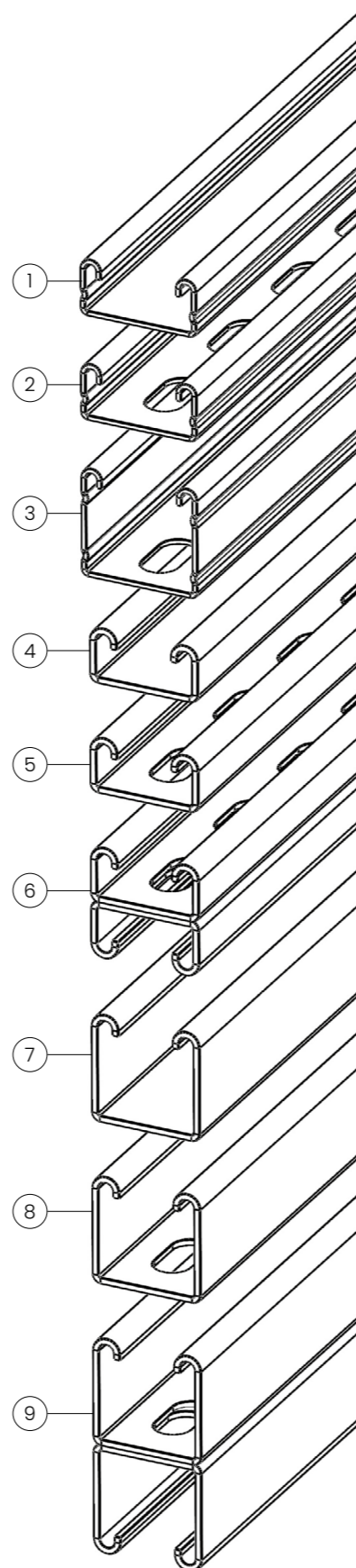

Overzicht railprofielen

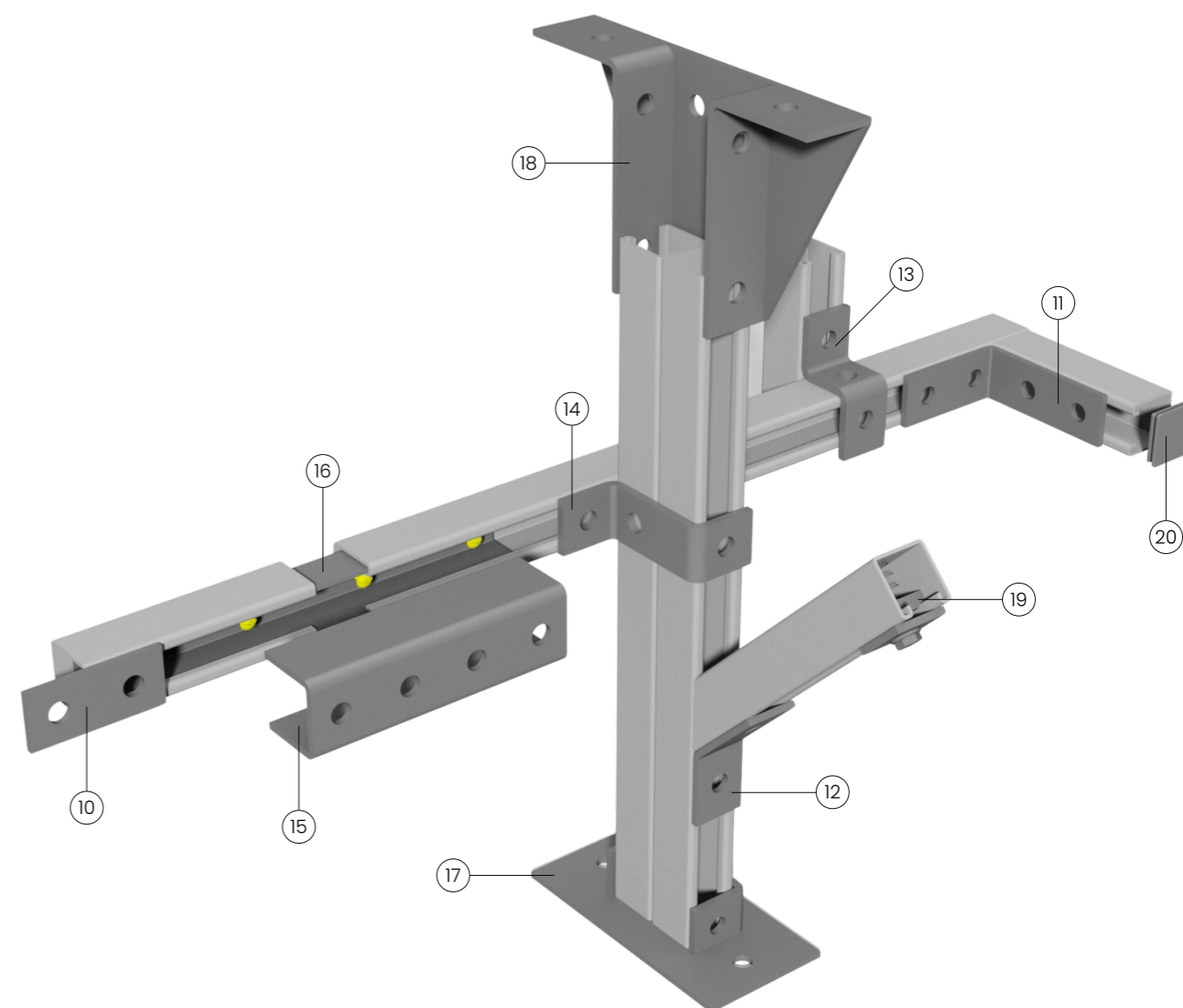

Overzicht Strut onderdelen

NX0 - Railprofielen

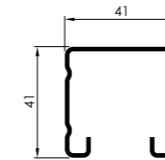
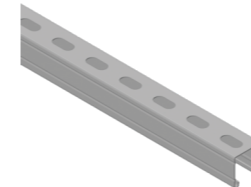
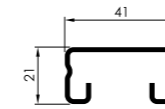
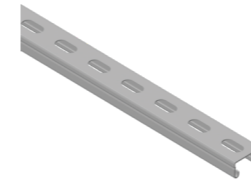
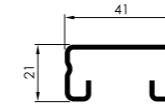
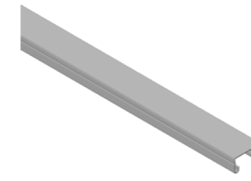

Typenummer	BxH mm	Artikel nummer	Materiaal dikte mm	kg m	VPE	Kortings groep
------------	--------	----------------	--------------------	------	-----	----------------

Railprofiel						
S NX0010S	41x21	82000	1,5	1,21	6 m	HA

Railprofiel, geperforeerd						
S NX0020S	41x21	82001	1,5	1,05	6 m	HA

Railprofiel, geperforeerd						
S NX0030S	41x41	82003	1,5	1,48	6 m	HA

NX0 - Railprofielen

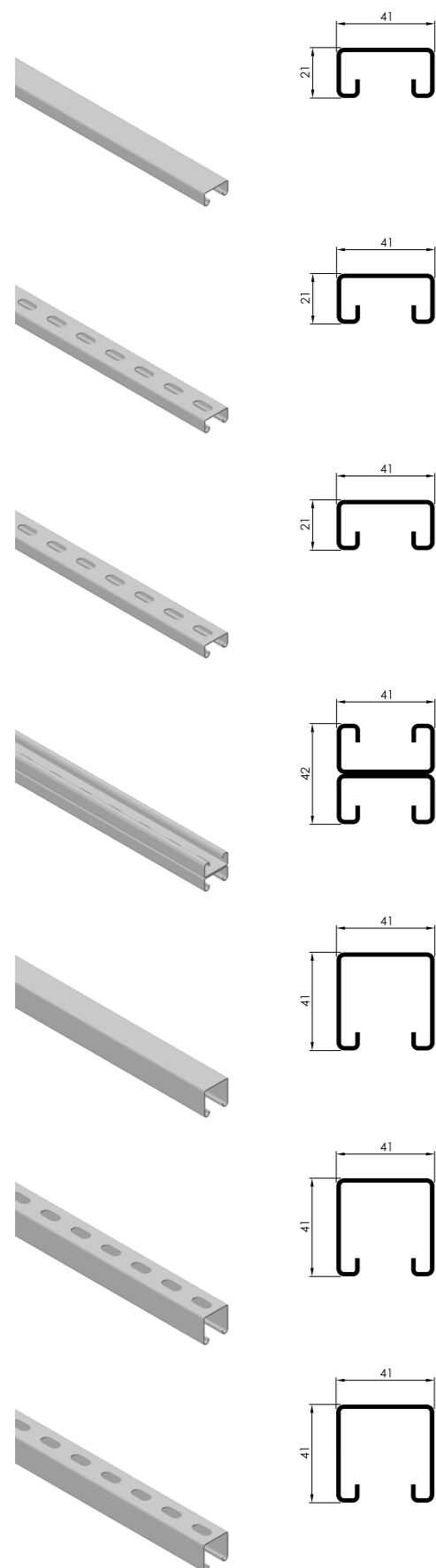

Typenummer	BxH mm	Artikel nummer	Materiaal dikte mm	kg m	VPE	Kortings groep
Railprofiel						
S NX0040S	41x21	82004	2,5	1,72	6 m	HA
V NX0040V	41x21	82104	2,5	1,90	6 m	HA
R4 NX0040R4	41x21	83104	2,5	1,72	6 m	HA
Railprofiel, geperforeerd						
S NX0050S	41x21	82005	2,5	1,63	6 m	HA
ZM NX0050ZM	41x21	82125	2,5	1,63	6 m	HA
V NX0050V	41x21	82105	2,5	1,76	6 m	HA
R2 NX0050R2	41x21	83005	2,5	1,63	6 m	HA
R4 NX0050R4	41x21	83105	2,5	1,63	6 m	HA
Railprofiel, geperforeerd						
S NX0060S	41x21	82055	2,5	1,63	3 m	HA
V NX0060V	41x21	82155	2,5	1,76	3 m	HA
R2 NX0060R2	41x21	83055	2,5	1,63	3 m	HA
R4 NX0060R4	41x21	83155	2,5	1,63	3 m	HA
Railprofiel, geperforeerd						
S NX0070S	41x42	82006	2,5	3,40	6 m	HA
V NX0070V	41x42	82106	2,5	3,53	6 m	HA
R4 NX0070R4	41x42	83106	2,5	3,40	6 m	HA
Railprofiel						
S NX0080S	41x41	82007	2,5	2,68	6 m	HA
V NX0080V	41x41	82107	2,5	2,88	6 m	HA
R4 NX0080R4	41x41	83107	2,5	2,68	6 m	HA
Railprofiel, geperforeerd						
S NX0090S	41x41	82008	2,5	2,55	6 m	HA
ZM NX0090ZM	41x41	82128	2,5	2,55	6 m	HA
V NX0090V	41x41	82108	2,5	2,68	6 m	HA
R2 NX0090R2	41x41	83008	2,5	2,55	6 m	HA
R4 NX0090R4	41x41	83108	2,5	2,55	6 m	HA
Railprofiel, geperforeerd						
S NX0100S	41x41	82058	2,5	2,55	3 m	HA
V NX0100V	41x41	82158	2,5	2,68	3 m	HA
R2 NX0100R2	41x41	83058	2,5	2,55	3 m	HA
R4 NX0100R4	41x41	83158	2,5	2,55	3 m	HA

NX0 - Railprofielen

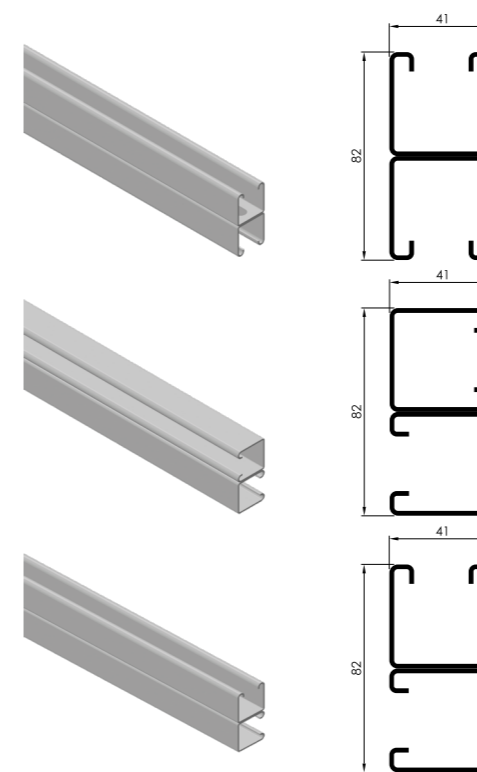

Typenummer	BxH mm	Artikel nummer	Materiaal dikte mm	kg m	VPE	Kortings groep
Railprofiel, geperforeerd						
S NX0110S	41x82	82009	2,5	5,20	6 m	HA
V NX0110V	41x82	82109	2,5	5,43	6 m	HA
R4 NX0110R4	41x82	83109	2,5	5,20	6 m	HA
Railprofiel						
V NX0120V	41x82	82110	2,5	5,70	6 m	HA
Railprofiel						
V NX0130V	41x82	82111	2,5	5,70	6 m	HA

NX1 - Vlakke platen

Typenummer	Gatmaat ø mm	Artikel nummer	Materiaal dikte mm	kg stuk	VPE	Kortings groep
------------	-----------------	-------------------	--------------------------	------------	-----	-------------------

Vlakke plaat

V	NX1000V	8	82200	5	0,07	100 st.	HA
	NX1010V	10	82201	5	0,07	100 st.	HA
	NX1020V	12	82202	5	0,07	100 st.	HA
	NX1030V	14	82203	5	0,07	100 st.	HA
R4	NX1000R4	8	83200	5	0,06	100 st.	HA
	NX1010R4	10	83201	5	0,06	100 st.	HA
	NX1020R4	12	83202	5	0,06	100 st.	HA
	NX1030R4	14	83203	5	0,06	100 st.	HA

Vlakke plaat

V	NX1040V	14	82204	5	0,15	25 st.	HA
R4	NX1040R4	14	83204	5	0,13	25 st.	HA

Vlakke plaat

V	NX1050V	14	82205	5	0,23	25 st.	HA
R4	NX1050R4	14	83205	5	0,20	25 st.	HA

Vlakke plaat

V	NX1060V	14	82206	5	0,30	25 st.	HA
R4	NX1060R4	14	83206	5	0,27	25 st.	HA

Vlakke plaat

V	NX1070V	14	82207	5	0,36	25 st.	HA
R4	NX1070R4	14	83207	5	0,34	25 st.	HA

Vlakke plaat

V	NX1080V	14	82208	5	0,22	25 st.	HA
R4	NX1080R4	14	83208	5	0,20	25 st.	HA

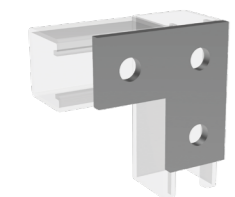
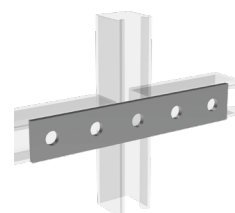
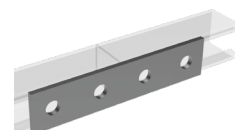
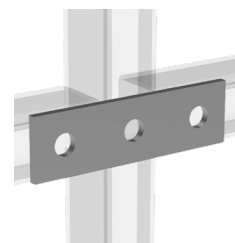
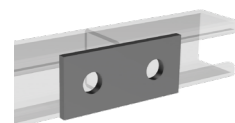
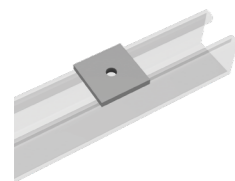

NX1 - Vlakke platen

Typenummer	Gatmaat ø mm	Artikel nummer	Materiaal dikte mm	kg stuk	VPE	Kortings groep
------------	-----------------	-------------------	--------------------------	------------	-----	-------------------

Vlakke plaat

V	NX1090V	14	82209	5	0,30	20 st.	HA
R4	NX1090R4	14	83209	5	0,27	20 st.	HA

Vlakke plaat

V	NX1100V	14	82210	5	0,42	20 st.	HA
R4	NX1100R4	14	83210	5	0,36	20 st.	HA

Vlakke plaat

V	NX1110V	14	82211	5	0,42	15 st.	HA
R4	NX1110R4	14	83211	5	0,36	15 st.	HA

Vlakke plaat

V	NX1120V	14	82212	5	0,44	25 st.	HA
R4	NX1120R4	14	83212	5	0,36	25 st.	HA

Vlakke plaat

V	NX1130V	14	82213	5	0,39	20 st.	HA
R4	NX1130R4	14	83213	5	0,37	20 st.	HA

Vlakke plaat

V	NX1140V	14	82214	5	0,28	25 st.	HA
R4	NX1140R4	14	83214	5	0,26	25 st.	HA

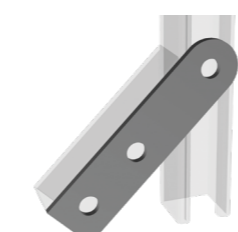
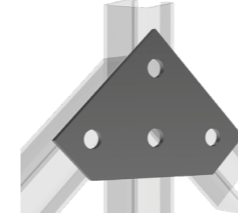
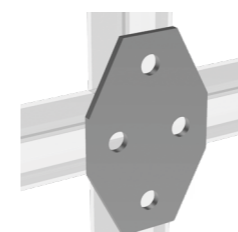
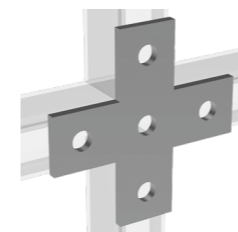
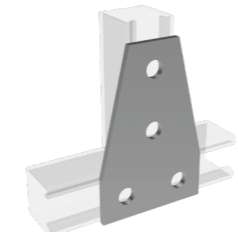
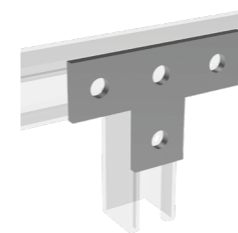

NX2 - Montagehoeken

Typenummer	Gatmaat ø mm	Artikel nummer	Materiaal dikte mm	kg stuk	VPE	Kortings groep
------------	-----------------	-------------------	--------------------------	------------	-----	-------------------

Montagehoek

V NX2000V	14	82220	5	0,15	50 st.	HA
R4 NX2000R4	14	83220	5	0,13	50 st.	HA

Montagehoek

V NX2010V	14	82221	5	0,15	50 st.	HA
R4 NX2010R4	14	83221	5	0,13	50 st.	HA

Montagehoek

V NX2020V	14	82222	5	0,22	25 st.	HA
R4 NX2020R4	14	83222	5	0,20	25 st.	HA

Montagehoek

V NX2030V	14	82223	5	0,22	25 st.	HA
R4 NX2030R4	14	83223	5	0,20	25 st.	HA

Montagehoek

V NX2040V	14	82224	5	0,22	25 st.	HA
R4 NX2040R4	14	83224	5	0,20	25 st.	HA

Montagehoek

V NX2045V	14	82237	5	0,28	25 st.	HA
R4 NX2045R4	14	83237	5	0,26	25 st.	HA

Montagehoek

V NX2050V	14	82225	5	0,31	25 st.	HA
R4 NX2050R4	14	83225	5	0,27	25 st.	HA

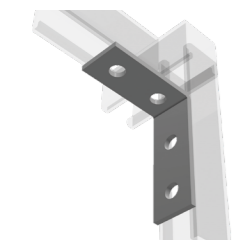
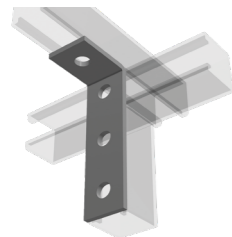
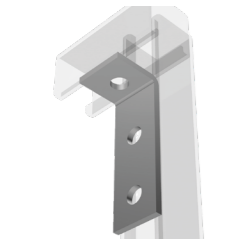
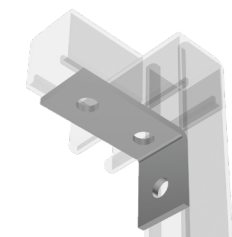
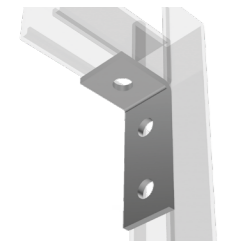
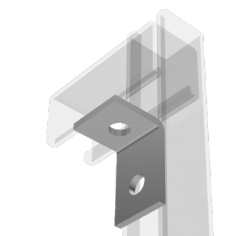
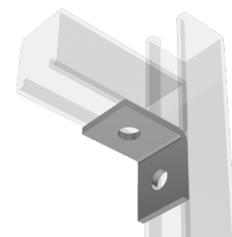

NX2 - Montagehoeken

Typenummer	Gatmaat ø mm	Artikel nummer	Materiaal dikte mm	kg stuk	VPE	Kortings groep
------------	-----------------	-------------------	--------------------------	------------	-----	-------------------

Montagehoek

V NX2060V	14	82226	5	0,46	10 st.	HA
R4 NX2060R4	14	83226	5	0,44	10 st.	HA

Montagehoek

V NX2070V	14	82227	5	0,32	25 st.	HA
R4 NX2070R4	14	83227	5	0,30	25 st.	HA

Montagehoek

V NX2080V	14	82228	5	0,45	20 st.	HA
R4 NX2080R4	14	83228	5	0,36	20 st.	HA

Montagehoek

V NX2090V	14	82229	5	0,29	20 st.	HA
R4 NX2090R4	14	83229	5	0,27	20 st.	HA

Montagehoek

V NX2095V	14	82238	5	0,51	20 st.	HA
R4 NX2095R4	14	83238	5	0,44	20 st.	HA

Montagehoek

V NX2100V	14	82230	5	0,30	25 st.	HA
R4 NX2100R4	14	83230	5	0,27	25 st.	HA

Montagehoek

V NX2110V	14	82231	5	0,30	25 st.	HA
R4 NX2110R4	14	83231	5	0,27	25 st.	HA

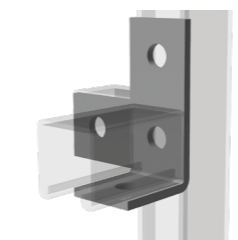
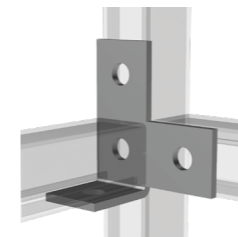
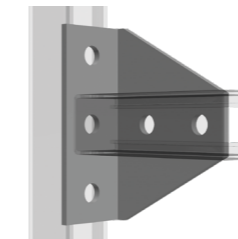
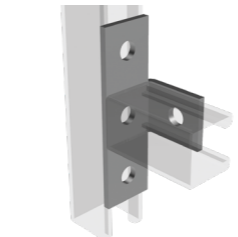
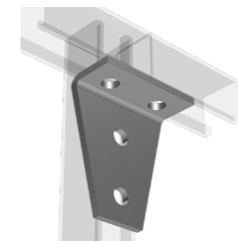
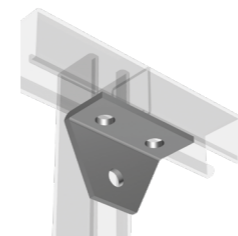
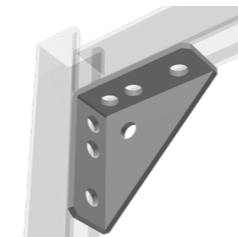

NX2 - Montagehoeken

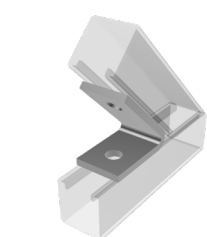
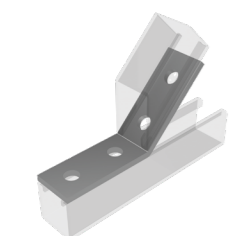
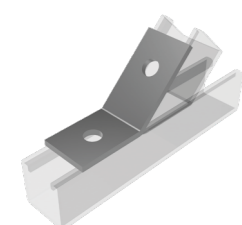
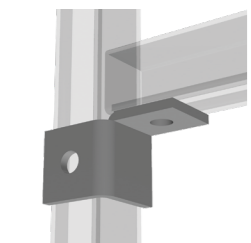
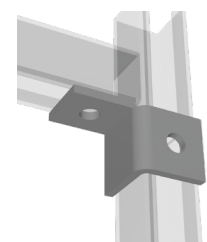
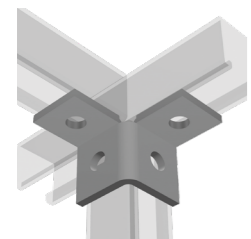

Typenummer	Gatmaat ø mm	Artikel nummer	Materiaal dikte mm	kg stuk	VPE	Kortings groep
------------	-----------------	-------------------	--------------------------	------------	-----	-------------------

Montagehoek

V	NX2120V	14	82232	5	0,29	25 st.	HA
R4	NX2120R4	14	83232	5	0,26	25 st.	HA

Montagehoek

V	NX2130V	14	82233	5	0,22	25 st.	HA
R4	NX2130R4	14	83233	5	0,20	25 st.	HA

Montagehoek

V	NX2140V	14	82234	5	0,22	25 st.	HA
R4	NX2140R4	14	83234	5	0,20	25 st.	HA

Montagehoek 135°

V	NX2150V	14	82235	5	0,25	25 st.	HA
R4	NX2150R4	14	83235	5	0,20	25 st.	HA

Montagehoek 135°

V	NX2155V	14	82239	5	0,31	25 st.	HA
R4	NX2155R4	14	83239	5	0,28	25 st.	HA

Montagehoek 45°

V	NX2160V	14	82236	5	0,25	25 st.	HA
R4	NX2160R4	14	83236	5	0,20	25 st.	HA

Montagehoek, instelbaar ≥ 50°

V	NX2170V	14	82219	5	0,38	20 st.	HA
----------	---------	----	--------------	---	------	--------	----

NX3 - U en Z beugels

Typenummer	Geschikt voor profiel BxH in mm	Artikel nummer	Materiaal dikte mm	kg stuk	VPE	Kortings groep
------------	---------------------------------	----------------	--------------------	---------	-----	----------------

Z - beugel*

V	NX3000V	41x21	82240	5	0,19	25 st.	HA
R4	NX3000R4	41x21	83240	5	0,17	25 st.	HA

Z - beugel*

V	NX3010V	41x41	82241	5	0,23	25 st.	HA
R4	NX3010R4	41x41	83241	5	0,18	25 st.	HA

Z - beugel*

V	NX3015V	41x41	82243	5	0,23	25 st.	HA
R4	NX3015R4	41x41	83243	5	0,22	25 st.	HA

Z - beugel*

V	NX3020V	41x82	82242	5	0,28	25 st.	HA
R4	NX3020R4	41x82	83242	5	0,23	25 st.	HA

Z - beugel*

V	NX3025V	41x41	82244	5	0,31	25 st.	HA
R4	NX3025R4	41x41	83244	5	0,28	25 st.	HA

U - beugel*

V	NX3030V	41x21	82250	5	0,28	25 st.	HA
R4	NX3030R4	41x21	83250	5	0,24	25 st.	HA

U - beugel*

V	NX3040V	41x41	82251	5	0,36	20 st.	HA
R4	NX3040R4	41x41	83251	5	0,29	20 st.	HA

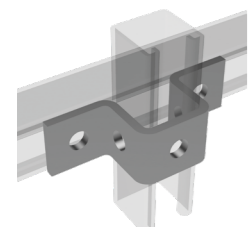
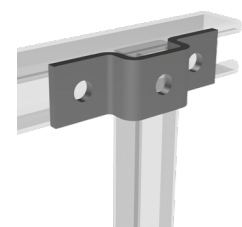
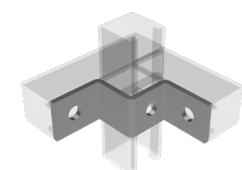
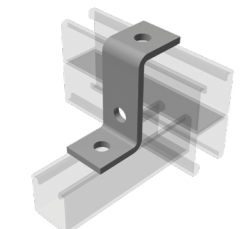
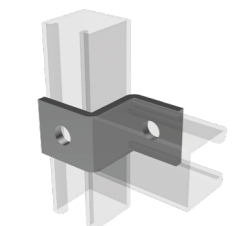
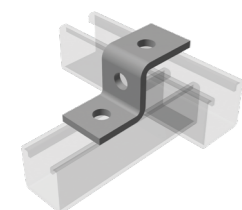
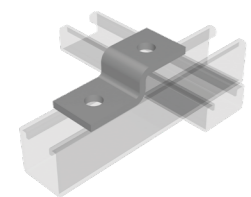

* Gatmaat ø14 mm

NX3 - U en Z beugels

Typenummer	Geschikt voor profiel BxH in mm	Artikel nummer	Materiaal dikte mm	kg stuk	VPE	Kortings groep
------------	---------------------------------	----------------	--------------------	---------	-----	----------------

U - beugel*

V	NX3050V	41x82	82252	5	0,50	10 st.	HA
R4	NX3050R4	41x82	83252	5	0,41	10 st.	HA

U - beugel*

V	NX3060V	41x82	82253	5	0,46	10 st.	HA
R4	NX3060R4	41x82	83253	5	0,34	10 st.	HA

U - beugel*

V	NX3070V	41x82	82254	5	0,30	25 st.	HA
R4	NX3070R4	41x82	83254	5	0,24	25 st.	HA

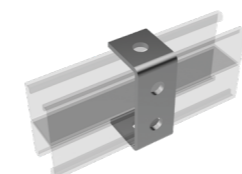
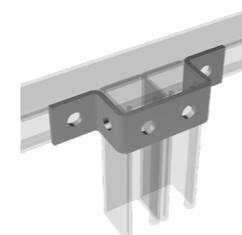
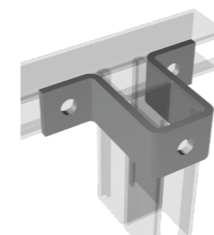

* Gatmaat ø14 mm

NX4 - Koppelstukken

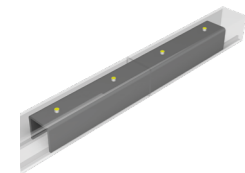
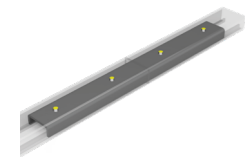
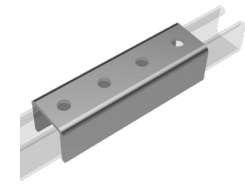
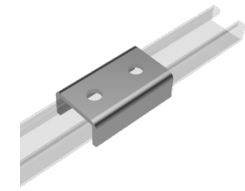

Typenummer	Geschikt voor profiel BxH in mm	Artikel nummer	Materiaal dikte mm	kg stuk	VPE	Kortings groep
------------	---------------------------------	----------------	--------------------	---------	-----	----------------

Koppelstuk extern*, excl. bevestigingsmateriaal

V	NX4000V	41x21	82245	5	0,60	25 st.	HA
R4	NX4000R4	41x21	83245	5	0,58	25 st.	HA

Koppelstuk extern*, excl. bevestigingsmateriaal

V	NX4010V	41x41	82246	5	0,94	10 st.	HA
R4	NX4010R4	41x41	83246	5	0,87	10 st.	HA

Koppelstuk intern, incl. M6 bevestigingsmateriaal

V	NX4020V	41x21	82248	2,5	0,14	25 st.	HA
----------	---------	-------	--------------	-----	------	--------	----

Koppelstuk intern, incl. M6 bevestigingsmateriaal

V	NX4030V	41x41	82249	2,5	0,24	20 st.	HA
----------	---------	-------	--------------	-----	------	--------	----

* Gatmaat \varnothing 14 mm

NX5 - Voetplaten en vleugelstukken

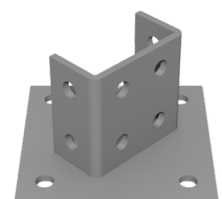
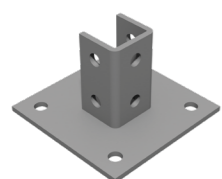
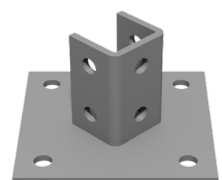
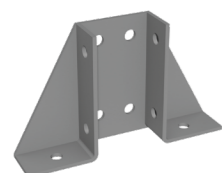
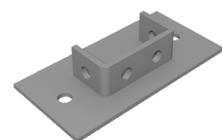
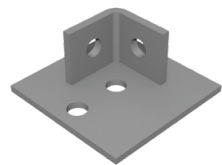

Typenummer	Geschikt voor profiel BxH in mm	Artikel nummer	Materiaal dikte mm	kg stuk	VPE	Kortings groep
------------	---------------------------------	----------------	--------------------	---------	-----	----------------

Voetplaat*

V	NX5000V	41x41	82260	5	0,55	20 st.	HA
R4	NX5000R4	41x41	83260	5	0,51	20 st.	HA

Voetplaat*

V	NX5010V	41x82	82261	5	1,15	5 st.	HA
R4	NX5010R4	41x82	83261	5	1,02	5 st.	HA

Vleugelstuk*

V	NX5020V	41x41	82262	5	1,65	5 st.	HA
R4	NX5020R4	41x41	83262	5	1,46	5 st.	HA

Vleugelstuk*

V	NX5030V	41x82	82263	5	1,85	5 st.	HA
R4	NX5030R4	41x82	83263	5	1,69	5 st.	HA

Voetplaat 45°*

V	NX5040V	41x41	82264	5	1,70	5 st.	HA
R4	NX5040R4	41x41	83264	5	1,54	5 st.	HA

Voetplaat 90°*

V	NX5045V	41x41	82265	5	1,70	5 st.	HA
R4	NX5045R4	41x41	83265	5	1,54	5 st.	HA

Voetplaat 45°*

V	NX5050V	41x82	82266	5	1,80	5 st.	HA
R4	NX5050R4	41x82	83266	5	1,61	5 st.	HA

* Gatmaat ø14 mm

NX5 - Voetplaten en vleugelstukken

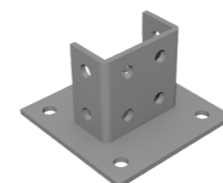

Typenummer	Geschikt voor profiel BxH in mm	Artikel nummer	Materiaal dikte mm	kg stuk	VPE	Kortings groep
------------	---------------------------------	----------------	--------------------	---------	-----	----------------

Voetplaat 90°*

V	NX5055V	41x82	82267	5	1,80	5 st.	HA
R4	NX5055R4	41x82	83267	5	1,61	5 st.	HA

Vleugelstuk*

V	NX5060V	41x41	82268	5	0,58	10 st.	HA
R4	NX5060R4	41x41	83268	5	0,53	10 st.	HA

* Gatmaat ø14 mm

NX6 - Balkklemmen

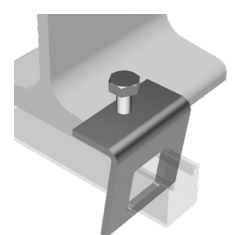
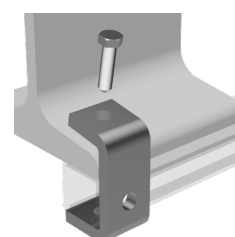
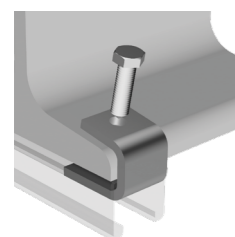
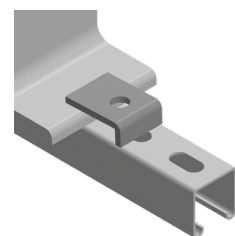
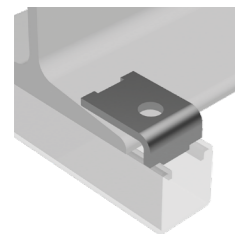
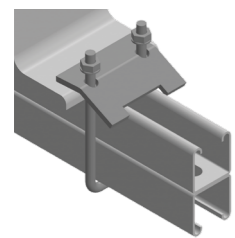
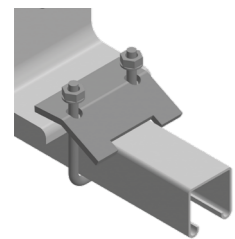

Typenummer	Geschikt voor profiel BxH in mm	Artikel nummer	Klem bereik mm	kg stuk	VPE	Kortings groep
------------	---------------------------------	----------------	----------------	---------	-----	----------------

Balkklem, incl. M10 bevestigingsmateriaal

V	NX6000V	41x41, 41x21, 41x21D	82270	18	0,29	10 st.	HA
R4	NX6000R4	41x41, 41x21, 41x21D	83270	18	0,25	10 st.	HA

Balkklem, incl. M10 bevestigingsmateriaal

V	NX6010V	41x41D	82271	18	0,33	10 st.	HA
R4	NX6010R4	41x41D	83271	18	0,29	10 st.	HA

Balkklem A* met lip, excl. bevestigingsmateriaal

V	NX6020V		82272	13	0,12	50 st.	HA
R4	NX6020R4		83272	13	0,09	50 st.	HA

Balkklem C* zonder lip, excl. bevestigingsmateriaal

V	NX6030V		82273	15	0,11	100 st.	HA
R4	NX6030R4		83273	15	0,09	100 st.	HA

Balkklem U, incl. conepointbout

V	NX6040V		82274	22	0,13	25 st.	HA
R4	NX6040R4		83274	22	0,12	25 st.	HA

Balkklem*, incl. conepointbout

V	NX6050V	41x41, 41x21D	82275	22	0,38	10 st.	HA
R4	NX6050R4	41x41, 41x21D	83275	22	0,34	10 st.	HA

Balkklem W, incl. conepointbout

V	NX6060V	41x41, 41x21D	82276	22	0,43	20 st.	HA
R4	NX6060R4	41x41, 41x21D	83276	22	0,38	20 st.	HA

* Gatmaat ø14 mm

NX6 - Balkklemmen

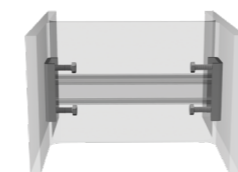
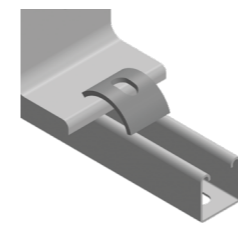
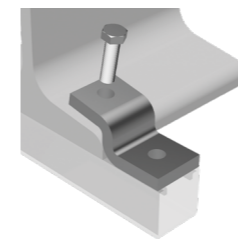

Typenummer	Geschikt voor profiel BxH in mm	Artikel nummer	Klem bereik mm	kg stuk	VPE	Kortings groep
------------	---------------------------------	----------------	----------------	---------	-----	----------------

Balkklem Z*, incl. conepointbout

V	NX6070V		82277	25	0,35	25 st.	HA
R4	NX6070R4		83277	25	0,33	25 st.	HA

Balkklem B met sleuf 11x24 mm

V	NX6080V		82278		0,11	100 st.	HA
R4	NX6080R4		83278		0,09	200 st.	HA

Balkklemset, incl. conepointbouten

V	NX6090V	41x41	82279	400	0,58	10 st.	HA
R4	NX6090R4	41x41	83279	400	0,53	10 st.	HA

* Gatmaat ø14 mm

NX6 - Balkklemmen



Typenummer	Gatmaat	Artikel nummer	Klem bereik mm	kg stuk	VPE	Kortings groep
------------	---------	----------------	----------------	---------	-----	----------------

Balkklem P getapt

E	NX6100E	M6	82600	1 - 18	0,086	50 st.	HA
	NX6110E	M8	82601	1 - 18	0,083	50 st.	HA
	NX6120E	M10	82602	1 - 20	0,146	50 st.	HA
	NX6130E	M12	82603	1 - 26	0,222	50 st.	HA
	NX6140E	M16	82604	1 - 28	0,353	50 st.	HA

Balkklem P met gat

E	NX6150E	ø7	82610	1 - 18	0,084	50 st.	HA
	NX6160E	ø9	82611	1 - 18	0,081	50 st.	HA
	NX6170E	ø11	82612	1 - 20	0,141	50 st.	HA
	NX6180E	ø13	82613	1 - 26	0,218	50 st.	HA
	NX6190E	ø17	82614	1 - 28	0,339	50 st.	HA

Balkklem P getapt

V	NX6100V	M6	82620	1 - 18	0,086	50 st.	HA
---	---------	----	--------------	--------	-------	--------	----

Balkklem P met gat

V	NX6150V	ø7	82630	1 - 18	0,084	50 st.	HA
	NX6160V	ø9	82631	1 - 18	0,081	50 st.	HA
	NX6170V	ø11	82632	1 - 20	0,141	50 st.	HA
	NX6180V	ø13	82633	1 - 26	0,218	50 st.	HA

Balkklem P met gat

R4	NX6160R4	ø9	83611	1 - 16,5	0,170	50 st.	HA
	NX6170R4	ø11	83612	1 - 16,5	0,165	50 st.	HA
	NX6180R4	ø13	83613	1 - 16,5	0,159	50 st.	HA

NX7 - Glijmoeren en hamerkopbouten

Typenummer	Draadmaat	Artikel nummer	Materiaal dikte mm	kg stuk	VPE	Kortings groep
------------	-----------	----------------	--------------------	---------	-----	----------------

Glijmoer zonder veer

E	NX7000E	M6	82300	6	0,028	100 st.	HA
	NX7010E	M8	82301	6	0,026	100 st.	HA
	NX7020E	M10	82302	8	0,035	100 st.	HA
	NX7030E	M12	82303	9	0,040	100 st.	HA
	NX7040E	M16	82304	10	0,045	50 st.	HA
V	NX7000V	M6	82310	6	0,030	100 st.	HA
	NX7010V	M8	82311	6	0,029	100 st.	HA
	NX7020V	M10	82312	8	0,036	100 st.	HA
	NX7030V	M12	82313	9	0,041	100 st.	HA
R4	NX7040V	M16	82314	10	0,048	50 st.	HA
	NX7000R4	M6	83310	6	0,028	100 st.	HA
	NX7010R4	M8	83311	6	0,026	100 st.	HA
	NX7020R4	M10	83312	8	0,035	100 st.	HA
	NX7030R4	M12	83313	9	0,040	100 st.	HA
NX7040R4	M16	83314	10	0,045	50 st.	HA	

Glijmoer met korte veer

E	NX7050E	M6	82320	6	0,029	100 st.	HA
	NX7060E	M8	82321	6	0,027	100 st.	HA
	NX7070E	M10	82322	8	0,035	100 st.	HA
	NX7080E	M12	82323	9	0,041	100 st.	HA
V	NX7050V	M6	82330	6	0,031	100 st.	HA
	NX7060V	M8	82331	6	0,029	100 st.	HA
	NX7070V	M10	82332	8	0,037	100 st.	HA
	NX7080V	M12	82333	9	0,043	100 st.	HA
R4	NX7050R4	M6	83330	6	0,029	100 st.	HA
	NX7060R4	M8	83331	6	0,027	100 st.	HA
	NX7070R4	M10	83332	8	0,035	100 st.	HA
	NX7080R4	M12	83333	9	0,041	100 st.	HA

Glijmoer met lange veer

E	NX7090E	M6	82340	6	0,030	100 st.	HA
	NX7100E	M8	82341	6	0,028	100 st.	HA
	NX7110E	M10	82342	8	0,036	100 st.	HA
	NX7120E	M12	82343	9	0,042	100 st.	HA
V	NX7090V	M6	82350	6	0,032	100 st.	HA
	NX7100V	M8	82351	6	0,030	100 st.	HA
	NX7110V	M10	82352	8	0,038	100 st.	HA
	NX7120V	M12	82353	9	0,044	100 st.	HA
R4	NX7090R4	M6	83350	6	0,030	100 st.	HA
	NX7100R4	M8	83351	6	0,028	100 st.	HA
	NX7110R4	M10	83352	8	0,036	100 st.	HA
	NX7120R4	M12	83353	9	0,042	100 st.	HA

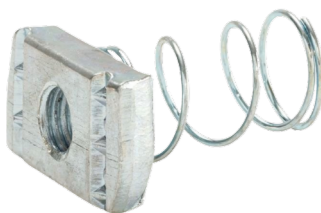

NX7 - Glijmoeren en hamerkopbouten

Typenummer	Draadmaat	Artikel nummer	Materiaal dikte glijmoer mm	kg stuk	VPE	Kortings groep
------------	-----------	----------------	-----------------------------	---------	-----	----------------

Glijmoer met klemplaat

E	NX7130E	M6	82360	6	0,078	100 st.	HA
	NX7140E	M8	82361	6	0,078	100 st.	HA
	NX7150E	M10	82362	8	0,078	100 st.	HA
	NX7160E	M12	82363	9	0,078	100 st.	HA

Glijmoer met fixatie

E	NX7170E	M6	82370	6	0,029	100 st.	HA
	NX7180E	M8	82371	6	0,028	100 st.	HA
	NX7190E	M10	82372	8	0,034	100 st.	HA
	NX7200E	M12	82373	9	0,041	100 st.	HA
V	NX7170V	M6	82380	6	0,030	100 st.	HA
	NX7180V	M8	82381	6	0,030	100 st.	HA
	NX7190V	M10	82382	8	0,037	100 st.	HA
	NX7200V	M12	82383	9	0,041	100 st.	HA
R4	NX7170R4	M6	83380	6	0,029	100 st.	HA
	NX7180R4	M8	83381	6	0,028	100 st.	HA
	NX7190R4	M10	83382	8	0,034	100 st.	HA
	NX7200R4	M12	83383	9	0,041	100 st.	HA

Hamerkopbout, incl. carrosseriering en moer

E	NX7210E	M8x30	82721	6	0,074	50 st.	HA
	NX7220E	M8x40	82722	6	0,080	50 st.	HA
	NX7230E	M8x60	82723	6	0,084	50 st.	HA
	NX7240E	M10x30	82724	8	0,086	50 st.	HA
	NX7250E	M10x40	82725	8	0,097	50 st.	HA
	NX7260E	M10x60	82726	8	0,105	50 st.	HA
	NX7270E	M10x80	82727	8	0,125	50 st.	HA
	NX7280E	M10x100	82728	8	0,132	25 st.	HA
	NX7290E	M12x30	82729	9	0,107	50 st.	HA
	NX7300E	M12x40	82730	9	0,113	50 st.	HA
R4	NX7310E	M12x60	82731	9	0,130	50 st.	HA
	NX7220R4	M8x40	83722	6	0,073	50 st.	HA
	NX7250R4	M10x40	83725	8	0,097	50 st.	HA
NX7300R4	M12x40	83730	9	0,133	50 st.	HA	

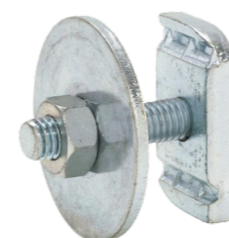
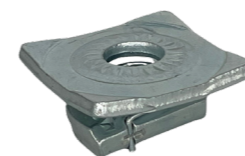

NX8 - Eindkappen en deksels

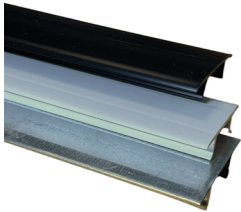

Typenummer	Geschikt voor profiel BxH in mm	Artikel nummer	Kleur	kg stuk	VPE	Kortings groep
------------	---------------------------------	----------------	-------	---------	-----	----------------

Eindkap, inwendig

K	NX8000K	41x21	82292	Zwart	0,005	100 st.	HA
	NX8010K	41x21	82294	Wit	0,005	100 st.	HA
	NX8015K	41x21	82290	Blauw	0,005	100 st.	HA

Eindkap, inwendig

K	NX8020K	41x41	82293	Zwart	0,01	100 st.	HA
	NX8030K	41x41	82295	Wit	0,01	100 st.	HA
	NX8035K	41x41	82291	Blauw	0,01	100 st.	HA

Eindkap, uitwendig

K	NX8040K	41x21	82296	Geel	0,01	20 st.	HA
----------	---------	-------	--------------	------	------	--------	----

Eindkap, uitwendig

K	NX8050K	41x41	82297	Geel	0,01	20 st.	HA
----------	---------	-------	--------------	------	------	--------	----

Deksel railprofiel

K	NX8060K		82020	Zwart	0,48	3 m	HA
	NX8070K		82021	Wit	0,48	3 m	HA
S	NX8080S		82022		1,07	3 m	HA

NX9 - Consoles

Typenummer	Profiel lengte mm	Artikel nummer	Materiaal dikte profiel mm	kg stuk	VPE	Kortings groep
------------	-------------------	----------------	----------------------------	---------	-----	----------------

Console Strut EP 41x41*

V	NX9000V	100	82501	2,5	0,70	1 st.	HA
	NX9010V	150	82521	2,5	0,83	1 st.	HA
	NX9020V	200	82502	2,5	0,95	1 st.	HA
	NX9030V	250	82522	2,5	1,08	1 st.	HA
	NX9040V	300	82503	2,5	1,21	1 st.	HA
	NX9050V	350	82523	2,5	1,34	1 st.	HA
	NX9060V	400	82504	2,5	1,47	1 st.	HA
	NX9070V	450	82524	2,5	1,59	1 st.	HA
	NX9080V	500	82505	2,5	1,72	1 st.	HA
	NX9090V	550	82525	2,5	1,85	1 st.	HA
	NX9100V	600	82506	2,5	1,98	1 st.	HA
	NX9110V	650	82526	2,5	2,11	1 st.	HA
	NX9120V	700	82507	2,5	2,25	1 st.	HA
	NX9130V	750	82527	2,5	2,38	1 st.	HA
	NX9140V	1000	82510	2,5	2,99	1 st.	HA
NX9150V	1500	82515	2,5	4,25	1 st.	HA	
R4	NX9000R4	100	83501	2,5	0,64	1 st.	HA
	NX9010R4	150	83521	2,5	0,78	1 st.	HA
	NX9020R4	200	83502	2,5	0,87	1 st.	HA
	NX9030R4	250	83522	2,5	0,98	1 st.	HA
	NX9040R4	300	83503	2,5	1,10	1 st.	HA
	NX9050R4	350	83523	2,5	1,23	1 st.	HA
	NX9060R4	400	83504	2,5	1,35	1 st.	HA
	NX9070R4	450	83524	2,5	1,47	1 st.	HA
	NX9080R4	500	83505	2,5	1,58	1 st.	HA
	NX9090R4	550	83525	2,5	1,71	1 st.	HA
	NX9100R4	600	83506	2,5	1,83	1 st.	HA
	NX9110R4	650	83526	2,5	1,95	1 st.	HA
	NX9120R4	700	83507	2,5	2,08	1 st.	HA
	NX9130R4	750	83527	2,5	2,20	1 st.	HA
	NX9140R4	1000	83510	2,5	2,81	1 st.	HA
NX9150R4	1500	83515	2,5	3,87	1 st.	HA	

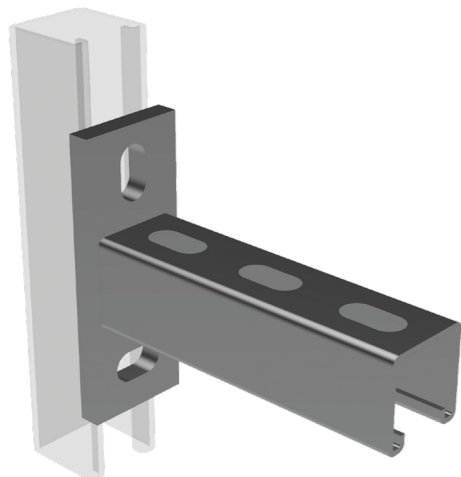

NX9 - Consoles

Typenummer	Profiel lengte mm	Artikel nummer	Materiaal dikte profiel mm	kg stuk	VPE	Kortings groep
------------	-------------------	----------------	----------------------------	---------	-----	----------------

Console Strut DP 2x 41x41*

V	NX9200V	300	82553	2,5	2,21	1 st.	HA	
	NX9210V	350	82573	2,5	2,46	1 st.	HA	
	NX9220V	400	82554	2,5	2,79	1 st.	HA	
	NX9230V	450	82574	2,5	3,09	1 st.	HA	
	NX9240V	500	82555	2,5	3,33	1 st.	HA	
	NX9250V	550	82575	2,5	3,56	1 st.	HA	
	NX9260V	600	82556	2,5	3,79	1 st.	HA	
	NX9270V	650	82576	2,5	4,07	1 st.	HA	
	NX9280V	700	82557	2,5	4,36	1 st.	HA	
	NX9290V	750	82577	2,5	4,73	1 st.	HA	
	NX9300V	1000	82560	2,5	5,64	1 st.	HA	
	NX9310V	1500	82565	2,5	8,09	1 st.	HA	
	R4	NX9200R4	300	83553	2,5	2,07	1 st.	HA
		NX9210R4	350	83573	2,5	2,32	1 st.	HA
		NX9220R4	400	83554	2,5	2,58	1 st.	HA
NX9230R4		450	83574	2,5	2,83	1 st.	HA	
NX9240R4		500	83555	2,5	3,09	1 st.	HA	
NX9250R4		550	83575	2,5	3,34	1 st.	HA	
NX9260R4		600	83556	2,5	3,59	1 st.	HA	
NX9270R4		650	83576	2,5	3,85	1 st.	HA	
NX9280R4		700	83557	2,5	4,11	1 st.	HA	
NX9290R4		750	83577	2,5	4,36	1 st.	HA	
NX9300R4		1000	83560	2,5	5,24	1 st.	HA	
NX9310R4		1500	83565	2,5	7,71	1 st.	HA	

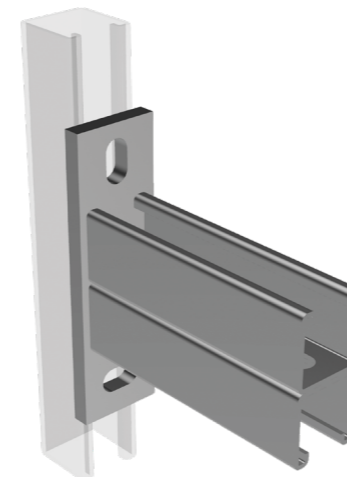

* Sleufgat achterplaat 13x25 mm

* Sleufgat achterplaat 13x25 mm

Bevestigingsmateriaal

Typenummer	Draadmaat	Artikel nummer	 stuk	 VPE	Kortings groep
------------	-----------	----------------	--	---	----------------

Tapbout - DIN 933

E	Tapbout	M6x20	82751	0,0058	100 st.	HA
	Tapbout	M6x25	82752	0,0067	100 st.	HA
	Tapbout	M6x35	82754	0,0084	100 st.	HA
	Tapbout	M6x40	82755	0,0092	100 st.	HA
	Tapbout	M8x20	82761	0,0123	100 st.	HA
	Tapbout	M8x25	82762	0,0139	100 st.	HA
	Tapbout	M8x30	82763	0,0150	100 st.	HA
	Tapbout	M8x40	82765	0,0203	100 st.	HA
	Tapbout	M10x20	82771	0,0212	100 st.	HA
	Tapbout	M10x25	82772	0,0237	100 st.	HA
	Tapbout	M10x30	82773	0,0262	100 st.	HA
	Tapbout	M10x40	82775	0,0312	100 st.	HA
V	Tapbout	M10x50	82777	0,0362	100 st.	HA
	Tapbout	M10x60	82779	0,0413	100 st.	HA
	Tapbout	M10x70	82781	0,0456	100 st.	HA
	Tapbout	M12x20	82791	0,0333	100 st.	HA
	Tapbout	M12x25	82792	0,0341	100 st.	HA
	Tapbout	M12x30	82793	0,0377	100 st.	HA
	Tapbout	M12x40	82795	0,0449	100 st.	HA
	Tapbout	M6x20 ISO	82801	0,0060	100 st.	HA
	Tapbout	M6x25 ISO	82802	0,0068	100 st.	HA
	Tapbout	M6x35 ISO	82804	0,0086	100 st.	HA
	Tapbout	M6x40 ISO	82805	0,0095	100 st.	HA
	Tapbout	M8x20 ISO	82811	0,0127	100 st.	HA
R4	Tapbout	M8x25 ISO	82812	0,0144	100 st.	HA
	Tapbout	M8x30 ISO	82813	0,0153	100 st.	HA
	Tapbout	M8x40 ISO	82815	0,0205	100 st.	HA
	Tapbout	M10x20 ISO	82821	0,0214	100 st.	HA
	Tapbout	M10x25 ISO	82822	0,0238	100 st.	HA
	Tapbout	M10x30 ISO	82823	0,0265	100 st.	HA
	Tapbout	M10x40 ISO	82825	0,0316	100 st.	HA
	Tapbout	M10x50 ISO	82827	0,0367	100 st.	HA
	Tapbout	M10x60 ISO	82829	0,0415	100 st.	HA
	Tapbout	M10x70 ISO	82831	0,0458	100 st.	HA
	Tapbout	M12x20 ISO	82841	0,0335	100 st.	HA
	Tapbout	M12x25 ISO	82842	0,0344	100 st.	HA
Tapbout	M12x30 ISO	82843	0,0380	100 st.	HA	
Tapbout	M12x40 ISO	82845	0,0452	100 st.	HA	
Tapbout	M6x20	83801	0,0058	100 st.	HA	
Tapbout	M6x25	83802	0,0067	100 st.	HA	
Tapbout	M6x35	83804	0,0084	100 st.	HA	
Tapbout	M6x40	83805	0,0092	100 st.	HA	
Tapbout	M8x20	83811	0,0123	100 st.	HA	
Tapbout	M8x25	83812	0,0139	100 st.	HA	
Tapbout	M8x30	83813	0,0150	100 st.	HA	
Tapbout	M8x40	83815	0,0203	100 st.	HA	
Tapbout	M10x20	83821	0,0212	100 st.	HA	
Tapbout	M10x25	83822	0,0237	100 st.	HA	
Tapbout	M10x30	83823	0,0262	100 st.	HA	
Tapbout	M10x40	83825	0,0312	100 st.	HA	
Tapbout	M10x50	83827	0,0362	100 st.	HA	
Tapbout	M10x60	83829	0,0413	100 st.	HA	
Tapbout	M10x70	83831	0,0456	100 st.	HA	
Tapbout	M12x20	83841	0,0333	100 st.	HA	
Tapbout	M12x25	83842	0,0341	100 st.	HA	
Tapbout	M12x30	83843	0,0377	100 st.	HA	
Tapbout	M12x40	83845	0,0449	100 st.	HA	



Bevestigingsmateriaal

Typenummer	Draadmaat	Artikel nummer	 stuk	 VPE	Kortings groep
------------	-----------	----------------	--	---	----------------

Conepointbout

V	Conepointbout	M10x40 ISO	82955	0,0312	100 st.	HA
R4	Conepointbout	M10x40	83955	0,0310	100 st.	HA



Moer - DIN 934

E	Moer	M6	82850	0,003	100 st.	HA
	Moer	M8	82851	0,005	100 st.	HA
	Moer	M10	82852	0,010	100 st.	HA
	Moer	M12	82853	0,017	100 st.	HA
V	Moer	M6 ISO	82860	0,004	100 st.	HA
	Moer	M8 ISO	82861	0,005	100 st.	HA
	Moer	M10 ISO	82862	0,012	100 st.	HA
	Moer	M12 ISO	82863	0,018	100 st.	HA
R4	Moer	M6	83860	0,003	100 st.	HA
	Moer	M8	83861	0,005	100 st.	HA
	Moer	M10	83862	0,010	100 st.	HA
	Moer	M12	83863	0,017	100 st.	HA

Flensmoer - DIN 6923

E	Flensmoer	M6	82870	0,003	100 st.	HA
	Flensmoer	M8	82871	0,007	100 st.	HA
	Flensmoer	M10	82872	0,014	100 st.	HA
	Flensmoer	M12	82873	0,023	100 st.	HA
V	Flensmoer	M6 ISO	82880	0,004	100 st.	HA
	Flensmoer	M8 ISO	82881	0,009	100 st.	HA
	Flensmoer	M10 ISO	82882	0,016	100 st.	HA
	Flensmoer	M12 ISO	82883	0,026	100 st.	HA
R4	Flensmoer	M6	83880	0,003	100 st.	HA
	Flensmoer	M8	83881	0,007	100 st.	HA
	Flensmoer	M10	83882	0,014	100 st.	HA
	Flensmoer	M12	83883	0,023	100 st.	HA

Bevestigingsmateriaal

Typenummer	Voor draadmaat	Artikel nummer	Lengte mm	kg stuk	VPE	Kortings groep
------------	----------------	----------------	-----------	---------	-----	----------------

Sluistring - DIN 125A / DIN 126

E	Sluistring	M6	82890		0,0010	100 st.	HA
	Sluistring	M8	82891		0,0018	100 st.	HA
	Sluistring	M10	82892		0,0036	100 st.	HA
	Sluistring	M12	82893		0,0063	100 st.	HA
V	Sluistring	M6	82900		0,0010	100 st.	HA
	Sluistring	M8	82901		0,0019	100 st.	HA
	Sluistring	M10	82902		0,0038	100 st.	HA
R4	Sluistring	M12	82903		0,0066	100 st.	HA
	Sluistring	M6	83900		0,0010	100 st.	HA
	Sluistring	M8	83901		0,0018	100 st.	HA
	Sluistring	M10	83902		0,0036	100 st.	HA
	Sluistring	M12	83903		0,0063	100 st.	HA

Carrosseriering - DIN 9021

E	Carrosseriering	M6	82910		0,0030	100 st.	HA
	Carrosseriering	M8	82911		0,0070	100 st.	HA
	Carrosseriering	M10	82912		0,0120	100 st.	HA
	Carrosseriering	M12	82913		0,0220	100 st.	HA
V	Carrosseriering	M6	82920		0,0033	100 st.	HA
	Carrosseriering	M8	82921		0,0075	100 st.	HA
	Carrosseriering	M10	82922		0,0124	100 st.	HA
	Carrosseriering	M12	82923		0,0225	100 st.	HA
R4	Carrosseriering	M6	83920		0,0030	100 st.	HA
	Carrosseriering	M8	83921		0,0070	100 st.	HA
	Carrosseriering	M10	83922		0,0120	100 st.	HA
	Carrosseriering	M12	83923		0,0220	100 st.	HA

Veerring - DIN 127B

E	Veerring	M6	82930		0,0010	100 st.	HA
	Veerring	M8	82931		0,0020	100 st.	HA
	Veerring	M10	82932		0,0030	100 st.	HA
	Veerring	M12	82933		0,0040	100 st.	HA
V	Veerring	M6	82940		0,0013	100 st.	HA
	Veerring	M8	82941		0,0023	100 st.	HA
	Veerring	M10	82942		0,0033	100 st.	HA
	Veerring	M12	82943		0,0043	100 st.	HA
R4	Veerring	M6	83940		0,0010	100 st.	HA
	Veerring	M8	83941		0,0020	100 st.	HA
	Veerring	M10	83942		0,0030	100 st.	HA
	Veerring	M12	83943		0,0040	100 st.	HA

Verbindingsmoer - DIN 6334

E	Verbindingsmoer	M6	82650	18	0,008	100 st.	HA
	Verbindingsmoer	M8	82651	24	0,017	100 st.	HA
	Verbindingsmoer	M10	82652	30	0,030	100 st.	HA
	Verbindingsmoer	M12	82653	36	0,057	100 st.	HA
V	Verbindingsmoer	M10 ISO	82657	30	0,033	100 st.	HA
	Verbindingsmoer	M12 ISO	82658	36	0,061	100 st.	HA
R4	Verbindingsmoer	M6	83655	18	0,008	100 st.	HA
	Verbindingsmoer	M8	83656	24	0,017	100 st.	HA
	Verbindingsmoer	M10	83657	30	0,030	100 st.	HA
	Verbindingsmoer	M12	83658	36	0,057	100 st.	HA



Bevestigingsmateriaal

Typenummer	Draadmaat Inhoud ml	Artikel nummer	Lengte mm	kg stuk	VPE	Kortings groep
------------	---------------------	----------------	-----------	---------	-----	----------------

Draadstang - DIN 975

E	Draadstang	M6	82661	1000	0,18	1 st.	HA	
	Draadstang	M6	82663	3000	0,54	1 st.	HA	
	Draadstang	M8	82665	1000	0,34	1 st.	HA	
	Draadstang	M8	82666	2000	0,68	1 st.	HA	
	Draadstang	M8	82667	3000	1,02	1 st.	HA	
	Draadstang	M10	82671	1000	0,50	1 st.	HA	
	Draadstang	M10	82672	2000	1,00	1 st.	HA	
	Draadstang	M10	82673	3000	1,50	1 st.	HA	
	Draadstang	M12	82675	1000	0,73	1 st.	HA	
	Draadstang	M12	82677	3000	2,19	1 st.	HA	
	V	Draadstang	M8 ISO	82681	1000	0,35	1 st.	HA
		Draadstang	M10 ISO	82685	1000	0,52	1 st.	HA
Draadstang		M10 ISO	82687	3000	1,56	1 st.	HA	
Draadstang		M12 ISO	82691	1000	0,75	1 st.	HA	
R4	Draadstang	M12 ISO	82693	3000	2,25	1 st.	HA	
	Draadstang	M6	83675	1000	0,18	1 st.	HA	
	Draadstang	M6	83677	3000	0,54	1 st.	HA	
	Draadstang	M8	83681	1000	0,34	1 st.	HA	
	Draadstang	M8	83683	3000	1,02	1 st.	HA	
	Draadstang	M10	83685	1000	0,50	1 st.	HA	
	Draadstang	M10	83687	3000	1,50	1 st.	HA	
	Draadstang	M12	83691	1000	0,73	1 st.	HA	
	Draadstang	M12	83693	3000	2,19	1 st.	HA	

Zinkspray

Zinkspray	400 ml	82980	Mat	0,54	1 st.	HA
Zinkspray	400 ml	82981	Glans	0,54	1 st.	HA

Zinkverf

Zinkverf	250 ml	82982		0,60	1 st.	HA
Zinkverf	500 ml	82983		1,15	1 st.	HA

Dopsleutel

E	Dopsleutel	M10/B-21	82950	Sleutel 17	0,074	1 st.	HA
	Dopsleutel	M10/B-41	83950	Sleutel 17	0,160	1 st.	HA



by



Niedax Kleinhuis B.V.

Bijsterhuizen 20-05A | 6604 LH Wijchen
Tel: +31 (0) 24 3788533
info@niedax.nl | www.niedax.nl

Niedax Kleinhuis n.v.

Tulpenstraat 2 | B-9810 Nazareth-De Pinte
Tel: +32 (0) 92 200790
info@niedax.be | www.niedax.be