

Kabelkanalen Cable ducts

Tray H28(R)/H53(R)
Tray H78R/H103R



kabelbaan

sendzimir verzinkt
sendzimir verzinkt en gelakt
thermisch verzinkt

cable duct

mill galvanized
mill galvanized and coated
hot dip galvanized



Det Norske Veritas (DNV) en Germanischer Lloyd (GL)



Tray H28/H28R

Tray H53/H53R

Kabelbaan, Sendzimir verzinkt
Sendzimir verzinkt en gelakt
Thermisch verzinkt

Tray H78R

Tray H103R

Cable duct, Mill galvanized
Mill galvanized and coated
Hot dip galvanized

Tray

- sendzimir verzinkt EN 10142
- sendzimir verzinkt en gelakt in RAL 9002
- thermisch verzinkt NEN-EN-ISO 1461
- chemisch resistent
- afsluitbaar d.m.v. deksels (alleen H53R)
- standaardlengte 3000 mm

Op verzoek:

- afwijkende breedte-, hoogte- en diktematen
- gesloten uitvoering

- mill galvanized EN 10142
- mill galvanized and coated in RAL 9002
- hot dip galvanized NEN-EN-ISO 1461
- chemically resistant
- a wide range of covers available (only H53R)
- standard length 3000 mm

On request:

- deviant width, heights and thickness
- solid type

Tray H28/H28R

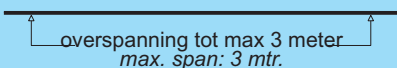
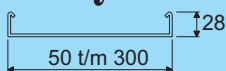

- mat. dikte s.v. 1,0 mm
- mat. dikte s.v.-gelakt 1,0 mm
- mat. dikte th. verz. 1,5 mm
- alle deksels dikte 1,0 mm
- hulpstukken R = 60 dikte 1,0 mm

- mat. thickness mill galv. 1.0 mm
- mat. thickness mill galv./coated 1.0 mm
- mat. thickness hot dip galv. 1.5 mm
- covers thickness 1.0 mm
- fittings R = 60 thickness 1.0 mm

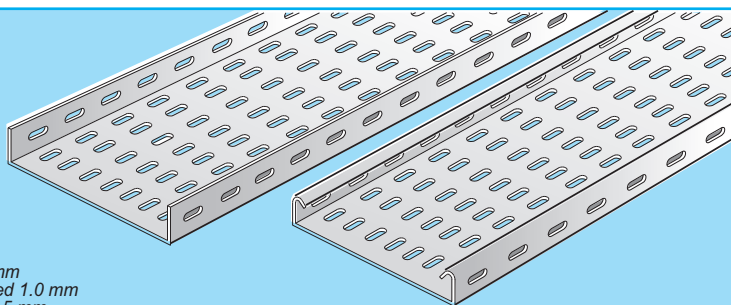

Tray H53/H53R

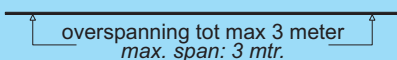
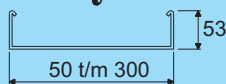

- mat. dikte s.v. 1,0 mm
- mat. dikte s.v.-gelakt 1,0 mm
- mat. dikte th. verz. 1,5 mm
- alle deksels dikte 1,0 mm
- hulpstukken R = 60 dikte 1,0 mm

- mat. thickness mill galv. 1.0 mm
- mat. thickness mill galv./coated 1.0 mm
- mat. thickness hot dip galv. 1.5 mm
- covers thickness 1.0 mm
- fittings R = 60 thickness 1.0 mm

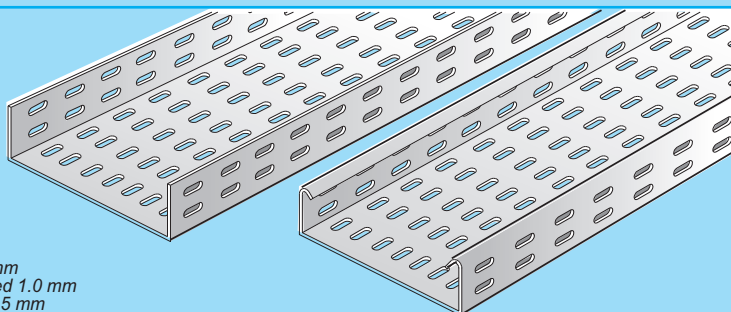

Tray H78R

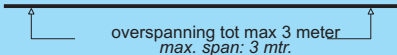
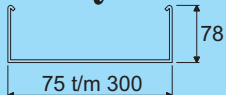

- mat. dikte s.v. 1,0 mm
- mat. dikte s.v.-gelakt 1,0 mm
- mat. dikte th. verz. 1,5 mm
- alle deksels dikte 1,0 mm
- hulpstukken R = 60 dikte 1,0 mm
- mat. thickness mill galv. 1.0 mm
- mat. thickness mill galv./coated 1.0 mm
- mat. thickness hot dip galv. 1.5 mm
- covers thickness 1.0 mm
- fittings R = 60 thickness 1.0 mm

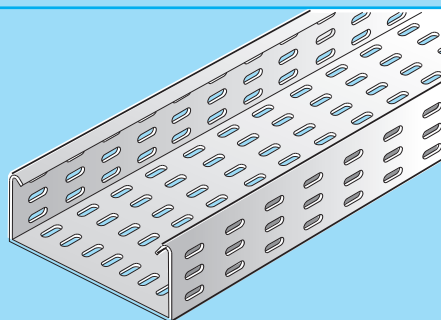

Tray H103R

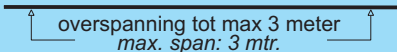
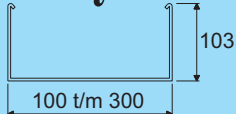

- mat. dikte s.v. 1,0 mm
- mat. dikte s.v.-gelakt 1,0 mm
- mat. dikte th. verz. 1,5 mm
- alle deksels dikte 1,0 mm
- hulpstukken R = 60 dikte 1,0 mm
- mat. thickness mill galv. 1.0 mm
- mat. thickness mill galv./coated 1.0 mm
- mat. thickness hot dip galv. 1.5 mm
- covers thickness 1.0 mm
- fittings R = 60 thickness 1.0 mm

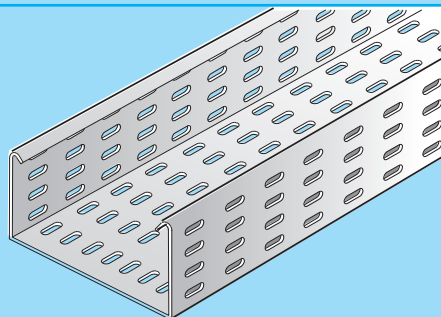

Kabelkanalen Tray

Cable ducts Tray

Kabelbaan, Sendzimir verzinkt
Sendzimir verzinkt en gelakt
Thermisch verzinkt

Cable duct, Mill galvanized
Mill galvanized and coated
Hot dip galvanized

Tray

C1-1 Algemeen	Pag.	C1-1 General	Page
<ul style="list-style-type: none">• Inhoudsopgave	C1-1-2	<ul style="list-style-type: none">• Table of contents	C1-1-2
<ul style="list-style-type: none">• Toepassingen	C1-1-3	<ul style="list-style-type: none">• Applications	C1-1-3
<ul style="list-style-type: none">• Technische gegevens	C1-1-4	<ul style="list-style-type: none">• Technical specifications	C1-1-4
<ul style="list-style-type: none">• Belastbaarheidstabellen	C1-1-5	<ul style="list-style-type: none">• Loading tabels	C1-1-5
<ul style="list-style-type: none">• Systeemoverzicht	C1-1-6	<ul style="list-style-type: none">• Survey of the system	C1-1-6
C1-2 Tray H28/Tray H28R		C1-2 Tray H28/Tray H28R	
<ul style="list-style-type: none">• Kabelkanalen	C1-2-1	<ul style="list-style-type: none">• Cable ducts/Covers	C1-2-1
<ul style="list-style-type: none">• Koppelplaten/Scheidingsschot	C1-2-2	<ul style="list-style-type: none">• Splice plates/Separation strip	C1-2-2
<ul style="list-style-type: none">• Eindschot/Hulpstukken/Deksels	C1-2-3/10	<ul style="list-style-type: none">• Endplate/Fittings/Covers	C1-2-3/10
C1-3 Tray H53/Tray H53R		C1-3 Tray H53/Tray H53R	
<ul style="list-style-type: none">• Kabelkanalen	C1-3-1	<ul style="list-style-type: none">• Cable ducts/Covers	C1-3-1
<ul style="list-style-type: none">• Koppelplaten/Scheidingsschot	C1-3-4	<ul style="list-style-type: none">• Splice plates/Separation strip	C1-3-4
<ul style="list-style-type: none">• Eindschot/Hulpstukken/Deksels	C1-3-4/14	<ul style="list-style-type: none">• Endplate/Fittings/Covers	C1-3-4/14
C1-4 Tray H78R		C1-4 Tray H78R	
<ul style="list-style-type: none">• Kabelkanalen	C1-4-1	<ul style="list-style-type: none">• Cable ducts/Covers	C1-4-1
<ul style="list-style-type: none">• Koppelplaten/Scheidingsschot	C1-4-4	<ul style="list-style-type: none">• Splice plates/Separation strip	C1-4-4
<ul style="list-style-type: none">• Eindschot/Hulpstukken/Deksels	C1-4-4/14	<ul style="list-style-type: none">• Endplate/Fittings/Covers	C1-4-4/14
C1-5 Tray H103R		C1-5 Tray H103R	
<ul style="list-style-type: none">• Kabelkanalen	C1-5-1	<ul style="list-style-type: none">• Cable ducts/Covers	C1-5-1
<ul style="list-style-type: none">• Koppelplaten/Scheidingsschot	C1-5-4	<ul style="list-style-type: none">• Splice plates/Separation strip	C1-5-4
<ul style="list-style-type: none">• Eindschot/Hulpstukken/Deksels	C1-5-4/14	<ul style="list-style-type: none">• Endplate/Fittings/Covers	C1-5-4/14

Tray Toepassingen

Tray Applications

Tray



Technische gegevens

Technical specifications

Kenmerken

Features

Materiaal kwaliteit

De kabelkanalen, koppelplaten, hulpstukken, deksels alsmede de ophang-inrichtingen worden thermisch verzinkt volgens NEN-EN-ISO 1461, of sendzimir verzinkt volgens EN-10142 en gelakt in RAL 9002.

(volgens deze norm kan bij dunne plaat vervorming optreden)

Systeem

Tray is een "light duty" geperforeerd vlakbodem systeem. Tray wordt geleverd in lengten van 3000 mm en zijn in type H28/28R, type H53/53R, type H78R en H103R verkrijgbaar.

Tray bevat doorlopende sleufperforaties in de lengterichting, aangebracht volgens de EMC richtlijnen. Het systeem is volledig afsluitbaar met deksels type R in combinatie met dekselveren.

Hulpstukken

Hulpstukken worden geleverd met een standaard radius van 60 mm. Het systeem kan worden gecompleteerd met diverse plafond- en wandbevestigingen (zie hoofdstuk **E**).

Material Quality

The cable ducts, splice plates, fittings, covers and suspension constructions are hot dip galvanized according to NEN-EN-ISO 1461, or mill galvanized according to EN-10142 and coated in RAL 9002.

(this norm allows deformation of thin plates)

System

Tray is a "light duty" perforated cable duct system. Tray is supplied in lengths of 3000 mm and are for type H28/28R, type H53/53R, type H78R and type H103R available.

Tray has a continuous row of slotted perforations lengthwise, in accordance with EMC-standards. The system is completely lockable with covers Type R in combination with cover springs.

Fittings

*Fittings are supplied with a standard radius of 60 mm. The system can be completed with several ceiling- and wall-attachments (see chapter **E**).*

Technische gegevens

Technical specifications

Overspanningsklasse en belastbaarheid

Span category and load-bearing capacity

Tray

Belastbaarheid

Tray is belastbaar volgens de in de tabellen opgenomen gegevens. Om het draagvermogen te handhaven op plaatsen waar hulpstukken bevestigd zitten, moeten daar extra steunpunten worden aangebracht.

Overspanningsklasse

Tray kan, met inachtneming van de maximale belastbaarheid, worden toegepast over een afstand van maximaal 3000 mm.

Maatwerk

Speciale materialen en maatvoeringen kunnen op klant specificaties gefabriceerd worden.

Belastinggrafiek

Bij: - gelijkmatige belasting
- doorbuiging van max. 1/300
- belasting van ca. 100 N per 100 mm kabelkanaalbreedte.

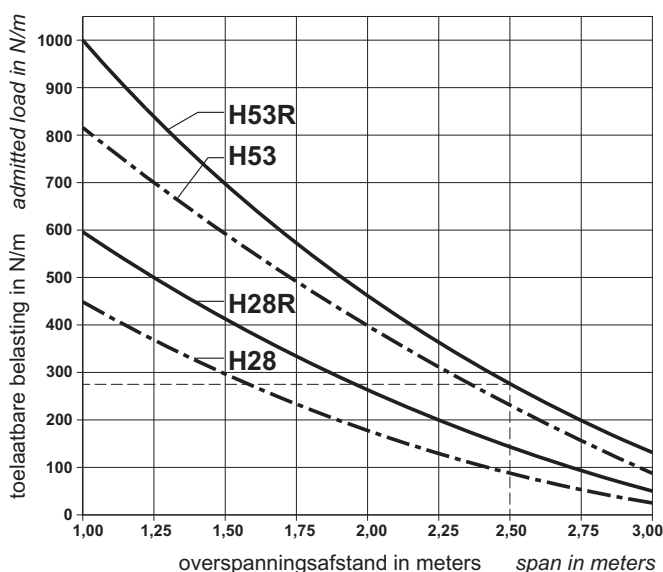

NB: Bij de gevonden overspanningen moeten
- gemeten vanuit de ondersteuning -
- de koppelingen plaatsvinden binnen een
kwart van de overspanning.

Load-bearing Capacity

Tray can be loaded within the limits indicated in the carrying capacity tables. In order to maintain the carrying capacity, additional support points are needed where fittings have been applied.

Span Category

Tray can be installed over a maximum distance of 3000 mm.

Custom-made goods

Special materials and sizes can be made-to-measure on customer request.

Loading diagrams

With: - uniform load
- deflection of max. 1/300
- load of max. 100 N per 100 mm cable duct width.

Voorbeeld:

Kabelkanaal H53R 250 mm breed.
Belasting is dan ca. 250 N/m.
Eigen gewicht per meter ca. 30 N/m.
Totale belasting ca. 280 N/m.
Max. overspanning is dan 2,5 meter.
(zie grafiek)

Example:

Cable duct H53R 250 mm wide.
Load in this case about 250 N/m.
Duct weight per meter about 30 N/m.
Total load about 280 N/m.
Max. span in this case 2.5 meter.
(see diagram)

NB: In case of found spans, optimum splice locations are at approximate quarter-points (one-fourth the clear span distance) from the support.

Systemoverzicht Tray

Survey of the system Tray

Benaming / Description	H28R		H53R	
	pos. nr. item no.	pagina page	pos. nr. item no.	pagina page
Kabelkanaal / Cable duct	1	C1-2-1	17	C1-3-1
Koppelplaat / Splice plate	2	C1-2-2	18	C1-3-2
Scharnierende koppelplaat / Hinged splice plate	3	C1-2-2	19	C1-3-2
Scheidingsschot / Separation strip	4	C1-2-2	20	C1-3-2
Eindschot-verloopkoppelplaat / Endplate-reducing plate	5	C1-2-3	21	C1-3-3
Verloopstuk / Reducer	6	C1-2-3	22	C1-3-3
Aanzethoekstuk / Universal corner piece	7	C1-2-3	23	C1-3-4
Hoekstuk 45° / Corner piece 45°	8	C1-2-4	24	C1-3-4
Hoekstuk 90° / Corner piece 90°	9	C1-2-4	25	C1-3-5
Aftakstuk / Branch	10	C1-2-5	26	C1-3-5
Driewegstuk (gelijkzijdig) / Equal tee piece	11	C1-2-5/6	27	C1-3-6/8
Vierwegstuk / Cross piece	12	C1-2-7	28	C1-3-9
Stijgstuk 45° / Vertical inner bend 45°	13	C1-2-8	29	C1-3-10
Stijgstuk 90° / Vertical inner bend 90°	14	C1-2-8	30	C1-3-10
Vervalstuk 45° / Vertical outer bend 45°	15	C1-2-9	31	C1-3-11
Vervalstuk 90° / Vertical outer bend 90°	16	C1-2-9	32	C1-3-11
Montagerail / Hanger channel	33/34	E	33/34	E
Plafondbeugel-L / Ceiling brace-L	35	E	35	E
Railplaat / Rail plate	36	E	36	E
Moerplaat / Nut plate	37	E	37	E
Open ophangbeugel / Open suspension bracket	38	E	38	E
Open ophangbeugel-L / Open suspension bracket-L	39	E	39	E
Console-L / Bracket-L	40	E	40	E
Console-M / Bracket-M	41	E	41	E
Console-Z / Console-Z	42	E	42	E
Console-ZV / Bracket-ZV	43	E	43	E
Consolehanger-ZV / Bracket hanger-ZV	44	E	44	E
Universele montageplaat / Mounting plate for socket box	45	E	45	E
Dekselklem / Cover clamp	46	C1-3-3	46	C1-3-3
Dekselveer / Cover spring	47	C1-3-3	47	C1-3-3
Borgbeugel / Fixing brace	48	E	48	E
Spanklauw-B / Beam clamp-B	49	E	49	E

Tray

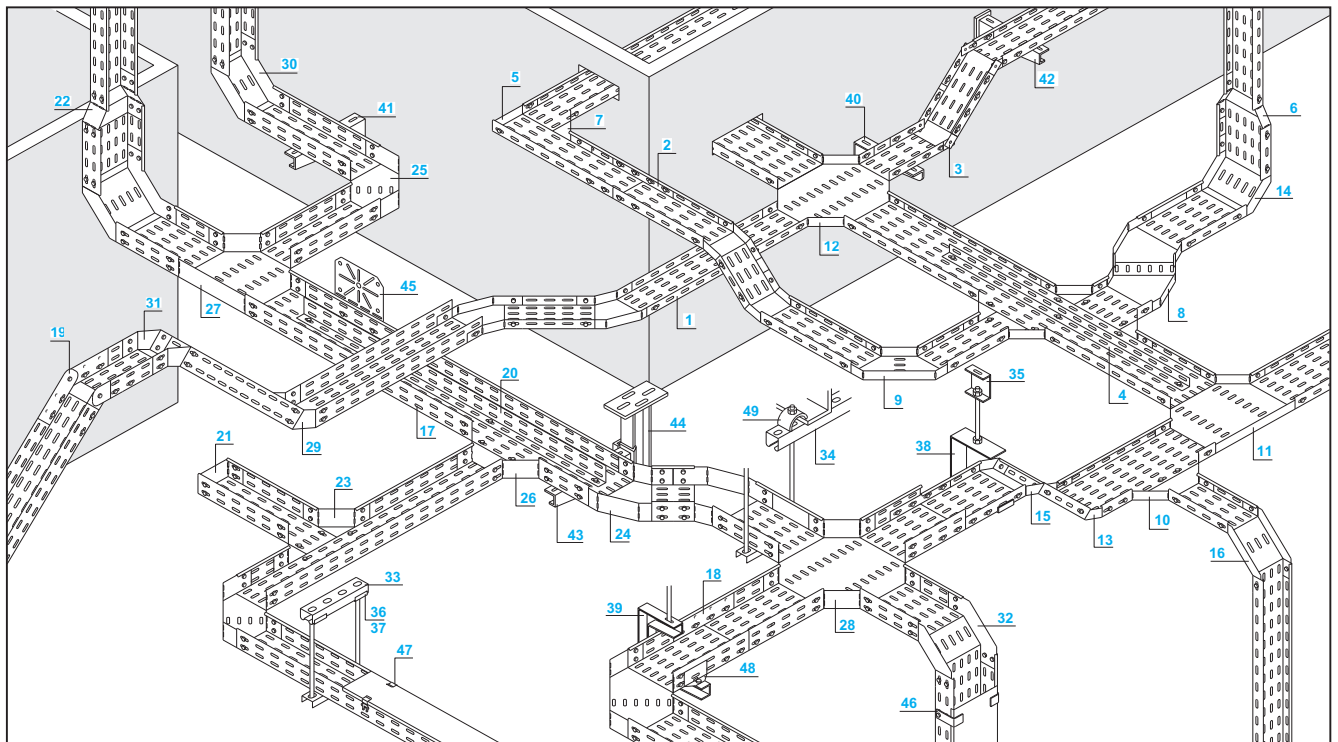

Tray

H28

H28R

Kabelkanaal H28
Cable duct H28

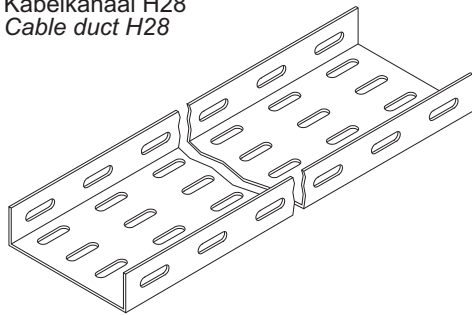

Kabelkanaal H28R
Cable duct H28R

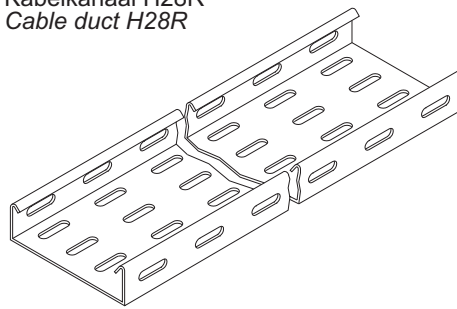

Tray

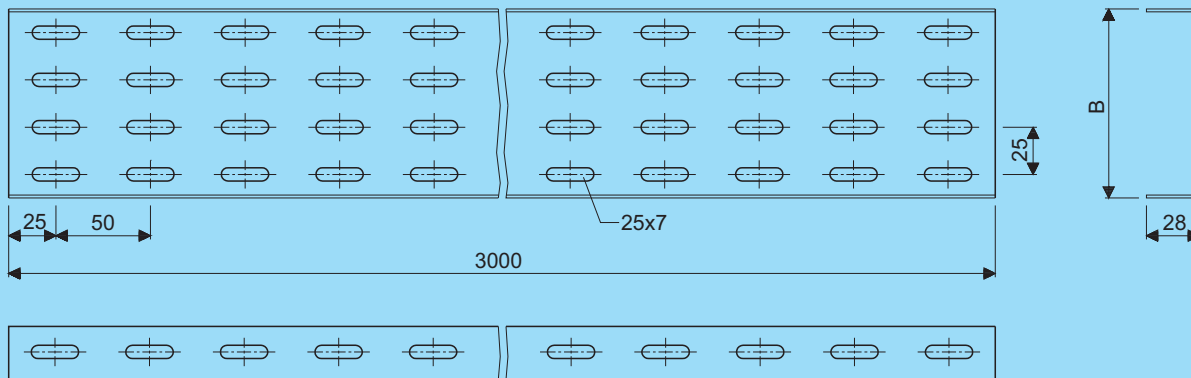

Kabelkanaal - H28 Cable duct - H28					
B W	Artikel nr. Product no.			Artikel nr. Product no.	
	Sendz.v. Mill galv.	Sendz.v. gelakt Mill galv./coated	Gewicht Weight	Therm.v. Hot dip galv.	Gewicht Weight
50	31041.152	31041.158	1,97	31041.153	3,19
75	31042.152	31042.158	2,46	31042.153	4,01
100	31043.152	31043.158	2,95	31043.153	4,83
150	31044.152	31044.158	3,94	31044.153	6,46
200	31045.152	31045.158	4,92	31045.153	8,10
250	31046.152	31046.158	5,90	31046.153	9,73
300	31047.152	31047.158	6,89	31047.153	11,37

sleufperforatie in de lengterichting in verband met EMC

perforation slots lengthways in view of EMC

bestel de benodigde koppelplaten apart, zij worden niet geleverd bij de kanalen
order splice plates as separate items, they are not supplied with the cable ducts

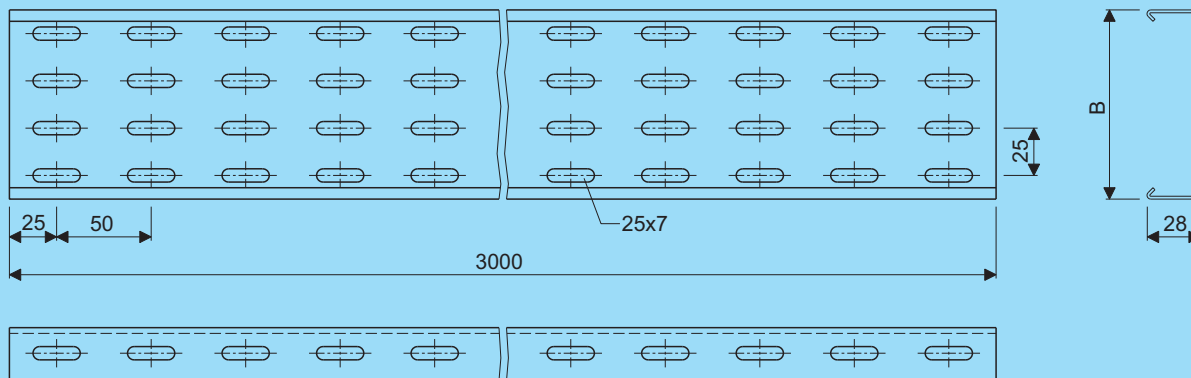

Kabelkanaal - H28R Cable duct - H28R					
B W	Artikel nr. Product no.			Artikel nr. Product no.	
	Sendz.v. Mill galv.	Sendz.v. gelakt Mill galv./coated	Gewicht Weight	Therm.v. Hot dip galv.	Gewicht Weight
50	31081.152	31081.158	2,30	31081.153	3,82
75	31082.152	31082.158	2,80	31082.153	4,64
100	31083.152	31083.158	3,29	31083.153	5,45
150	31084.152	31084.158	4,27	31084.153	7,09
200	31085.152	31085.158	5,26	31085.153	8,72
250	31086.152	31086.158	6,24	31086.153	10,36
300	31087.152	31087.158	7,22	31087.153	11,99

sleufperforatie in de lengterichting in verband met EMC

perforation slots lengthways in view of EMC

bestel de benodigde koppelplaten apart, zij worden niet geleverd bij de kanalen
order splice plates as separate items, they are not supplied with the cable ducts

Tray H28

Koppelplaat
Splice plate

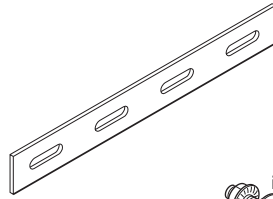

Scharnierende koppelplaat
Hinged splice plate

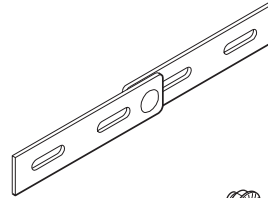

Scheidingsshot
Separation strip

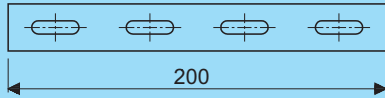
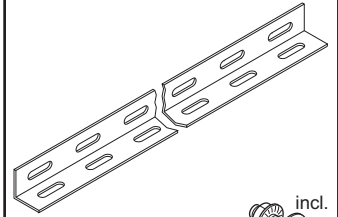

Koppelplaat
Splice plate

Artikel nr. Product no.			Artikel nr. Product no.	
Senz.v. Mill galv.	Senz.v. gelakt Mill galv./coated	Gewicht Weight	Therm.v. Hot dip galv.	Gewicht Weight
31122.152	31122.158	0,07	31122.153	0,09

levering inclusief:
4 slotbouten M6 x 12
en flensmoeren

supplied complete with:
4 lock screws M6 x 12
and flange nuts

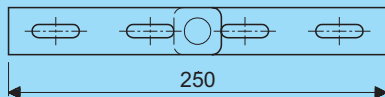

Scharnierende koppelplaat
Hinged splice plate

Artikel nr. Product no.			Artikel nr. Product no.	
Senz.v. Mill galv.	Senz.v. gelakt Mill galv./coated	Gewicht Weight	Therm.v. Hot dip galv.	Gewicht Weight
31141.152	31141.158	0,08	31141.153	0,09

levering inclusief:
5 slotbouten M6 x 12
en flensmoeren

supplied complete with:
5 lock screws M6 x 12
and flange nuts

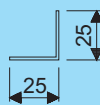
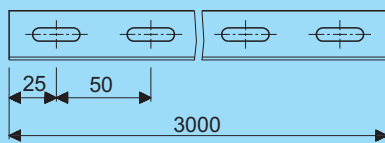

Scheidingsshot
Separation strip

Artikel nr. Product no.			Artikel nr. Product no.	
Senz.v. Mill galv.	Senz.v. gelakt Mill galv./coated	Gewicht Weight	Therm.v. Hot dip galv.	Gewicht Weight
98721.152	98721.158	1,06	98721.153	1,64

levering inclusief:
4 slotbouten M6 x 12
en flensmoeren

supplied complete with:
4 lock screws M6 x 12
and flange nuts

Tray H28

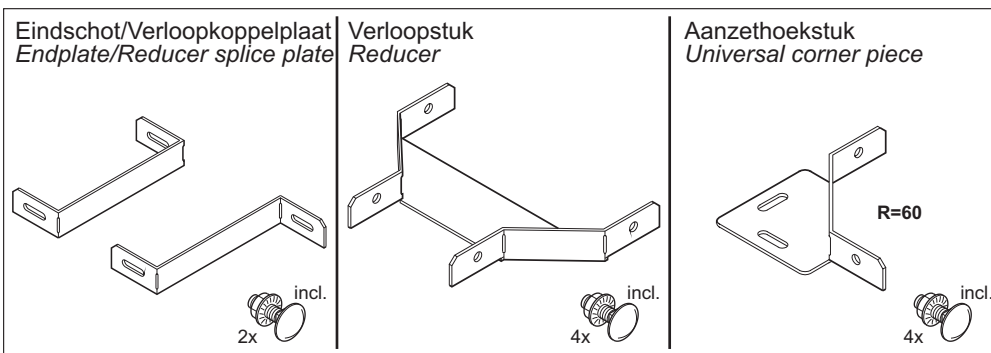

Tray

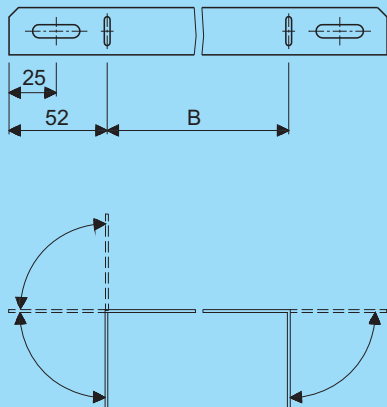

Eindschot/Verloopkoppelplaat Endplate/Reducer splice plate					
B W	Artikel nr. Product no.			Artikel nr. Product no.	
	Sendz.v. Mill galv.	Sendz.v. gelakt Mill galv./coated	Gewicht Weight	Therm.v. Hot dip galv.	Gewicht Weight
25	31170.152	31170.158	0,04	31170.153	0,05
50	31171.152	31171.158	0,04	31171.153	0,05
75	31172.152	31172.158	0,05	31172.153	0,05
100	31173.152	31173.158	0,05	31173.153	0,06
150	31174.152	31174.158	0,06	31174.153	0,07
200	31175.152	31175.158	0,07	31175.153	0,08
250	31176.152	31176.158	0,08	31176.153	0,09
300	31177.152	31177.158	0,09	31177.153	0,10

levering inclusief:
2 slotbouten M6 x 12
en flensmoeren

supplied complete with:
2 lock screws M6 x 12
and flange nuts

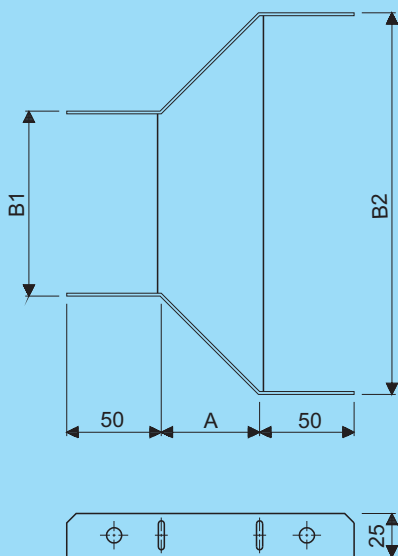

Verloopstuk Reducer						
A	B1-B2	Artikel nr. Product no.			Artikel nr. Product no.	
		Sendz.v. Mill galv.	Sendz.v. gelakt Mill galv./coated	Gewicht Weight	Therm.v. Hot dip galv.	Gewicht Weight
47	50- 75	31191.152	31191.158	0,12	31191.153	0,17
44	50-100	31192.152	31192.158	0,13	31192.153	0,17
34	50-150	31193.152	31193.158	0,14	31193.153	0,19
47	75-100	31194.152	31194.158	0,13	31194.153	0,18
38	75-150	31195.152	31195.158	0,14	31195.153	0,18
63	75-200	31196.152	31196.158	0,17	31196.153	0,22
44	100-150	31197.152	31197.158	0,15	31197.153	0,19
50	100-200	31198.152	31198.158	0,16	31198.153	0,21
75	100-250	31199.152	31199.158	0,21	31199.153	0,26
44	150-200	31200.152	31200.158	0,16	31200.153	0,21
50	150-250	31201.152	31201.158	0,18	31201.153	0,23
75	150-300	31202.152	31202.158	0,24	31202.153	0,29
44	200-250	31203.152	31203.158	0,18	31203.153	0,23
50	200-300	31204.152	31204.158	0,20	31204.153	0,26
44	250-300	31206.152	31206.158	0,19	31206.153	0,25

levering inclusief:
4 slotbouten M6 x 12
en flensmoeren

supplied complete with:
4 lock screws M6 x 12
and flange nuts

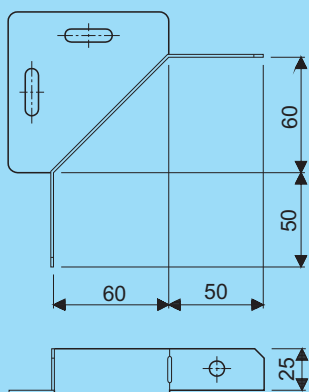

Aanzethoekstuk Universal corner piece				
Artikel nr. Product no.			Artikel nr. Product no.	
Sendz.v. Mill galv.	Sendz.v. gelakt Mill galv./coated	Gewicht Weight	Therm.v. Hot dip galv.	Gewicht Weight
31221.152	31221.158	0,07	31221.153	0,08

levering inclusief:
4 slotbouten M6 x 12
en flensmoeren

supplied complete with:
4 lock screws M6 x 12
and flange nuts

Tray H28

Hoekstuk 45°
Corner piece 45°

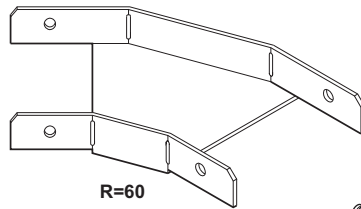

R=60



Hoekstuk 90°
Corner piece 90°

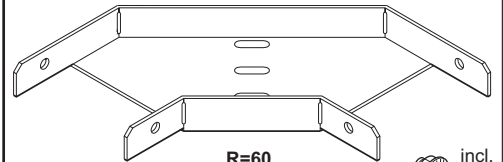

R=60

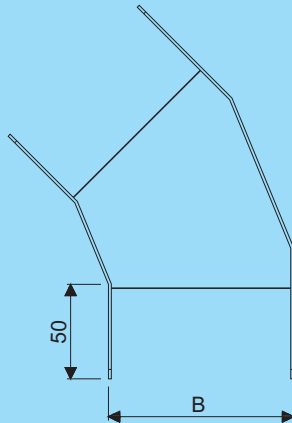

Hoekstuk 45°
Corner piece 45°

B W	Artikel nr. Product no.			Artikel nr. Product no.	
	Senz.v. Mill galv.	Senz.v. gelakt Mill galv./coated	Gewicht Weight	Therm.v. Hot dip galv.	Gewicht Weight
50	31241.152	31241.158	0,07	31241.153	0,08
75	31242.152	31242.158	0,11	31242.153	0,12
100	31243.152	31243.158	0,14	31243.153	0,15
150	31244.152	31244.158	0,21	31244.153	0,22
200	31245.152	31245.158	0,28	31245.153	0,31
250	31246.152	31246.158	0,38	31246.153	0,41
300	31247.152	31247.158	0,50	31247.153	0,55

levering inclusief:
4 slotbouten M6 x 12
en flensmoeren

supplied complete with:
4 lock screws M6 x 12
and flange nuts

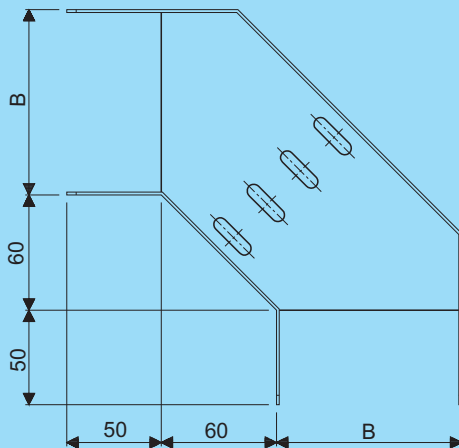

Hoekstuk 90°
Corner piece 90°

B W	Artikel nr. Product no.			Artikel nr. Product no.	
	Senz.v. Mill galv.	Senz.v. gelakt Mill galv./coated	Gewicht Weight	Therm.v. Hot dip galv.	Gewicht Weight
50	31261.152	31261.158	0,16	31261.153	0,17
75	31262.152	31262.158	0,20	31262.153	0,21
100	31263.152	31263.158	0,25	31263.153	0,27
150	31264.152	31264.158	0,29	31264.153	0,35
200	31265.152	31265.158	0,45	31265.153	0,57
250	31266.152	31266.158	0,69	31266.153	0,80
300	31267.152	31267.158	0,88	31267.153	1,04

levering inclusief:
4 slotbouten M6 x 12
en flensmoeren

supplied complete with:
4 lock screws M6 x 12
and flange nuts

Tray H28

Aftakstuk
Branch

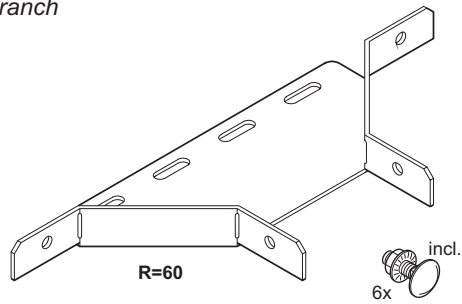

Driewegstuk (gelijkzijdig)
Equal tee piece

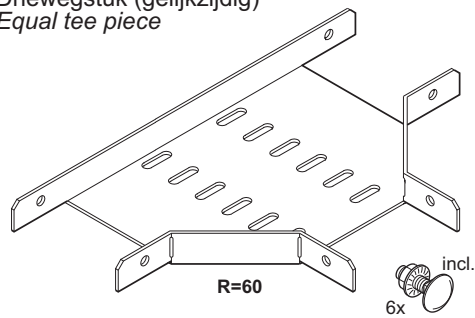

Tray

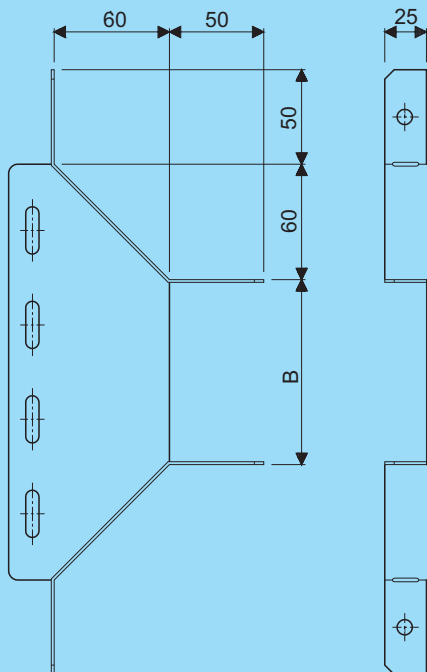

B W	Artikel nr. Product no.			Artikel nr. Product no.	
	Sendz.v. Mill galv.	Sendz.v. gelakt Mill galv./coated	Gewicht Weight	Therm.v. Hot dip galv.	Gewicht Weight
50	31281.152	31281.158	0,17	31281.153	0,18
75	31282.152	31282.158	0,19	31282.153	0,20
100	31283.152	31283.158	0,20	31283.153	0,22
150	31284.152	31284.158	0,24	31284.153	0,25
200	31285.152	31285.158	0,27	31285.153	0,29
250	31286.152	31286.158	0,30	31286.153	0,32
300	31287.152	31287.158	0,33	31287.153	0,36

levering inclusief:
6 slotbouten M6 x 12
en flensmoeren

supplied complete with:
6 lock screws M6 x 12
and flange nuts

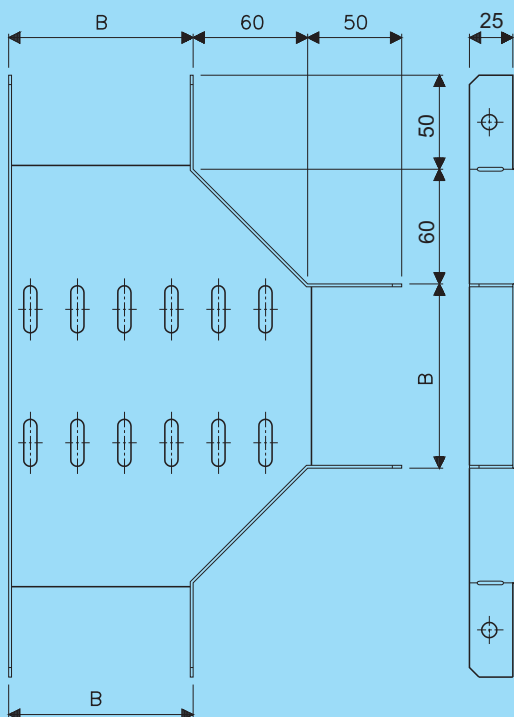

B W	Artikel nr. Product no.			Artikel nr. Product no.	
	Sendz.v. Mill galv.	Sendz.v. gelakt Mill galv./coated	Gewicht Weight	Therm.v. Hot dip galv.	Gewicht Weight
50	31301.152	31301.158	0,27	31301.153	0,29
75	31302.152	31302.158	0,33	31302.153	0,35
100	31303.152	31303.158	0,40	31303.153	0,43
150	31304.152	31304.158	0,57	31304.153	0,62
200	31305.152	31305.158	0,79	31305.153	0,85
250	31306.152	31306.158	1,04	31306.153	1,13
300	31307.152	31307.158	1,34	31307.153	1,45

levering inclusief:
6 slotbouten M6 x 12
en flensmoeren

supplied complete with:
6 lock screws M6 x 12
and flange nuts

Tray H28

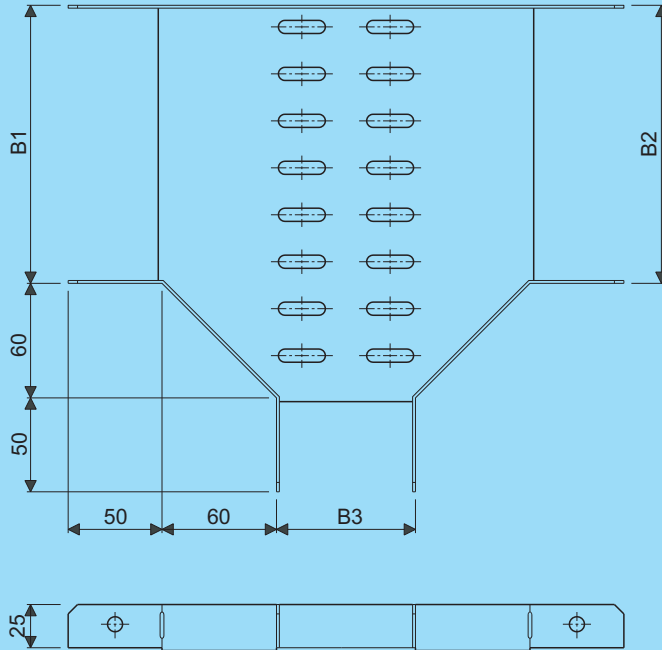
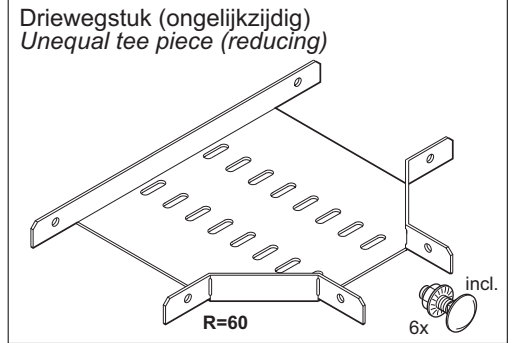

Driewegstuk (ongelijkzijdig) Unequal tee piece (reducing)					
B1-B2-B3	Artikel nr. Product no.			Artikel nr. Product no.	
	Sendz.v. Mill galv.	Sendz.v. gelakt Mill galv./coated	Gewicht Weight	Therm.v. Hot dip galv.	Gewicht Weight
75- 75- 50	31321.152	31321.158	0,30	31321.153	0,32
100-100- 50	31322.152	31322.158	0,33	31322.153	0,35
100-100- 75	31323.152	31323.158	0,36	31323.153	0,39
150-150- 50	31324.152	31324.158	0,39	31324.153	0,42
150-150- 75	31325.152	31325.158	0,43	31325.153	0,47
150-150-100	31326.152	31326.158	0,48	31326.153	0,52
200-200- 50	31327.152	31327.158	0,45	31327.153	0,48
200-200- 75	31328.152	31328.158	0,50	31328.153	0,55
200-200-100	31329.152	31329.158	0,56	31329.153	0,61
200-200-150	31330.152	31330.158	0,67	31330.153	0,73
250-250- 50	31331.152	31331.158	0,51	31331.153	0,55
250-250- 75	31332.152	31332.158	0,58	31332.153	0,62
250-250-100	31333.152	31333.158	0,64	31333.153	0,70
250-250-150	31334.152	31334.158	0,78	31334.153	0,84
250-250-200	31335.152	31335.158	0,91	31335.153	0,99
300-300- 50	31336.152	31336.158	0,57	31336.153	0,60
300-300- 75	31337.152	31337.158	0,65	31337.153	0,70
300-300-100	31338.152	31338.158	0,72	31338.153	0,78
300-300-150	31339.152	31339.158	0,88	31339.153	0,95
300-300-200	31340.152	31340.158	1,03	31340.153	1,12
300-300-250	31341.152	31341.158	1,19	31341.153	1,28

levering inclusief:
6 slotbouten M6 x 12
en flensmoeren
supplied complete with:
6 lock screws M6 x 12
and flange nuts

Tray H28

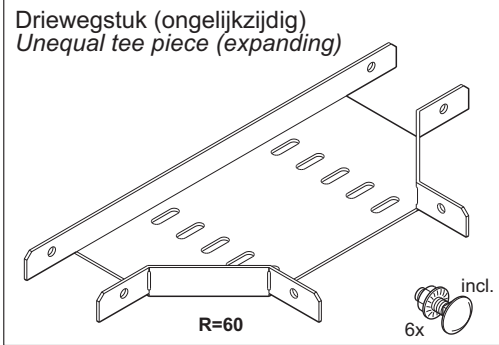

Tray

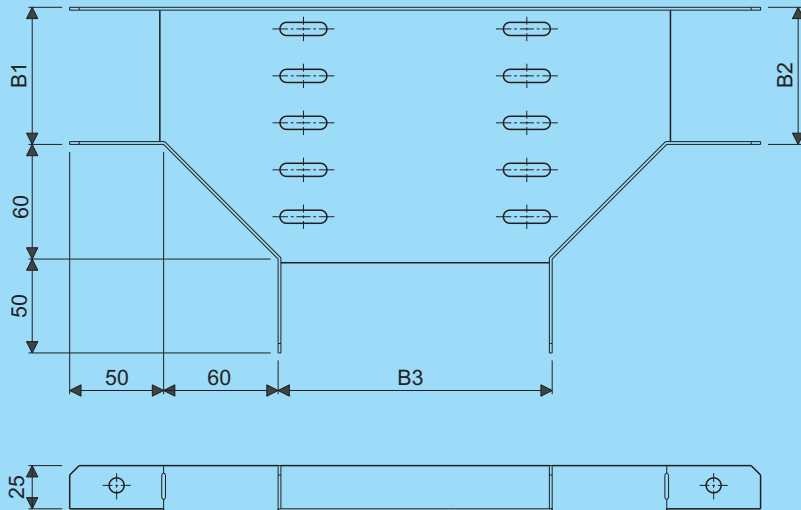

Driewegstuk (ongelijkzijdig) Unequal tee piece (expanding)					
B1-B2-B3	Artikel nr. Product no.			Artikel nr. Product no.	
	Sendz.v. Mill galv.	Sendz.v. gelakt Mill galv./coated	Gewicht Weight	Therm.v. Hot dip galv.	Gewicht Weight
50- 50- 75	31361.152	31361.158	0,29	31361.153	0,31
50- 50-100	31362.152	31362.158	0,32	31362.153	0,34
50- 50-150	31363.152	31363.158	0,37	31363.153	0,40
50- 50-200	31364.152	31364.158	0,43	31364.153	0,46
50- 50-250	31365.152	31365.158	0,48	31365.153	0,52
50- 50-300	31366.152	31366.158	0,53	31366.153	0,57
75- 75-100	31367.152	31367.158	0,36	31367.153	0,38
75- 75-150	31368.152	31368.158	0,42	31368.153	0,45
75- 75-200	31369.152	31369.158	0,48	31369.153	0,52
75- 75-250	31370.152	31370.158	0,55	31370.153	0,59
75- 75-300	31371.152	31371.158	0,61	31371.153	0,66
100-100-150	31372.152	31372.158	0,47	31372.153	0,50
100-100-200	31373.152	31373.158	0,54	31373.153	0,58
100-100-250	31374.152	31374.158	0,61	31374.153	0,66
100-100-300	31375.152	31375.158	0,69	31375.153	0,74
150-150-200	31376.152	31376.158	0,66	31376.153	0,71
150-150-250	31377.152	31377.158	0,75	31377.153	0,82
150-150-300	31378.152	31378.158	0,85	31378.153	0,92
200-200-250	31379.152	31379.158	0,89	31379.153	0,97
200-200-300	31380.152	31380.158	1,01	31380.153	1,09
250-250-300	31381.152	31381.158	1,17	31381.153	1,27

levering inclusief:
6 slotbouten M6 x 12
en flensmoeren
supplied complete with:
6 lock screws M6 x 12
and flange nuts

Tray H28

Vierwegstuk
Cross piece

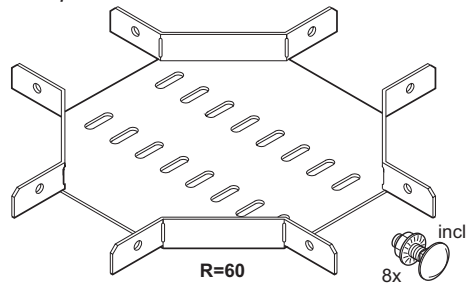

Vierwegstuk (ongelijkzijdig)
Unequal cross piece

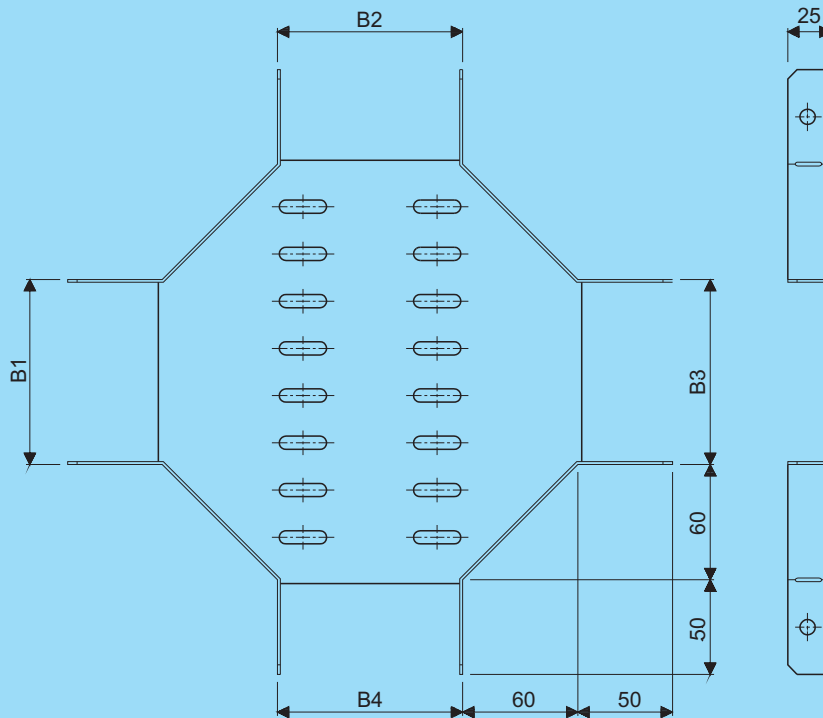
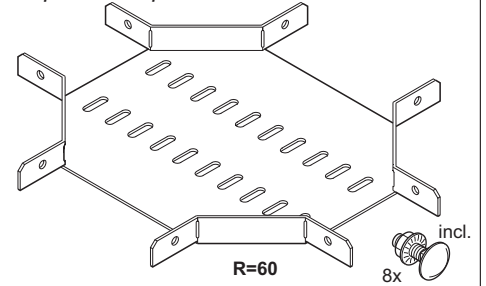

Vierwegstuk Cross piece					
B1-B2-B3-B4	Artikel nr. Product no.			Artikel nr. Product no.	
	Sendz.v. Mill galv.	Sendz.v. gelakt Mill galv./coated	Gewicht Weight	Therm.v. Hot dip galv.	Gewicht Weight
50- 50- 50- 50	31401.152	31401.158	0,37	31401.153	0,39
75- 75- 75- 75	31402.152	31402.158	0,42	31402.153	0,45
100-100-100-100	31403.152	31403.158	0,50	31403.153	0,54
150-150-150-150	31404.152	31404.158	0,69	31404.153	0,75
200-200-200-200	31405.152	31405.158	0,92	31405.153	0,99
250-250-250-250	31406.152	31406.158	1,19	31406.153	1,29
300-300-300-300	31407.152	31407.158	1,50	31407.153	1,62
75- 50- 75- 50	31421.152	31421.158	0,40	31421.153	0,42
100- 50-100- 50	31422.152	31422.158	0,43	31422.153	0,46
100- 75-100- 75	31423.152	31423.158	0,46	31423.153	0,49
150- 50-150- 50	31424.152	31424.158	0,47	31424.153	0,51
150- 75-150- 75	31425.152	31425.158	0,53	31425.153	0,57
150-100-150-100	31426.152	31426.158	0,58	31426.153	0,63
200- 50-200- 50	31427.152	31427.158	0,53	31427.153	0,58
200- 75-200- 75	31428.152	31428.158	0,60	31428.153	0,65
200-100-200-100	31429.152	31429.158	0,66	31429.153	0,72
200-150-200-150	31430.152	31430.158	0,79	31430.153	0,86
250- 50-250- 50	31431.152	31431.158	0,60	31431.153	0,64
250- 75-250- 75	31432.152	31432.158	0,67	31432.153	0,72
250-100-250-100	31433.152	31433.158	0,74	31433.153	0,80
250-150-250-150	31434.152	31434.158	0,89	31434.153	0,97
250-200-250-200	31435.152	31435.158	1,04	31435.153	1,13
300- 50-300- 50	31436.152	31436.158	0,66	31436.153	0,71
300- 75-300- 75	31437.152	31437.158	0,74	31437.153	0,80
300-100-300-100	31438.152	31438.158	0,82	31438.153	0,89
300-150-300-150	31439.152	31439.158	0,99	31439.153	1,08
300-200-300-200	31440.152	31440.158	1,16	31440.153	1,26
300-250-300-250	31441.152	31441.158	1,33	31441.153	1,44

levering inclusief:
8 slotbouten M6 x 12
en flensmoeren

supplied complete with:
8 lock screws M6 x 12
and flange nuts

Tray H28

Stijgstuk 45°
Vertical inner bend 45°

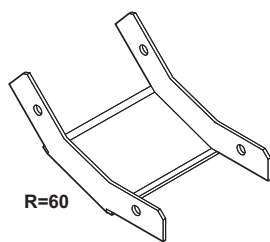

R=60

incl.
4x

Stijgstuk 90°
Vertical inner bend 90°

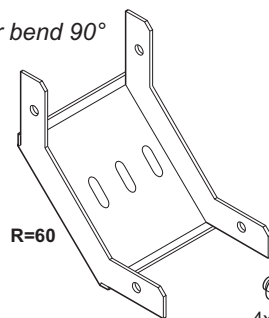

R=60

incl.
4x

Tray

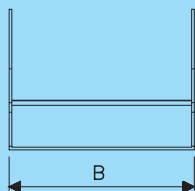
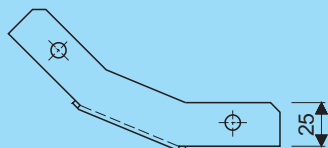

Stijgstuk 45°
Vertical inner bend 45°

B W	Artikel nr. Product no.			Artikel nr. Product no.	
	Sendz.v. Mill galv.	Sendz.v. gelakt Mill galv./coated	Gewicht Weight	Therm.v. Hot dip galv.	Gewicht Weight
50	31461.152	31461.158	0,12	31461.153	0,12
75	31462.152	31462.158	0,13	31462.153	0,14
100	31463.152	31463.158	0,15	31463.153	0,16
150	31464.152	31464.158	0,17	31464.153	0,18
200	31465.152	31465.158	0,19	31465.153	0,21
250	31466.152	31466.158	0,22	31466.153	0,24
300	31467.152	31467.158	0,25	31467.153	0,26

levering inclusief:
4 slotbouten M6 x 12
en flensmoeren

supplied complete with:
4 lock screws M6 x 12
and flange nuts

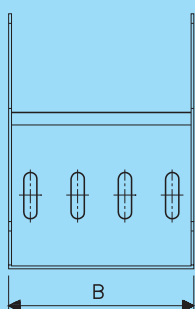
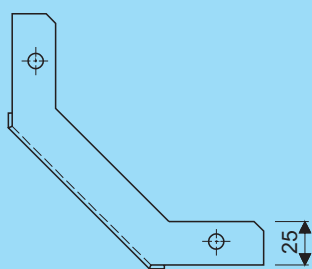

Stijgstuk 90°
Vertical inner bend 90°

B W	Artikel nr. Product no.			Artikel nr. Product no.	
	Sendz.v. Mill galv.	Sendz.v. gelakt Mill galv./coated	Gewicht Weight	Therm.v. Hot dip galv.	Gewicht Weight
50	31481.152	31481.158	0,15	31481.153	0,16
75	31482.152	31482.158	0,17	31482.153	0,18
100	31483.152	31483.158	0,19	31483.153	0,21
150	31484.152	31484.158	0,24	31484.153	0,26
200	31485.152	31485.158	0,29	31485.153	0,31
250	31486.152	31486.158	0,33	31486.153	0,36
300	31487.152	31487.158	0,38	31487.153	0,41

levering inclusief:
4 slotbouten M6 x 12
en flensmoeren

supplied complete with:
4 lock screws M6 x 12
and flange nuts

Tray H28

Vervalstuk 45°
Vertical outer bend 45°

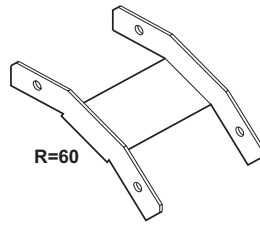

incl.
4x

Vervalstuk 90°
Vertical outer bend 90°

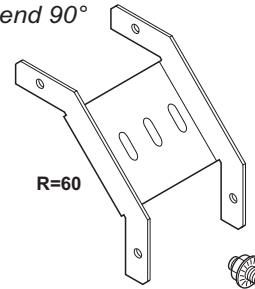

incl.
4x

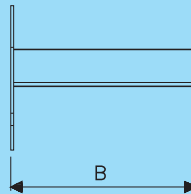
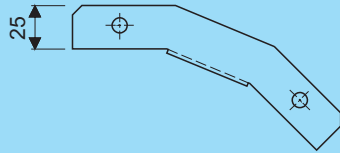

Vervalstuk 45°
Vertical outer bend 45°

B W	Artikel nr. Product no.			Artikel nr. Product no.	
	Senz.v. Mill galv.	Senz.v. gelakt Mill galv./coated	Gewicht Weight	Therm.v. Hot dip galv.	Gewicht Weight
50	31501.152	31501.158	0,11	31501.153	0,11
75	31502.152	31502.158	0,11	31502.153	0,12
100	31503.152	31503.158	0,13	31503.153	0,13
150	31504.152	31504.158	0,15	31504.153	0,15
200	31505.152	31505.158	0,16	31505.153	0,17
250	31506.152	31506.158	0,18	31506.153	0,19
300	31507.152	31507.158	0,20	31507.153	0,21

levering inclusief:
4 slotbouten M6 x 12
en flensmoeren

supplied complete with:
4 lock screws M6 x 12
and flange nuts

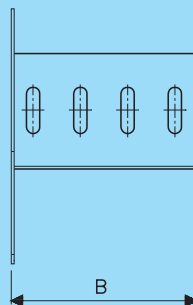
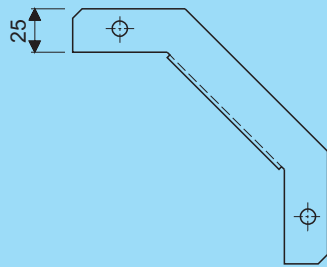

Vervalstuk 90°
Vertical outer bend 90°

B W	Artikel nr. Product no.			Artikel nr. Product no.	
	Senz.v. Mill galv.	Senz.v. gelakt Mill galv./coated	Gewicht Weight	Therm.v. Hot dip galv.	Gewicht Weight
50	31521.152	31521.158	0,13	31521.153	0,14
75	31522.152	31522.158	0,15	31522.153	0,16
100	31523.152	31523.158	0,16	31523.153	0,17
150	31524.152	31524.158	0,19	31524.153	0,21
200	31525.152	31525.158	0,22	31525.153	0,24
250	31526.152	31526.158	0,25	31526.153	0,27
300	31527.152	31527.158	0,28	31527.153	0,31

levering inclusief:
4 slotbouten M6 x 12
en flensmoeren

supplied complete with:
4 lock screws M6 x 12
and flange nuts

Tray H53



Det Norske Veritas (DNV) en Germanischer Lloyd (GL)

Kabelkanaal H53
Cable duct H53

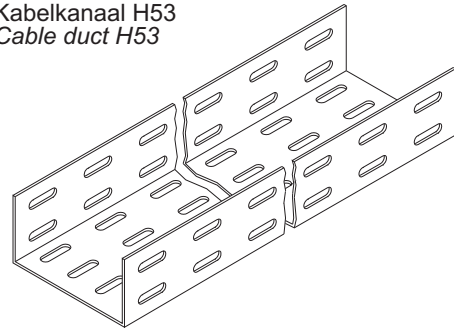

Tray

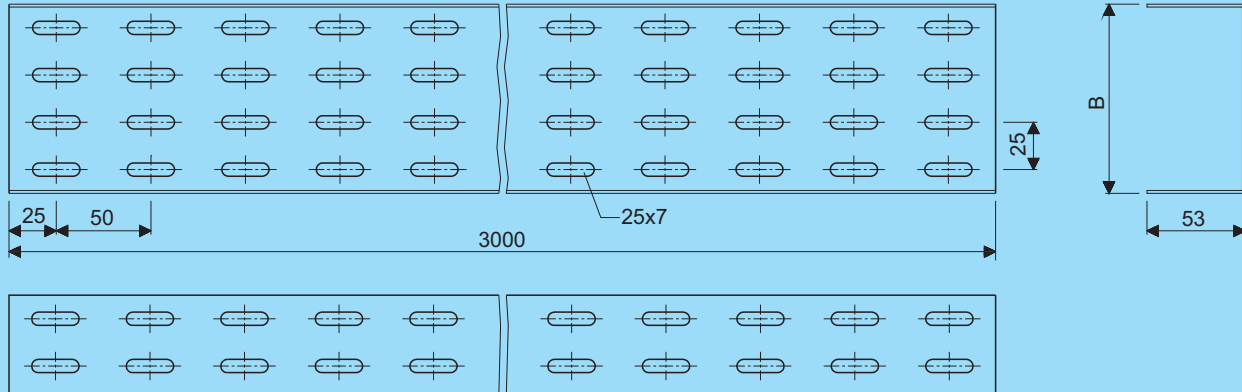

Kabelkanaal - H53
Cable duct - H53

B W	Artikel nr. Product no.			Artikel nr. Product no.	
	Senz.v. Mill galv.	Senz.v. gelakt Mill galv./coated	Gewicht Weight	Therm.v. Hot dip galv.	Gewicht Weight
50	32041.152	32041.158	2,95	32041.153	4,91
75	32042.152	32042.158	3,44	32042.153	5,72
100	32043.152	32043.158	3,94	32043.153	6,54
150	32044.152	32044.158	4,92	32044.153	8,18
200	32045.152	32045.158	5,90	32045.153	9,81
250	32046.152	32046.158	6,89	32046.153	11,45
300	32047.152	32047.158	7,87	32047.153	13,08

Kabelkanaaldeksel
Cable duct cover

B W	Artikel nr. Product no.			Artikel nr. Product no.	
	Senz.v. Mill galv.	Senz.v. gelakt Mill galv./coated	Gewicht Weight	Therm.v. Hot dip galv.	Gewicht Weight
50	35041.142	35041.148	1,70	35041.143	1,85
75	35042.142	35042.148	2,30	35042.143	2,51
100	35043.142	35043.148	2,90	35043.143	3,12
150	35044.142	35044.148	4,10	35044.143	4,47
200	35045.142	35045.148	5,30	35045.143	5,78
250	35046.142	35046.148	6,50	35046.143	7,09
300	35047.142	35047.148	7,70	35047.143	8,40

bestel de benodigde koppelplaten apart,
zij worden niet geleverd bij de kanalen

order splice plates as separate items,
they are not supplied with the cable ducts

Tray H53R



Det Norske Veritas (DNV) en Germanischer Lloyd (GL)

Kabelkanaal H53R
Cable duct H53R

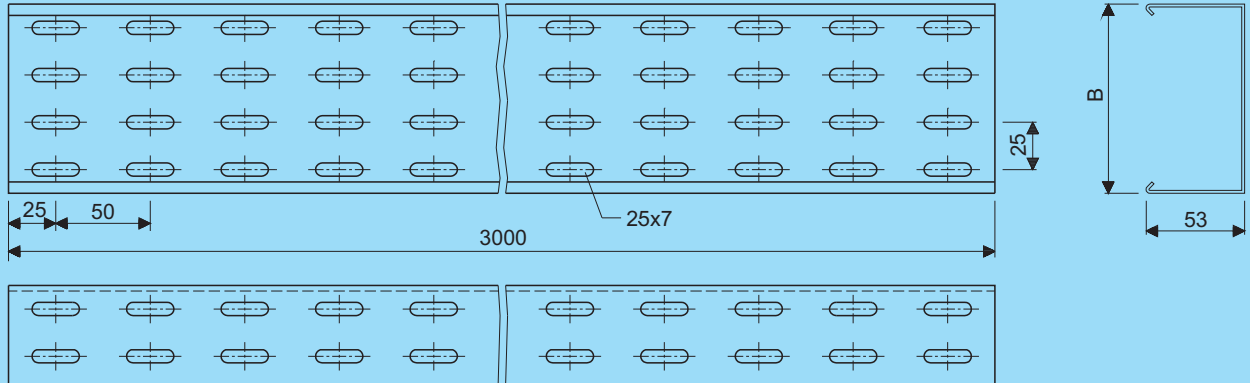
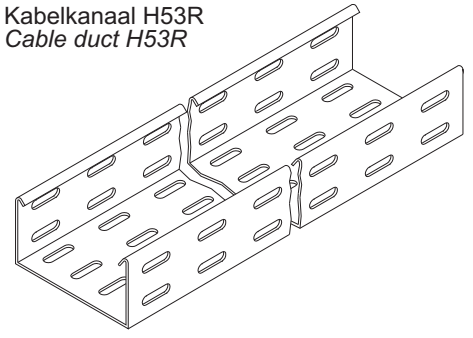

Kabelkanaal - H53R Cable duct - H53R					
B W	Artikel nr. Product no.			Artikel nr. Product no.	
	Senz.v. Mill galv.	Senz.v. gelakt Mill galv./coated	Gewicht Weight	Therm.v. Hot dip galv.	Gewicht Weight
50	32081.152	32081.158	3,28	32081.153	5,45
75	32082.152	32082.158	3,78	32082.153	5,64
100	32083.152	32083.158	4,27	32083.153	7,10
150	32084.152	32084.158	5,26	32084.153	8,72
200	32085.152	32085.158	6,24	32085.153	10,36
250	32086.152	32086.158	7,22	32086.153	11,99
300	32087.152	32087.158	8,21	32087.153	13,63

Kabelkanaaldeksel Cable duct cover					
B W	Artikel nr. Product no.			Artikel nr. Product no.	
	Senz.v. Mill galv.	Senz.v. gelakt Mill galv./coated	Gewicht Weight	Therm.v. Hot dip galv.	Gewicht Weight
50	35041.142	35041.148	1,70	35041.143	1,85
75	35042.142	35042.148	2,30	35042.143	2,51
100	35043.142	35043.148	2,90	35043.143	3,12
150	35044.142	35044.148	4,10	35044.143	4,47
200	35045.142	35045.148	5,30	35045.143	5,78
250	35046.142	35046.148	6,50	35046.143	7,09
300	35047.142	35047.148	7,70	35047.143	8,40

bestel de benodigde koppelplaten apart,
zij worden niet geleverd bij de kanalen
order splice plates as separate items,
they are not supplied with the cable ducts

Dekselveer
Cover spring

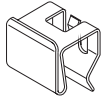

Det Norske Veritas (DNV) en Germanischer Lloyd (GL)

Dekselklem
Cover clamp

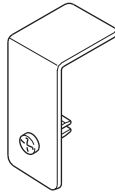

Det Norske Veritas (DNV) en Germanischer Lloyd (GL)

Sluitband met tape
Fastener with tape

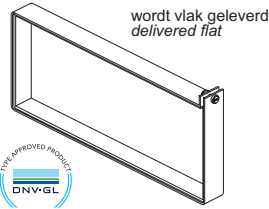

Det Norske Veritas (DNV) en Germanischer Lloyd (GL)

min. 1 st. per meter
min. 1 pc. per meter



Sluitband zonder tape
Fastener without tape

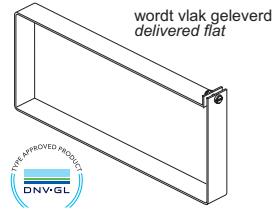

Det Norske Veritas (DNV) en Germanischer Lloyd (GL)

min. 1 st. per meter
min. 1 pc. per meter

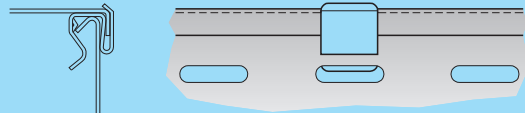
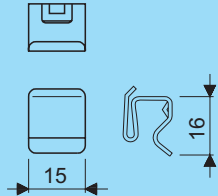

montage-toepassing
mounting application

alleen voor send.z en sendz. gelakt
only for mill galv. and mill galv./coated

bestel de benodigde deksel-
veren apart, zij worden niet
geleverd bij de deksels

kindly order cover springs as
a separate item, they are
not supplied with the covers

Dekselveer Cover spring	
Artikel nr. Product no.	Gewicht Weight
99983.209	0,002

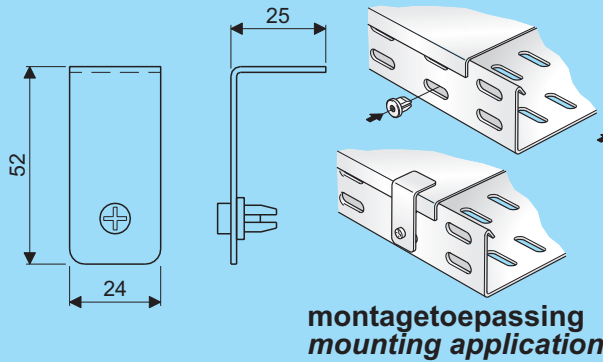

montage-toepassing
mounting application

levering inclusief
nylon plaatmoer en
bolkopschroef
supplied complete
with plate nut and
roundhead screw

bestel de benodigde deksel-
klemmen apart, zij worden
niet geleverd bij de deksels
kindly order cover clamps as
a separate item, they are
not supplied with the covers

Dekselklem Cover clamp				
Artikel nr. Product no.		Artikel nr. Product no.		
Sendz.v. Mill galv.	Sendz.v. gelakt Mill galv./coated	Gewicht Weight	Therm.v. Hot dip galv.	Gewicht Weight
99984.202	99984.208	0,02	99984.203	0,02

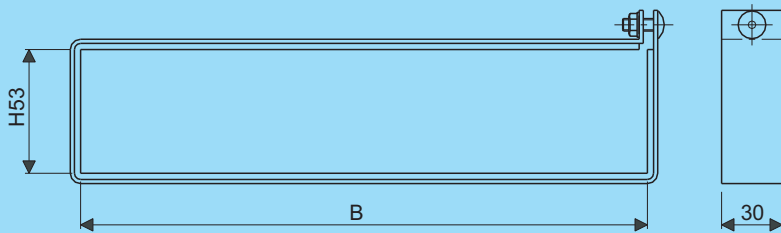

levering inclusief:
1 slotbout M6 x 12
en flensmoer
supplied complete with:
1 lock screw M6 x 12
and flange nut

Sluitband met tape Fastener with tape		
B	Artikel nr. Product no.	Gewicht Weight
	AISI 304	
50	32601.154	0,05
75	32602.154	0,06
100	32603.154	0,08
150	32604.154	0,10
200	32605.154	0,12
250	32606.154	0,15
300	32607.154	0,17

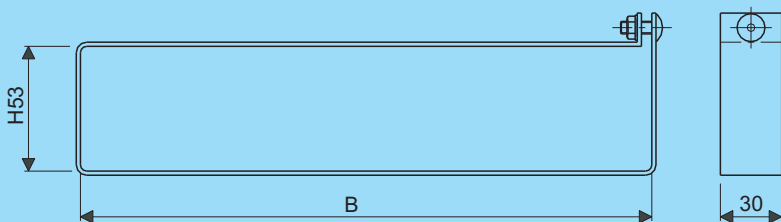

levering inclusief:
1 slotbout M6 x 12
en flensmoer
supplied complete with:
1 lock screw M6 x 12
and flange nut

Sluitband zonder tape Fastener without tape		
B	Artikel nr. Product no.	Gewicht Weight
	AISI 304	
50	32611.154	0,05
75	32612.154	0,06
100	32613.154	0,08
150	32614.154	0,10
200	32615.154	0,12
250	32616.154	0,15
300	32617.154	0,17

Koppelplaat
Splice plate



Del Norske Veritas (DNV) en Germanischer Lloyd (GL)

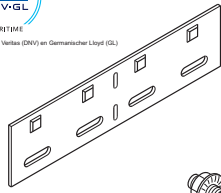

4x

Scharnierende koppelplaat
Hinged splice plate



Del Norske Veritas (DNV) en Germanischer Lloyd (GL)

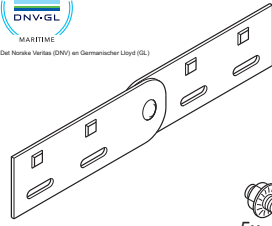

5x

Scheidingsschot
Separation strip



Del Norske Veritas (DNV) en Germanischer Lloyd (GL)

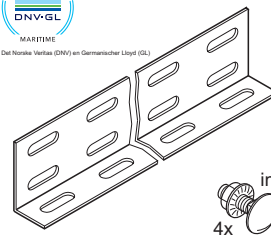

4x

Eindschot/Verloopkoppelplaat
Endplate/Reducer splice plate



Del Norske Veritas (DNV) en Germanischer Lloyd (GL)

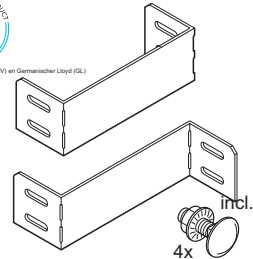

4x

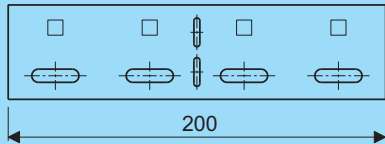

Koppelplaat
Splice plate

Artikel nr. Product no.			Artikel nr. Product no.	
Senz.v. Mill galv.	Senz.v. gelakt Mill galv./coated	Gewicht Weight	Therm.v. Hot dip galv.	Gewicht Weight
32132.152	32132.158	0,11	32132.153	0,15

levering inclusief:
4 slotbouten M6 x12
en flensmoeren

supplied complete with:
4 lock screws M6 x 12
and flange nuts

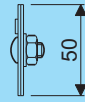
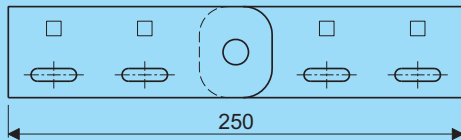

Scharnierende koppelplaat
Hinged splice plate

Artikel nr. Product no.			Artikel nr. Product no.	
Senz.v. Mill galv.	Senz.v. gelakt Mill galv./coated	Gewicht Weight	Therm.v. Hot dip galv.	Gewicht Weight
32151.152	32151.158	0,19	32151.153	0,21

levering inclusief:
5 slotbouten M6 x12
en flensmoeren

supplied complete with:
5 lock screws M6 x 12
and flange nuts

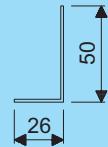
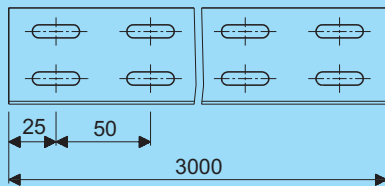
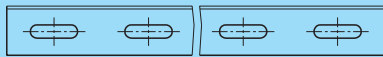

Scheidingsschot
Separation strip

Artikel nr. Product no.			Artikel nr. Product no.	
Senz.v. Mill galv.	Senz.v. gelakt Mill galv./coated	Gewicht Weight	Therm.v. Hot dip galv.	Gewicht Weight
98723.152	98723.158	1,53	98723.153	2,53

levering inclusief:
4 slotbouten M6 x12
en flensmoeren

supplied complete with:
4 lock screws M6 x 12
and flange nuts

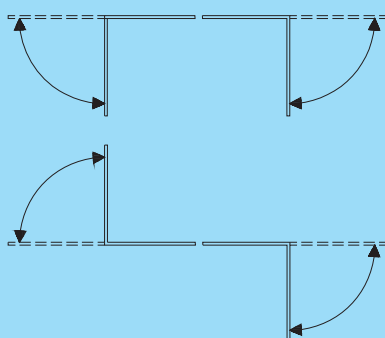
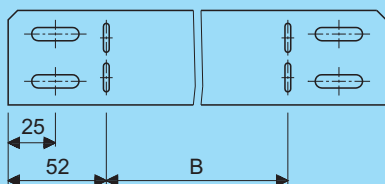

Eindschot/Verloopkoppelplaat
Endplate/Reducer splice plate

B W	Artikel nr. Product no.			Artikel nr. Product no.	
	Senz.v. Mill galv.	Senz.v. gelakt Mill galv./coated	Gewicht Weight	Therm.v. Hot dip galv.	Gewicht Weight
25	32170.152	32170.158	0,11	32170.153	0,11
50	32171.152	32171.158	0,12	32171.153	0,13
75	32172.152	32172.158	0,13	32172.153	0,14
100	32173.152	32173.158	0,14	32173.153	0,15
150	32174.152	32174.158	0,16	32174.153	0,17
200	32175.152	32175.158	0,18	32175.153	0,19
250	32176.152	32176.158	0,20	32176.153	0,21
300	32177.152	32177.158	0,22	32177.153	0,23

levering inclusief:
4 slotbouten M6 x12
en flensmoeren

supplied complete with:
4 lock screws M6 x 12
and flange nuts

Tray H53



Det Norske Veritas (DNV) en Germanischer Lloyd (GL)

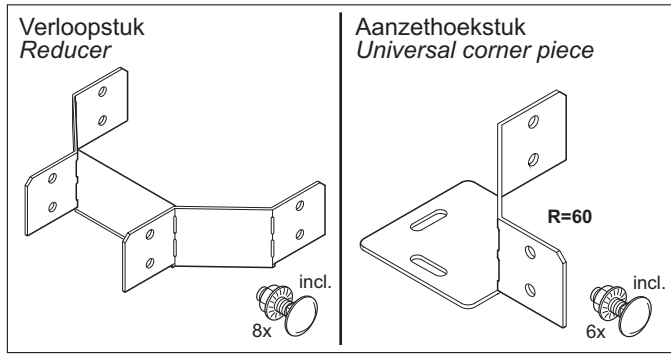

Tray

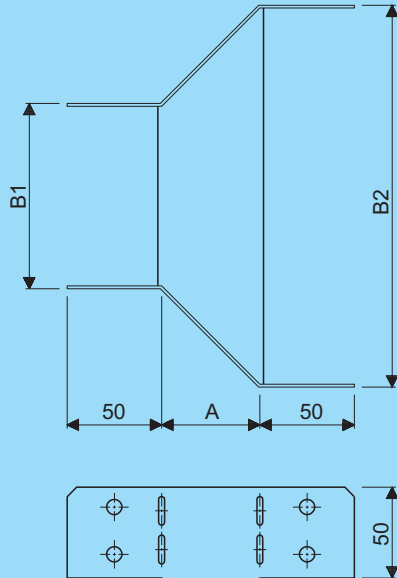

Verloopstuk Reducer						
A	B1-B2	Artikel nr. Product no.			Artikel nr. Product no.	
		Senz.v. Mill galv.	Senz.v. gelakt Mill galv./coated	Gewicht Weight	Therm.v. Hot dip galv.	Gewicht Weight
47	50- 75	32191.152	32191.158	0,23	32191.153	0,31
44	50-100	32192.152	32192.158	0,23	32192.153	0,32
34	50-150	32193.152	32193.158	0,25	32193.153	0,34
47	75-100	32194.152	32194.158	0,24	32194.153	0,32
38	75-150	32195.152	32195.158	0,24	32195.153	0,33
63	75-200	32196.152	32196.158	0,28	32196.153	0,36
44	100-150	32197.152	32197.158	0,25	32197.153	0,34
50	100-200	32198.152	32198.158	0,27	32198.153	0,36
75	100-250	32199.152	32199.158	0,31	32199.153	0,41
44	150-200	32200.152	32200.158	0,27	32200.153	0,36
50	150-250	32201.152	32201.158	0,29	32201.153	0,38
75	150-300	32202.152	32202.158	0,34	32202.153	0,44
44	200-250	32203.152	32203.158	0,29	32203.153	0,38
50	200-300	32204.152	32204.158	0,31	32204.153	0,41
44	250-300	32206.152	32206.158	0,31	32206.153	0,40

Verloopstukdeksel Reducer cover						
A	B1-B2	Artikel nr. Product no.			Artikel nr. Product no.	
		Senz.v. Mill galv.	Senz.v. gelakt Mill galv./coated	Gewicht Weight	Therm.v. Hot dip galv.	Gewicht Weight
47	50- 75	35191.142	35191.148	0,05	35191.143	0,05
44	50-100	35192.142	35192.148	0,05	35192.143	0,06
34	50-150	35193.142	35193.148	0,06	35193.143	0,06
47	75-100	35194.142	35194.148	0,06	35194.143	0,07
38	75-150	35195.142	35195.148	0,07	35195.143	0,07
63	75-200	35196.142	35196.148	0,11	35196.143	0,12
44	100-150	35197.142	35197.148	0,08	35197.143	0,09
50	100-200	35198.142	35198.148	0,11	35198.143	0,12
75	100-250	35199.142	35199.148	0,16	35199.143	0,18
44	150-200	35200.142	35200.148	0,11	35200.143	0,12
50	150-250	35201.142	35201.148	0,14	35201.143	0,15
75	150-300	35202.142	35202.148	0,20	35202.143	0,22
44	200-250	35203.142	35203.148	0,14	35203.143	0,15
50	200-300	35204.142	35204.148	0,17	35204.143	0,18
44	250-300	35206.142	35206.148	0,17	35206.143	0,18

levering inclusief:
8 slotbouten M6 x 12
en flensmoeren

supplied complete with:
8 lock screws M6 x 12
and flange nuts

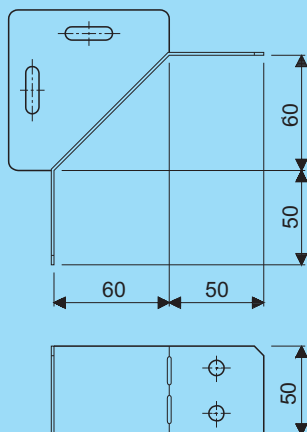

Aanzethoekstuk Universal corner piece				
Artikel nr. Product no.			Artikel nr. Product no.	
Senz.v. Mill galv.	Senz.v. gelakt Mill galv./coated	Gewicht Weight	Therm.v. Hot dip galv.	Gewicht Weight
32221.152	32221.158	0,16	32221.153	0,17

levering inclusief:
4 slotbouten M6 x 12
en flensmoeren

supplied complete with:
4 lock screws M6 x 12
and flange nuts

Tray H53



Det Norske Veritas (DNV) en Germanischer Lloyd (GL)

Hoekstuk 45°
Corner piece 45°

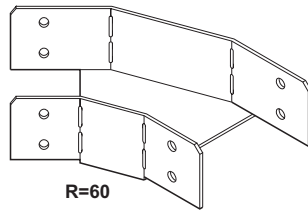

R=60



8x

Hoekstuk 90°
Corner piece 90°

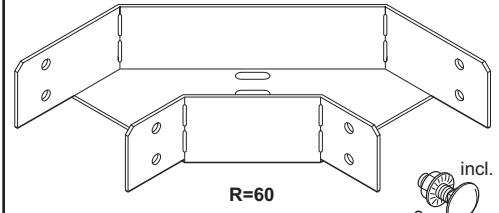

R=60



8x

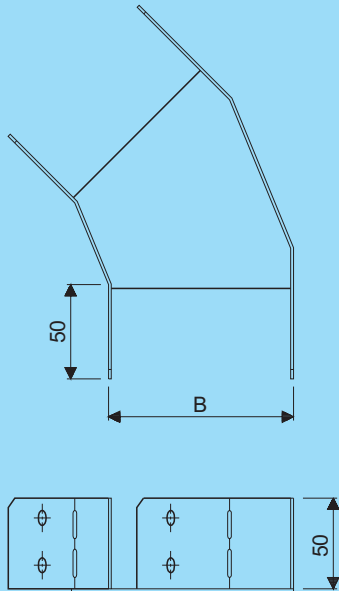

Hoekstuk 45°
Corner piece 45°

B W	Artikel nr. Product no.			Artikel nr. Product no.	
	Senz.v. Mill galv.	Senz.v. gelakt Mill galv./coated	Gewicht Weight	Therm.v. Hot dip galv.	Gewicht Weight
50	32241.152	32241.158	0,24	32241.153	0,25
75	32242.152	32242.158	0,24	32242.153	0,26
100	32243.152	32243.158	0,27	32243.153	0,29
150	32244.152	32244.158	0,34	32244.153	0,37
200	32245.152	32245.158	0,45	32245.153	0,49
250	32246.152	32246.158	0,56	32246.153	0,61
300	32247.152	32247.158	0,68	32247.153	0,73

Hoekstukdeksel 45°
Corner piece cover 45°

B W	Artikel nr. Product no.			Artikel nr. Product no.	
	Senz.v. Mill galv.	Senz.v. gelakt Mill galv./coated	Gewicht Weight	Therm.v. Hot dip galv.	Gewicht Weight
50	35241.142	35241.148	0,05	35241.143	0,05
75	35242.142	35242.148	0,07	35242.143	0,08
100	35243.142	35243.148	0,10	35243.143	0,11
150	35244.142	35244.148	0,17	35244.143	0,19
200	35245.142	35245.148	0,26	35245.143	0,28
250	35246.142	35246.148	0,36	35246.143	0,40
300	35247.142	35247.148	0,48	35247.143	0,52

levering inclusief:
8 slotbouten M6 x 12
en flensmoeren

supplied complete with:
8 lock screws M6 x 12
and flange nuts

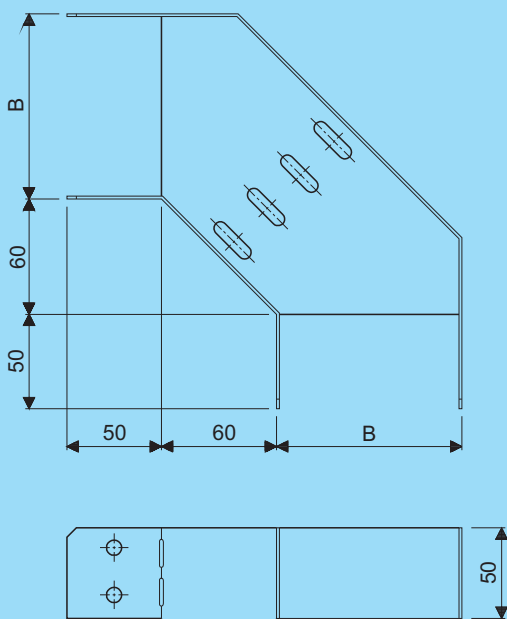

Hoekstuk 90°
Corner piece 90°

B W	Artikel nr. Product no.			Artikel nr. Product no.	
	Senz.v. Mill galv.	Senz.v. gelakt Mill galv./coated	Gewicht Weight	Therm.v. Hot dip galv.	Gewicht Weight
50	32261.152	32261.158	0,28	32261.153	0,30
75	32262.152	32262.158	0,33	32262.153	0,36
100	32263.152	32263.158	0,39	32263.153	0,44
150	32264.152	32264.158	0,59	32264.153	0,64
200	32265.152	32265.158	0,71	32265.153	0,77
250	32266.152	32266.158	0,93	32266.153	1,00
300	32267.152	32267.158	1,17	32267.153	1,27

Hoekstukdeksel 90°
Corner piece cover 90°

B W	Artikel nr. Product no.			Artikel nr. Product no.	
	Senz.v. Mill galv.	Senz.v. gelakt Mill galv./coated	Gewicht Weight	Therm.v. Hot dip galv.	Gewicht Weight
50	35261.142	35261.148	0,08	35261.143	0,08
75	35262.142	35262.148	0,12	35262.143	0,13
100	35263.142	35263.148	0,18	35263.143	0,20
150	35264.142	35264.148	0,32	35264.143	0,35
200	35265.142	35265.148	0,50	35265.143	0,54
250	35266.142	35266.148	0,67	35266.143	0,73
300	35267.142	35267.148	0,87	35267.143	0,97

levering inclusief:
8 slotbouten M6 x 12
en flensmoeren

supplied complete with:
8 lock screws M6 x 12
and flange nuts

Tray H53



Det Norske Veritas (DNV) en Germanischer Lloyd (GL)

Aftakstuk
Branch

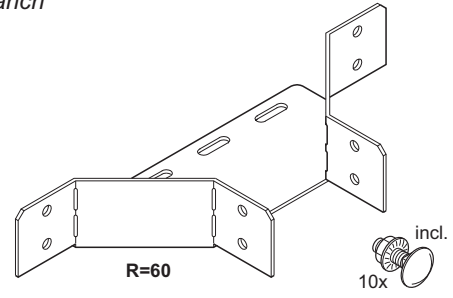

Tray

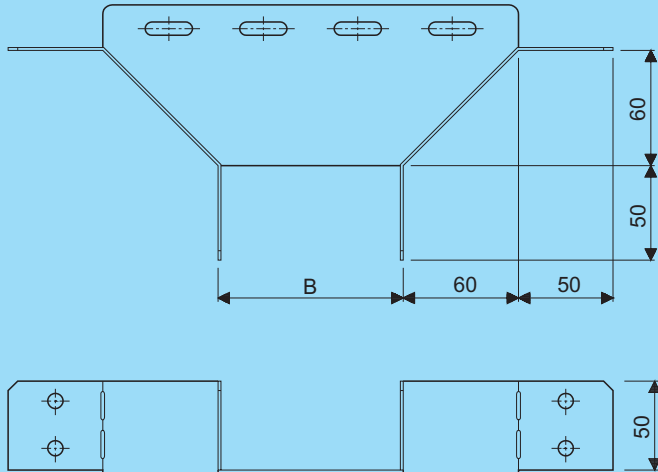

Aftakstuk Branch					
B W	Artikel nr. Product no.			Artikel nr. Product no.	
	Sendz.v. Mill galv.	Sendz.v. gelakt Mill galv./coated	Gewicht Weight	Therm.v. Hot dip galv.	Gewicht Weight
50	32281.152	32281.158	0,31	32281.153	0,33
75	32282.152	32282.158	0,32	32282.153	0,34
100	32283.152	32283.158	0,34	32283.153	0,37
150	32284.152	32284.158	0,37	32284.153	0,40
200	32285.152	32285.158	0,41	32285.153	0,44
250	32286.152	32286.158	0,44	32286.153	0,47
300	32287.152	32287.158	0,47	32287.153	0,51

Aftakstukdeksel Branch cover					
B W	Artikel nr. Product no.			Artikel nr. Product no.	
	Sendz.v. Mill galv.	Sendz.v. gelakt Mill galv./coated	Gewicht Weight	Therm.v. Hot dip galv.	Gewicht Weight
50	35281.142	35281.148	0,09	35281.143	0,09
75	35282.142	35282.148	0,11	35282.143	0,12
100	35283.142	35283.148	0,12	35283.143	0,13
150	35284.142	35284.148	0,18	35284.143	0,19
200	35285.142	35285.148	0,19	35285.143	0,21
250	35286.142	35286.148	0,24	35286.143	0,26
300	35287.142	35287.148	0,27	35287.143	0,29

levering inclusief:
8 slotbouten M6 x 12
en flensmoeren

supplied complete with:
8 lock screws M6 x 12
and flange nuts

Tray H53



Det Norske Veritas (DNV) en Germanischer Lloyd (GL)

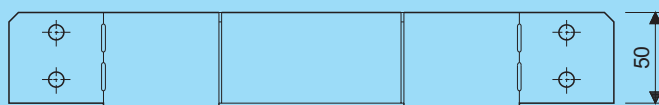
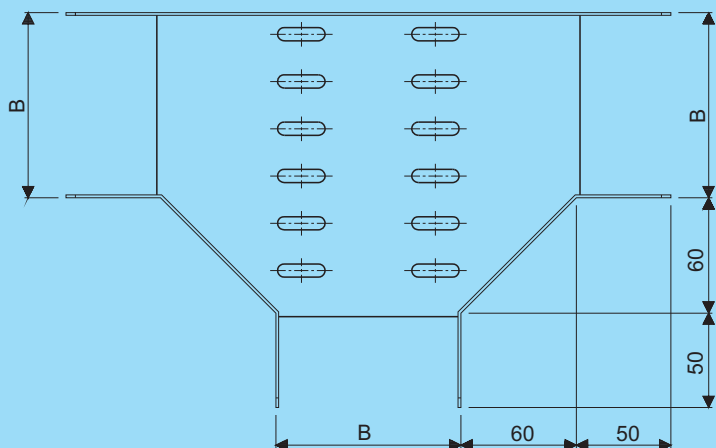
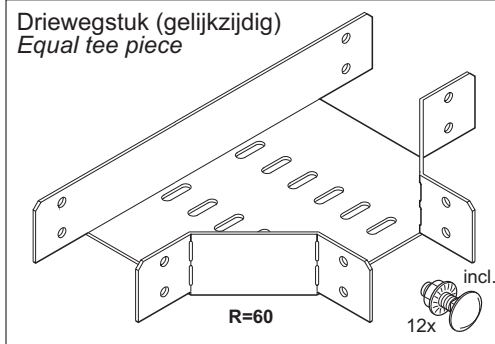

Driewegstuk (gelijkzijdig) Equal tee piece					
B W	Artikel nr. Product no.			Artikel nr. Product no.	
	Sendz.v. Mill galv.	Sendz.v. gelakt Mill galv./coated	Gewicht Weight	Therm.v. Hot dip galv.	Gewicht Weight
50	32301.152	32301.158	0,44	32301.153	0,47
75	32302.152	32302.158	0,48	32302.153	0,51
100	32303.152	32303.158	0,58	32303.153	0,61
150	32304.152	32304.158	0,76	32304.153	0,82
200	32305.152	32305.158	0,98	32305.153	1,06
250	32306.152	32306.158	1,25	32306.153	1,35
300	32307.152	32307.158	1,55	32307.153	1,68

Driewegstukdeksel (gelijkzijdig) Equal tee piece cover					
B W	Artikel nr. Product no.			Artikel nr. Product no.	
	Sendz.v. Mill galv.	Sendz.v. gelakt Mill galv./coated	Gewicht Weight	Therm.v. Hot dip galv.	Gewicht Weight
50	35301.142	35301.148	0,16	35301.143	0,18
75	35302.142	35302.148	0,24	35302.143	0,26
100	35303.142	35303.148	0,31	35303.143	0,34
150	35304.142	35304.148	0,50	35304.143	0,55
200	35305.142	35305.148	0,74	35305.143	0,81
250	35306.142	35306.148	1,02	35306.143	1,11
300	35307.142	35307.148	1,33	35307.143	1,45

levering inclusief:
12 slotbouten M6 x 12
en flensmoeren

supplied complete with:
12 lock screws M6 x 12
and flange nuts

Tray H53



Det Norske Veritas (DNV) en Germanischer Lloyd (GL)

Driewegstuk (ongelijkzijdig)
Unequal tee piece (reducing)

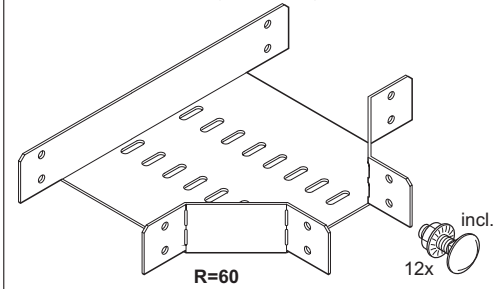

Tray

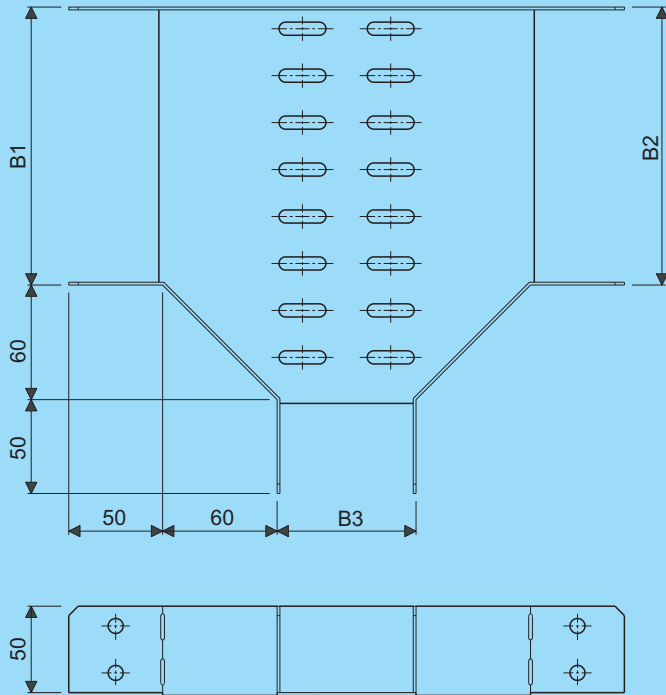

Driewegstuk (ongelijkzijdig) Unequal tee piece (reducing)						Driewegstukdeksel (ongelijkzijdig) Unequal tee piece cover (reducing)						
B1-B2-B3	Artikel nr. Product no.			Artikel nr. Product no.			Artikel nr. Product no.			Artikel nr. Product no.		
	Senz.v. Mill galv.	Senz.v. gelakt Mill galv./coated	Gewicht Weight	Therm.v. Hot dip galv.	Gewicht Weight	Senz.v. Mill galv.	Senz.v. gelakt Mill galv./coated	Gewicht Weight	Therm.v. Hot dip galv.	Gewicht Weight		
75- 75- 50	32321.152	32321.158	0,47	32321.153	0,50	35321.142	35321.148	0,20	35321.143	0,22		
100-100- 50	32322.152	32322.158	0,49	32322.153	0,53	35322.142	35322.148	0,24	35322.143	0,27		
100-100- 75	32323.152	32323.158	0,54	32323.153	0,57	35323.142	35323.148	0,27	35323.143	0,29		
150-150- 50	32324.152	32324.158	0,55	32324.153	0,59	35324.142	35324.148	0,32	35324.143	0,35		
150-150- 75	32325.152	32325.158	0,61	32325.153	0,65	35325.142	35325.148	0,37	35325.143	0,40		
150-150-100	32326.152	32326.158	0,66	32326.153	0,71	35326.142	35326.148	0,42	35326.143	0,45		
200-200- 50	32327.152	32327.158	0,62	32327.153	0,66	35327.142	35327.148	0,40	35327.143	0,44		
200-200- 75	32328.152	32328.158	0,68	32328.153	0,73	35328.142	35328.148	0,46	35328.143	0,50		
200-200-100	32329.152	32329.158	0,74	32329.153	0,79	35329.142	35329.148	0,52	35329.143	0,56		
200-200-150	32330.152	32330.158	0,86	32330.153	0,93	35330.142	35330.148	0,63	35330.143	0,69		
250-250- 50	32331.152	32331.158	0,68	32331.153	0,73	35331.142	35331.148	0,48	35331.143	0,53		
250-250- 75	32332.152	32332.158	0,75	32332.153	0,80	35332.142	35332.148	0,55	35332.143	0,60		
250-250-100	32333.152	32333.158	0,82	32333.153	0,88	35333.142	35333.148	0,62	35333.143	0,67		
250-250-150	32334.152	32334.158	0,96	32334.153	1,04	35334.142	35334.148	0,75	35334.143	0,82		
250-250-200	32335.152	32335.158	1,11	32335.153	1,20	35335.142	35335.148	0,88	35335.143	0,96		
300-300- 50	32336.152	32336.158	0,74	32336.153	0,79	35336.142	35336.148	0,56	35336.143	0,61		
300-300- 75	32337.152	32337.158	0,82	32337.153	0,88	35337.142	35337.148	0,64	35337.143	0,70		
300-300-100	32338.152	32338.158	0,90	32338.153	0,97	35338.142	35338.148	0,72	35338.143	0,78		
300-300-150	32339.152	32339.158	1,06	32339.153	1,15	35339.142	35339.148	0,87	35339.143	0,95		
300-300-200	32340.152	32340.158	1,23	32340.153	1,33	35340.142	35340.148	1,02	35340.143	1,12		
300-300-250	32341.152	32341.158	1,39	32341.153	1,50	35341.142	35341.148	1,18	35341.143	1,28		

levering inclusief:
12 slotbouten M6 x 12
en flensmoeren

supplied complete with:
12 lock screws M6 x 12
and flange nuts

Tray H53



Det Norske Veritas (DNV) en Germanischer Lloyd (GL)

Driewegstuk (ongelijkzijdig)
Unequal tee piece (expanding)

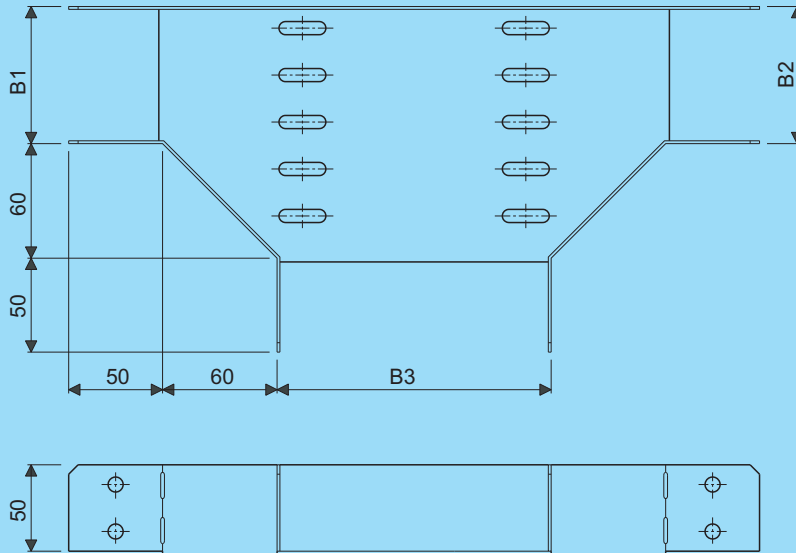
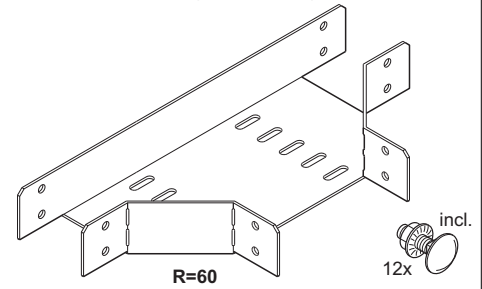

Driewegstuk (ongelijkzijdig) Unequal tee piece (expanding)						Driewegstuk (ongelijkzijdig) Unequal tee piece (expanding)						
B1-B2-B3	Artikel nr. Product no.			Artikel nr. Product no.			Artikel nr. Product no.			Artikel nr. Product no.		
	Sendz.v. Mill galv.	Sendz.v. gelakt Mill galv./coated	Gewicht Weight	Therm.v. Hot dip galv.	Gewicht Weight	Sendz.v. Mill galv.	Sendz.v. gelakt Mill galv./coated	Gewicht Weight	Therm.v. Hot dip galv.	Gewicht Weight		
50- 50- 75	32361.152	32361.158	0,47	32361.153	0,50	35361.142	35361.148	0,19	35361.143	0,21		
50- 50-100	32362.152	32362.158	0,50	32362.153	0,54	35362.142	35362.148	0,22	35362.143	0,24		
50- 50-150	32363.152	32363.158	0,56	32363.153	0,61	35363.142	35363.148	0,27	35363.143	0,30		
50- 50-200	32364.152	32364.158	0,63	32364.153	0,67	35364.142	35364.148	0,32	35364.143	0,35		
50- 50-250	32365.152	32365.158	0,69	32365.153	0,74	35365.142	35365.148	0,38	35365.143	0,41		
50- 50-300	32366.152	32366.158	0,75	32366.153	0,81	35366.142	35366.148	0,43	35366.143	0,47		
75- 75-100	32367.152	32367.158	0,54	32367.153	0,58	35367.142	35367.148	0,27	35367.143	0,29		
75- 75-150	32368.152	32368.158	0,61	32368.153	0,66	35368.142	35368.148	0,33	35368.143	0,36		
75- 75-200	32369.152	32369.158	0,69	32369.153	0,74	35369.142	35369.148	0,39	35369.143	0,43		
75- 75-250	32370.152	32370.158	0,76	32370.153	0,82	35370.142	35370.148	0,46	35370.143	0,50		
75- 75-300	32371.152	32371.158	0,83	32371.153	0,90	35371.142	35371.148	0,52	35371.143	0,57		
100-100-150	32372.152	32372.158	0,66	32372.153	0,71	35372.142	35372.148	0,39	35372.143	0,43		
100-100-200	32373.152	32373.158	0,74	32373.153	0,80	35373.142	35373.148	0,46	35373.143	0,51		
100-100-250	32374.152	32374.158	0,83	32374.153	0,89	35374.142	35374.148	0,54	35374.143	0,59		
100-100-300	32375.152	32375.158	0,91	32375.153	0,98	35375.142	35375.148	0,61	35375.143	0,67		
150-150-200	32376.152	32376.158	0,86	32376.153	0,93	35376.142	35376.148	0,60	35376.143	0,66		
150-150-250	32377.152	32377.158	0,97	32377.153	1,04	35377.142	35377.148	0,70	35377.143	0,76		
150-150-300	32378.152	32378.158	1,07	32378.153	1,16	35378.142	35378.148	0,79	35378.143	0,86		
200-200-250	32379.152	32379.158	1,11	32379.153	1,20	35379.142	35379.148	0,86	35379.143	0,94		
200-200-300	32380.152	32380.158	1,23	32380.153	1,33	35380.142	35380.148	0,97	35380.143	1,06		
250-250-300	32381.152	32381.158	1,39	32381.153	1,51	35381.142	35381.148	1,15	35381.143	1,26		

supplied complete with:
12 lock screws M6 x 12
and flange nuts

levering inclusief:
12 slotbouten M6 x 12
en flensmoeren

Tray H53



Det Norske Veritas (DNV) en Germanischer Lloyd (GL)

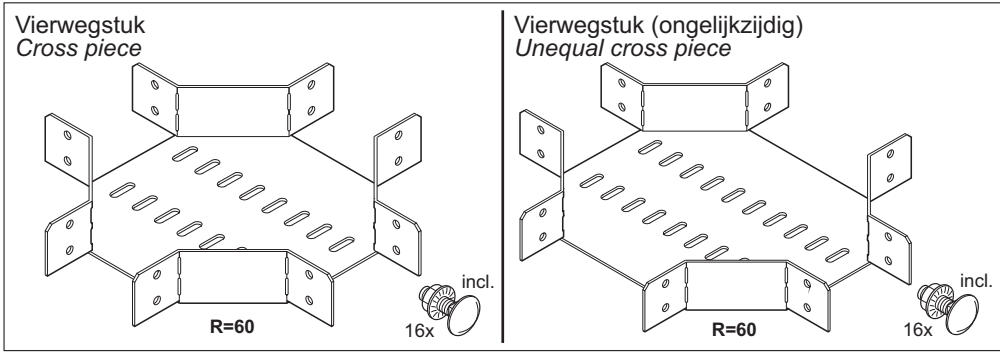

Tray

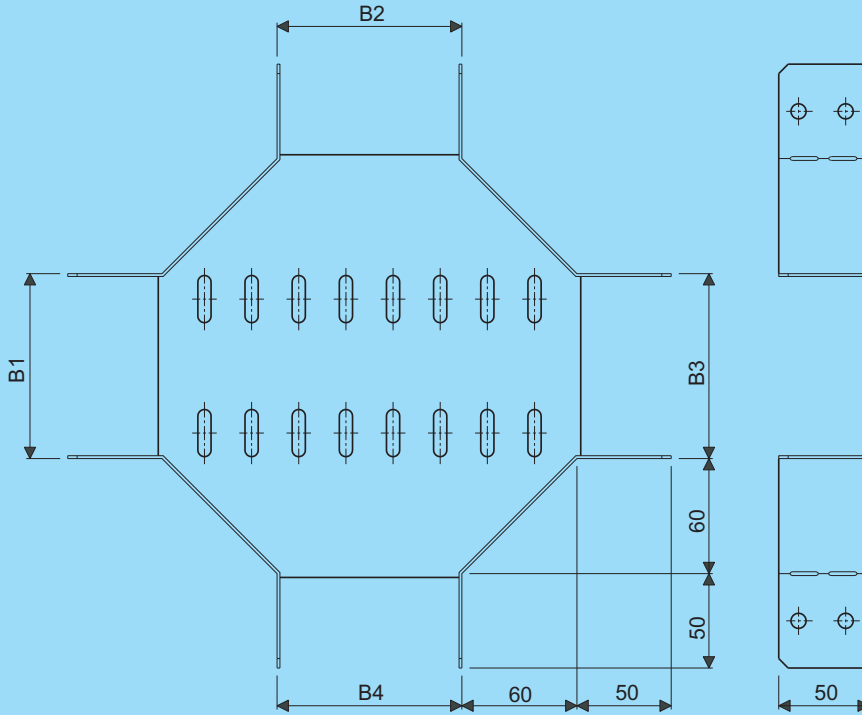

Vierwegstuk Cross piece						Vierwegstukdeksel Cross piece cover				
B1-B2-B3-B4	Artikel nr. Product no.			Artikel nr. Product no.		Artikel nr. Product no.			Artikel nr. Product no.	
	Senz.v. Mill galv.	Senz.v. gelakt Mill galv./coated	Gewicht Weight	Therm.v. Hot dip galv.	Gewicht Weight	Senz.v. Mill galv.	Senz.v. gelakt Mill galv./coated	Gewicht Weight	Therm.v. Hot dip galv.	Gewicht Weight
50- 50- 50- 50	32401.152	32401.158	0,56	32401.153	0,60	35401.142	35401.148	0,22	35401.143	0,24
75- 75- 75- 75	32402.152	32402.158	0,63	32402.153	0,67	35402.142	35402.148	0,29	35402.143	0,31
100-100-100-100	32403.152	32403.158	0,71	32403.153	0,76	35403.142	35403.148	0,40	35403.143	0,44
150-150-150-150	32404.152	32404.158	0,90	32404.153	0,97	35404.142	35404.148	0,58	35404.143	0,64
200-200-200-200	32405.152	32405.158	1,13	32405.153	1,22	35405.142	35405.148	0,88	35405.143	0,96
250-250-250-250	32406.152	32406.158	1,40	32406.153	1,51	35406.142	35406.148	1,18	35406.143	1,29
300-300-300-300	32407.152	32407.158	1,71	32407.153	1,85	35407.142	35407.148	1,52	35407.143	1,66
75- 50- 75- 50	32421.152	32421.158	0,59	32421.153	0,63	35421.142	35421.148	0,26	35421.143	0,28
100- 50-100- 50	32422.152	32422.158	0,63	32422.153	0,67	35422.142	35422.148	0,30	35422.143	0,33
100- 75-100- 75	32423.152	32423.158	0,67	32423.153	0,71	35423.142	35423.148	0,35	35423.143	0,38
150- 50-150- 50	32424.152	32424.158	0,68	32424.153	0,73	35424.142	35424.148	0,38	35424.143	0,41
150- 75-150- 75	32425.152	32425.158	0,74	32425.153	0,79	35425.142	35425.148	0,44	35425.143	0,48
150-100-150-100	32426.152	32426.158	0,79	32426.153	0,85	35426.142	35426.148	0,50	35426.143	0,55
200- 50-200- 50	32427.152	32427.158	0,74	32427.153	0,80	35427.142	35427.148	0,46	35427.143	0,50
200- 75-200- 75	32428.152	32428.158	0,81	32428.153	0,87	35428.142	35428.148	0,53	35428.143	0,58
200-100-200-100	32429.152	32429.158	0,87	32429.153	0,94	35429.142	35429.148	0,60	35429.143	0,65
200-150-200-150	32430.152	32430.158	1,00	32430.153	1,08	35430.142	35430.148	0,74	35430.143	0,81
250- 50-250- 50	32431.152	32431.158	0,80	32431.153	0,86	35431.142	35431.148	0,54	35431.143	0,59
250- 75-250- 75	32432.152	32432.158	0,88	32432.153	0,94	35432.142	35432.148	0,62	35432.143	0,68
250-100-250-100	32433.152	32433.158	0,95	32433.153	1,03	35433.142	35433.148	0,70	35433.143	0,76
250-150-250-150	32434.152	32434.158	1,10	32434.153	1,19	35434.142	35434.148	0,86	35434.143	0,94
250-200-250-200	32435.152	32435.158	1,25	32435.153	1,35	35435.142	35435.148	1,02	35435.143	1,11
300- 50-300- 50	32436.152	32436.158	0,87	32436.153	0,94	35436.142	35436.148	0,62	35436.143	0,68
300- 75-300- 75	32437.152	32437.158	0,95	32437.153	1,02	35437.142	35437.148	0,71	35437.143	0,77
300-100-300-100	32438.152	32438.158	1,03	32438.153	1,11	35438.142	35438.148	0,80	35438.143	0,87
300-150-300-150	32439.152	32439.158	1,20	32439.153	1,30	35439.142	35439.148	0,98	35439.143	1,07
300-200-300-200	32440.152	32440.158	1,37	32440.153	1,48	35440.142	35440.148	1,16	35440.143	1,26
300-250-300-250	32441.152	32441.158	1,54	32441.153	1,66	35441.142	35441.148	1,34	35441.143	1,46

levering inclusief:
16 slotbouten M6 x 12
en flensmoeren

supplied complete with:
16 lock screws M6 x 12
and flange nuts

Tray H53



Det Norske Veritas (DNV) en Germanischer Lloyd (GL)

Stijgstuk 45°
Vertical inner bend 45°

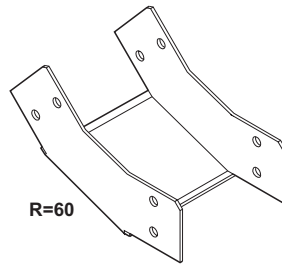

R=60



Stijgstuk 90°
Vertical inner bend 90°

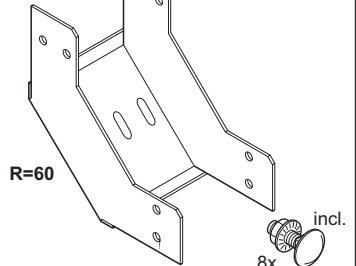

R=60

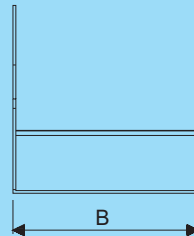
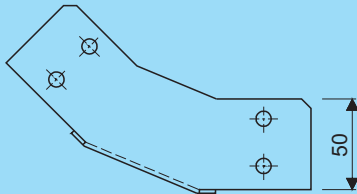

B W	Artikel nr. Product no.			Artikel nr. Product no.	
	Senz.v. Mill galv.	Senz.v. gelakt Mill galv./coated	Gewicht Weight	Therm.v. Hot dip galv.	Gewicht Weight
50	32461.152	32461.158	0,23	32461.153	0,24
75	32462.152	32462.158	0,24	32462.153	0,25
100	32463.152	32463.158	0,26	32463.153	0,27
150	32464.152	32464.158	0,29	32464.153	0,31
200	32465.152	32465.158	0,33	32465.153	0,35
250	32466.152	32466.158	0,37	32466.153	0,39
300	32467.152	32467.158	0,40	32467.153	0,43

Stijgstukdeksel 45° Vertical inner bend cover 45°					
B W	Artikel nr. Product no.			Artikel nr. Product no.	
	Senz.v. Mill galv.	Senz.v. gelakt Mill galv./coated	Gewicht Weight	Therm.v. Hot dip galv.	Gewicht Weight
50	35461.142	35461.148	0,04	35461.143	0,04
75	35462.142	35462.148	0,05	35462.143	0,06
100	35463.142	35463.148	0,07	35463.143	0,07
150	35464.142	35464.148	0,10	35464.143	0,11
200	35465.142	35465.148	0,13	35465.143	0,14
250	35466.142	35466.148	0,15	35466.143	0,17
300	35467.142	35467.148	0,19	35467.143	0,21

levering inclusief:
8 slotbouten M6 x 12
en flensmoeren

supplied complete with:
8 lock screws M6 x 12
and flange nuts

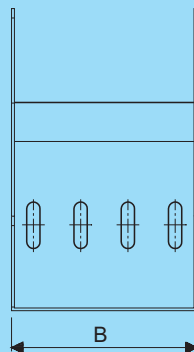
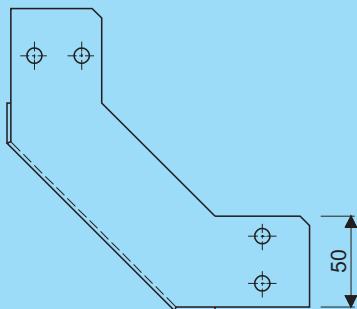

B W	Artikel nr. Product no.			Artikel nr. Product no.	
	Senz.v. Mill galv.	Senz.v. gelakt Mill galv./coated	Gewicht Weight	Therm.v. Hot dip galv.	Gewicht Weight
50	32481.152	32481.158	0,29	32481.153	0,32
75	32482.152	32482.158	0,33	32482.153	0,35
100	32483.152	32483.158	0,36	32483.153	0,38
150	32484.152	32484.158	0,42	32484.153	0,45
200	32485.152	32485.158	0,48	32485.153	0,52
250	32486.152	32486.158	0,55	32486.153	0,59
300	32487.152	32487.158	0,61	32487.153	0,66

Stijgstukdeksel 90° Vertical inner bend cover 90°					
B W	Artikel nr. Product no.			Artikel nr. Product no.	
	Senz.v. Mill galv.	Senz.v. gelakt Mill galv./coated	Gewicht Weight	Therm.v. Hot dip galv.	Gewicht Weight
50	35481.142	35481.148	0,06	35481.143	0,06
75	35482.142	35482.148	0,08	35482.143	0,09
100	35483.142	35483.148	0,10	35483.143	0,11
150	35484.142	35484.148	0,15	35484.143	0,16
200	35485.142	35485.148	0,20	35485.143	0,21
250	35486.142	35486.148	0,23	35486.143	0,25
300	35487.142	35487.148	0,29	35487.143	0,31

levering inclusief:
8 slotbouten M6 x 12
en flensmoeren

supplied complete with:
8 lock screws M6 x 12
and flange nuts

Vervalstuk 45°
Vertical outer bend 45°

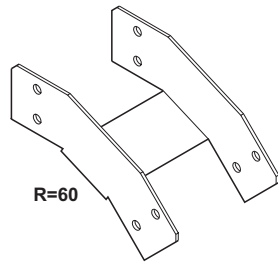

incl.
8x

Vervalstuk 90°
Vertical outer bend 90°

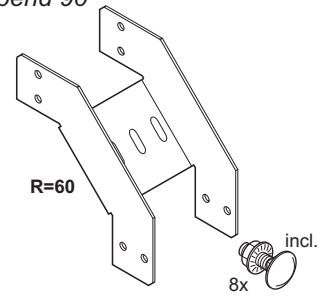

incl.
8x

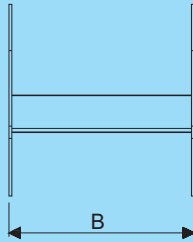
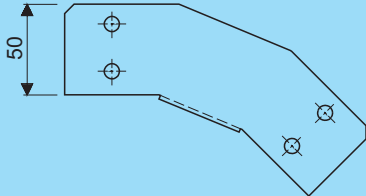

Vervalstuk 45°
Vertical outer bend 45°

B W	Artikel nr. Product no.			Artikel nr. Product no.	
	Senz.v. Mill galv.	Senz.v. gelakt Mill galv./coated	Gewicht Weight	Therm.v. Hot dip galv.	Gewicht Weight
50	32501.152	32501.158	0,22	32501.153	0,23
75	32502.152	32502.158	0,22	32502.153	0,24
100	32503.152	32503.158	0,23	32503.153	0,25
150	32504.152	32504.158	0,25	32504.153	0,27
200	32505.152	32505.158	0,27	32505.153	0,29
250	32506.152	32506.158	0,29	32506.153	0,31
300	32507.152	32507.158	0,31	32507.153	0,33

Vervalstukdeksel 45°
Vertical outer bend cover 45°

Artikel nr. Product no.			Artikel nr. Product no.	
Senz.v. Mill galv.	Senz.v. gelakt Mill galv./coated	Gewicht Weight	Therm.v. Hot dip galv.	Gewicht Weight
35501.142	35501.148	0,06	35501.143	0,06
35502.142	35502.148	0,08	35502.143	0,08
35503.142	35503.148	0,10	35503.143	0,11
35504.142	35504.148	0,15	35504.143	0,16
35505.142	35505.148	0,19	35505.143	0,21
35506.142	35506.148	0,23	35506.143	0,25
35507.142	35507.148	0,29	35507.143	0,31

levering inclusief:
8 slotbouten M6 x 12
en flensmoeren

supplied complete with:
8 lock screws M6 x 12
and flange nuts

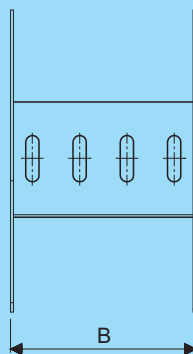
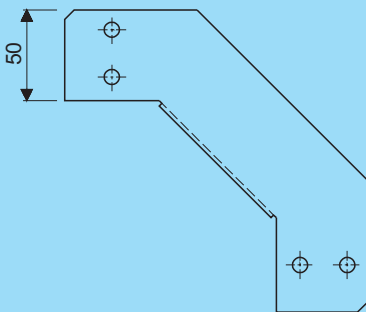

Vervalstuk 90°
Vertical outer bend 90°

B W	Artikel nr. Product no.			Artikel nr. Product no.	
	Senz.v. Mill galv.	Senz.v. gelakt Mill galv./coated	Gewicht Weight	Therm.v. Hot dip galv.	Gewicht Weight
50	32521.152	32521.158	0,27	32521.153	0,28
75	32522.152	32522.158	0,28	32522.153	0,30
100	32523.152	32523.158	0,30	32523.153	0,33
150	32524.152	32524.158	0,33	32524.153	0,35
200	32525.152	32525.158	0,36	32525.153	0,38
250	32526.152	32526.158	0,39	32526.153	0,41
300	32527.152	32527.158	0,42	32527.153	0,45

Vervalstukdeksel 90°
Vertical outer bend cover 90°

Artikel nr. Product no.			Artikel nr. Product no.	
Senz.v. Mill galv.	Senz.v. gelakt Mill galv./coated	Gewicht Weight	Therm.v. Hot dip galv.	Gewicht Weight
35521.142	35521.148	0,10	35521.143	0,10
35522.142	35522.148	0,14	35522.143	0,15
35523.142	35523.148	0,22	35523.143	0,24
35524.142	35524.148	0,26	35524.143	0,27
35525.142	35525.148	0,33	35525.143	0,36
35526.142	35526.148	0,40	35526.143	0,43
35527.142	35527.148	0,49	35527.143	0,53

levering inclusief:
8 slotbouten M6 x 12
en flensmoeren

supplied complete with:
8 lock screws M6 x 12
and flange nuts

Tray H78R

Kabelkanaal H53R
Cable duct H53R

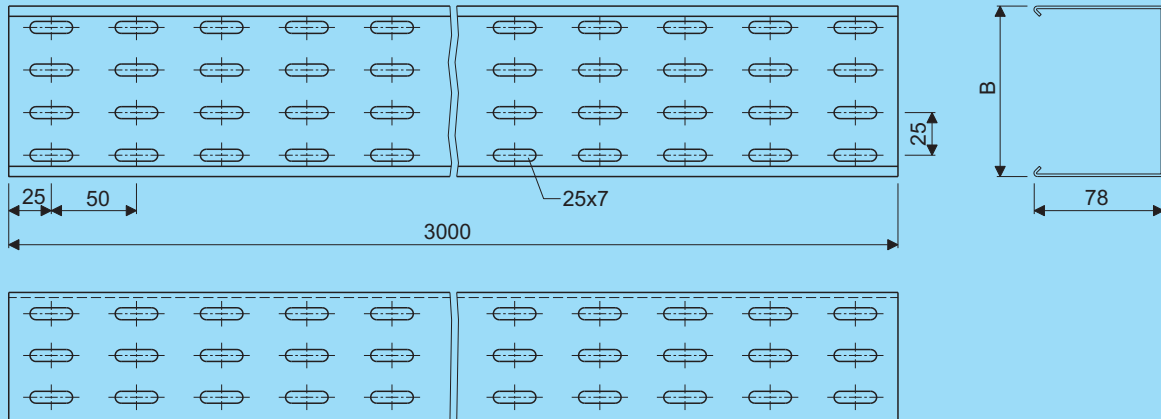
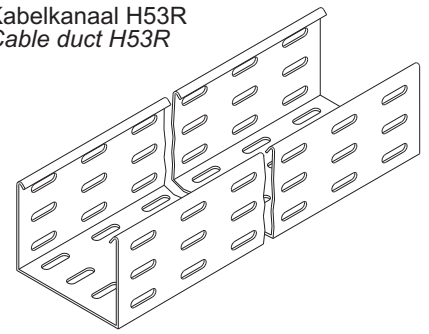

Kabelkanaal - H78R
Cable duct - H78R

B W	Artikel nr. Product no.			Artikel nr. Product no.	
	Senz.v. Mill galv.	Senz.v. gelakt Mill galv./coated	Gewicht Weight	Therm.v. Hot dip galv.	Gewicht Weight
75	33082.152	33082.158	4,76	33082.153	7,90
100	33083.152	33083.158	5,25	33083.153	8,72
150	33084.152	33084.158	6,24	33084.153	10,36
200	33085.152	33085.158	7,22	33085.153	11,99
250	33086.152	33086.158	8,20	33086.153	13,63
300	33087.152	33087.158	9,19	33087.153	15,27

Kabelkanaaldeksel
Cable duct cover

B W	Artikel nr. Product no.			Artikel nr. Product no.	
	Senz.v. Mill galv.	Senz.v. gelakt Mill galv./coated	Gewicht Weight	Therm.v. Hot dip galv.	Gewicht Weight
75	35042.142	35042.148	2,30	35042.143	2,51
100	35043.142	35043.148	2,90	35043.143	3,12
150	35044.142	35044.148	4,10	35044.143	4,47
200	35045.142	35045.148	5,30	35045.143	5,78
250	35046.142	35046.148	6,50	35046.143	7,09
300	35047.142	35047.148	7,70	35047.143	8,40

bestel de benodigde koppelplaten apart,
zij worden niet geleverd bij de kanalen
*order splice plates as separate items,
they are not supplied with the cable ducts*

Dekselveer
Cover spring

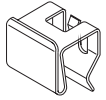

Dekselklem
Cover clamp

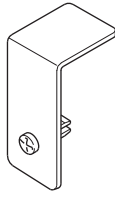

Sluitband met tape
Fastener with tape

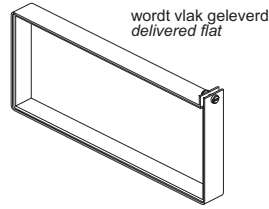

min. 1 st. per meter
min. 1 pc. per meter

Sluitband zonder tape
Fastener without tape

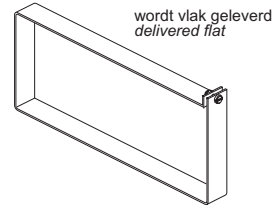

min. 1 st. per meter
min. 1 pc. per meter

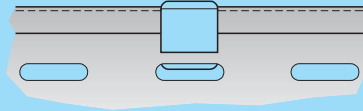
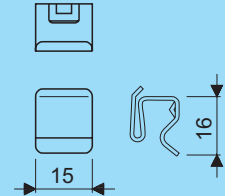

montage-toepassing
mounting application

Dekselveer Cover spring	
Artikel nr. Product no.	Gewicht Weight
99983.209	0,002

alleen voor send.z en sendz. gelakt
only for mill galv. and mill galv./coated

bestel de benodigde deksel-
veleren apart, zij worden niet
geleverd bij de deksels

kindly order cover springs as
a separate item, they are
not supplied with the covers

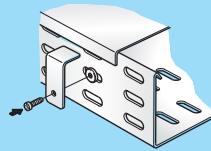
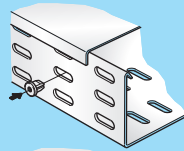
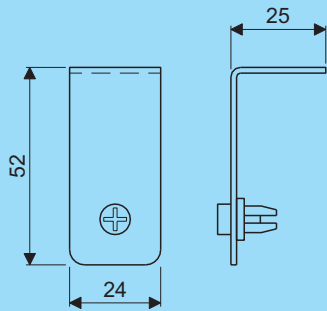

montage-toepassing
mounting application

Dekselklem Cover clamp				
Artikel nr. Product no.		Artikel nr. Product no.		
Sendz.v. Mill galv.	Sendz.v. gelakt Mill galv./coated	Gewicht Weight	Therm.v. Hot dip galv.	Gewicht Weight
99984.202	99984.208	0,02	99984.203	0,02

levering inclusief
nylon plaatmoer en
bolkopschroef
supplied complete
with plate nut and
roundhead screw

bestel de benodigde deksel-
klemmen apart, zij worden
niet geleverd bij de deksels
kindly order cover clamps
as a separate item, they are
not supplied with the covers

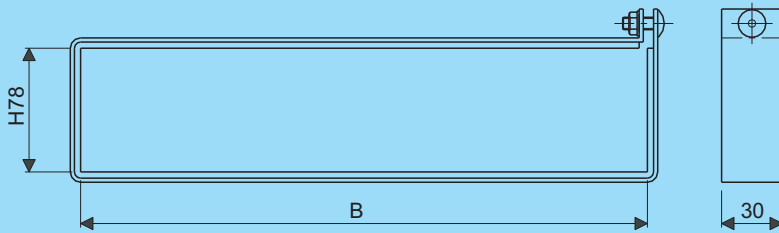

levering inclusief:
1 slotbout M6 x 12
en flensmoer

supplied complete with:
1 lock screw M6 x 12
and flange nut

Sluitband met tape Fastener with tape		
B	Artikel nr. Product no.	Gewicht Weight
	AISI 304	
75	33602.154	0,09
100	33603.154	0,11
150	33604.154	0,13
200	33605.154	0,15
250	33606.154	0,18
300	33607.154	0,20

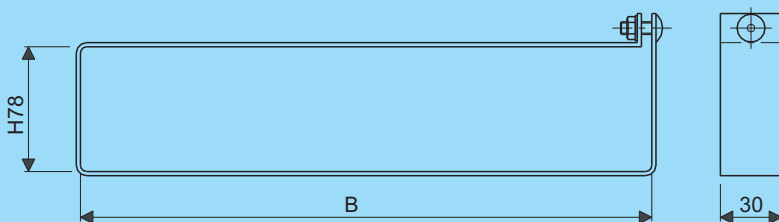

levering inclusief:
1 slotbout M6 x 12
en flensmoer

supplied complete with:
1 lock screw M6 x 12
and flange nut

Sluitband zonder tape Fastener without tape		
B	Artikel nr. Product no.	Gewicht Weight
	AISI 304	
75	33612.154	0,09
100	33613.154	0,11
150	33614.154	0,13
200	33615.154	0,15
250	33616.154	0,18
300	33617.154	0,20

Koppelplaat
Splice plate

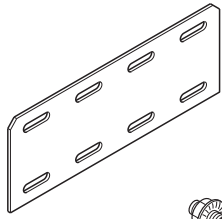

Scharnierende koppelplaat
Hinged splice plate

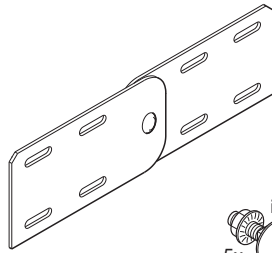

Scheidingsschot
Separation strip

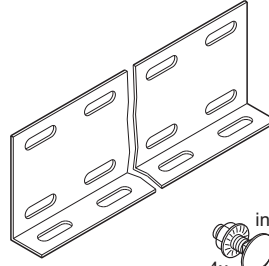

Eindschot/Verloopkoppelplaat
Endplate/Reducer splice plate

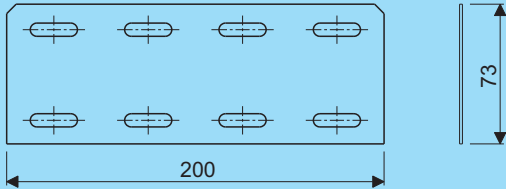
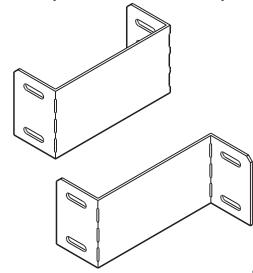

Koppelplaat
Splice plate

Artikel nr. Product no.			Artikel nr. Product no.	
Senz.v. Mill galv.	Senz.v. gelakt Mill galv./coated	Gewicht Weight	Therm.v. Hot dip galv.	Gewicht Weight
33132.152	33132.158	0,14	33132.153	0,20

levering inclusief:
4 slotbouten M6 x12
en flensmoeren

supplied complete with:
4 lock screws M6 x 12
and flange nuts

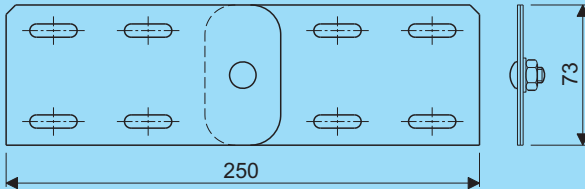

Scharnierende koppelplaat
Hinged splice plate

Artikel nr. Product no.			Artikel nr. Product no.	
Senz.v. Mill galv.	Senz.v. gelakt Mill galv./coated	Gewicht Weight	Therm.v. Hot dip galv.	Gewicht Weight
33151.152	33151.158	0,27	33151.153	0,29

levering inclusief:
5 slotbouten M6 x12
en flensmoeren

supplied complete with:
5 lock screws M6 x 12
and flange nuts

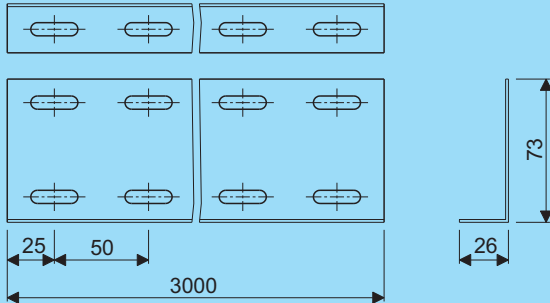

Scheidingsschot
Separation strip

Artikel nr. Product no.			Artikel nr. Product no.	
Senz.v. Mill galv.	Senz.v. gelakt Mill galv./coated	Gewicht Weight	Therm.v. Hot dip galv.	Gewicht Weight
98725.152	98725.158	2,00	98725.153	3,23

levering inclusief:
4 slotbouten M6 x12
en flensmoeren

supplied complete with:
4 lock screws M6 x 12
and flange nuts

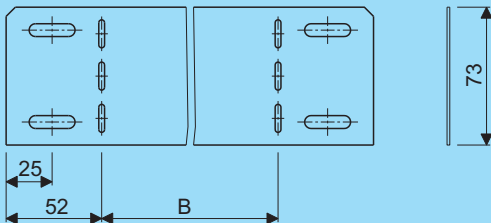

Eindschot/Verloopkoppelplaat
Endplate/Reducer splice plate

B W	Artikel nr. Product no.			Artikel nr. Product no.	
	Senz.v. Mill galv.	Senz.v. gelakt Mill galv./coated	Gewicht Weight	Therm.v. Hot dip galv.	Gewicht Weight
25	33170.152	33170.158	0,11	33170.153	0,11
50	33171.152	33171.158	0,12	33171.153	0,12
75	33172.152	33172.158	0,13	33172.153	0,14
100	33173.152	33173.158	0,14	33173.153	0,15
150	33174.152	33174.158	0,17	33174.153	0,18
200	33175.152	33175.158	0,20	33175.153	0,22
250	33176.152	33176.158	0,23	33176.153	0,25
300	33177.152	33177.158	0,26	33177.153	0,28

levering inclusief:
4 slotbouten M6 x12
en flensmoeren

supplied complete with:
4 lock screws M6 x 12
and flange nuts

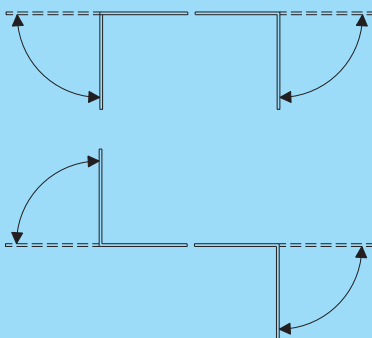

Tray H78

Tray

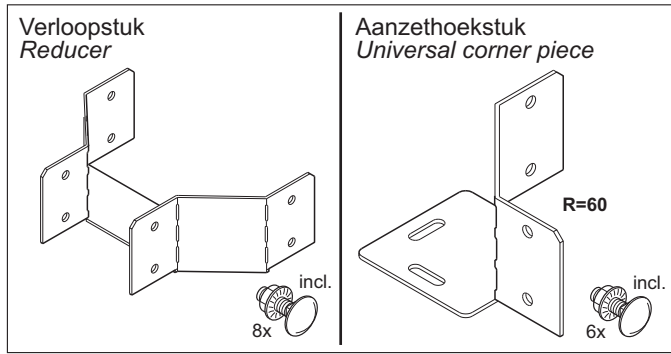
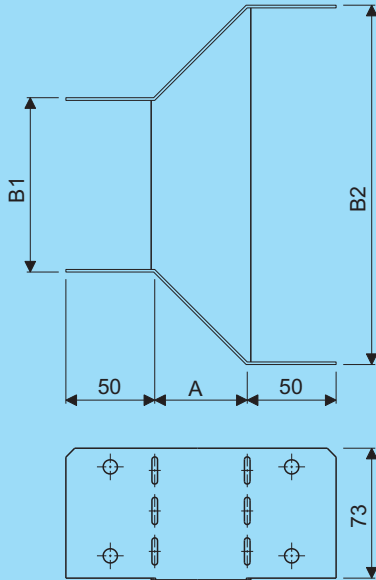

Verloopstuk Reducer						
A	B1-B2	Artikel nr. Product no.			Artikel nr. Product no.	
		Sendz.v. Mill galv.	Sendz.v. gelakt Mill galv./coated	Gewicht Weight	Therm.v. Hot dip galv.	Gewicht Weight
47	75-100	33194.152	33194.158	0,28	33194.153	0,29
38	75-150	33195.152	33195.158	0,28	33195.153	0,30
63	75-200	33196.152	33196.158	0,36	33196.153	0,38
44	100-150	33197.152	33197.158	0,29	33197.153	0,31
50	100-200	33198.152	33198.158	0,33	33198.153	0,35
75	100-250	33199.152	33199.158	0,42	33199.153	0,45
44	150-200	33200.152	33200.158	0,31	33200.153	0,33
50	150-250	33201.152	33201.158	0,35	33201.153	0,38
75	150-300	33202.152	33202.158	0,45	33202.153	0,48
44	200-250	33203.152	33203.158	0,33	33203.153	0,35
50	200-300	33204.152	33204.158	0,37	33204.153	0,40
44	250-300	33206.152	33206.158	0,34	33206.153	0,37

Verloopstukdeksel Reducer cover						
A	B1-B2	Artikel nr. Product no.			Artikel nr. Product no.	
		Sendz.v. Mill galv.	Sendz.v. gelakt Mill galv./coated	Gewicht Weight	Therm.v. Hot dip galv.	Gewicht Weight
47	75-100	35194.142	35194.148	0,06	35194.143	0,07
38	75-150	35195.142	35195.148	0,07	35195.143	0,07
63	75-200	35196.142	35196.148	0,11	35196.143	0,12
44	100-150	35197.142	35197.148	0,08	35197.143	0,09
50	100-200	35198.142	35198.148	0,11	35198.143	0,12
75	100-250	35199.142	35199.148	0,16	35199.143	0,18
44	150-200	35200.142	35200.148	0,11	35200.143	0,12
50	150-250	35201.142	35201.148	0,14	35201.143	0,15
75	150-300	35202.142	35202.148	0,20	35202.143	0,22
44	200-250	35203.142	35203.148	0,14	35203.143	0,15
50	200-300	35204.142	35204.148	0,17	35204.143	0,18
44	250-300	35206.142	35206.148	0,17	35206.143	0,18

levering inclusief:
8 slotbouten M6 x 12
en flensmoeren

supplied complete with:
8 lock screws M6 x 12
and flange nuts

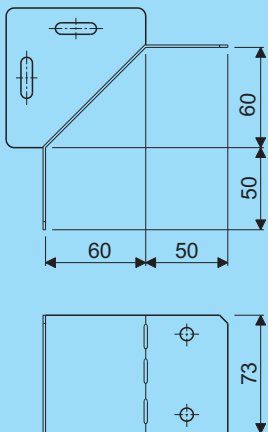

Aanzethoekstuk Universal corner piece				
Artikel nr. Product no.			Artikel nr. Product no.	
Sendz.v. Mill galv.	Sendz.v. gelakt Mill galv./coated	Gewicht Weight	Therm.v. Hot dip galv.	Gewicht Weight
33221.152	33221.158	0,22	33221.153	0,23

levering inclusief:
4 slotbouten M6 x 12
en flensmoeren

supplied complete with:
4 lock screws M6 x 12
and flange nuts

Tray H78

Hoekstuk 45°
Corner piece 45°

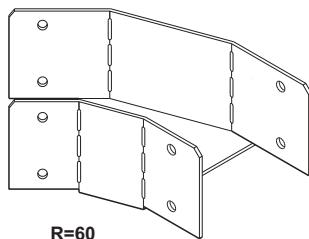

R=60



Hoekstuk 90°
Corner piece 90°

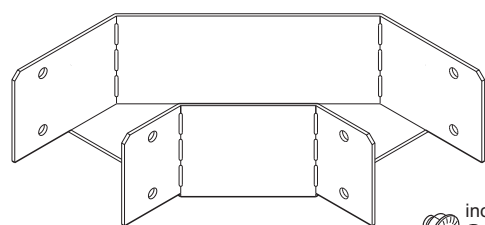

R=60

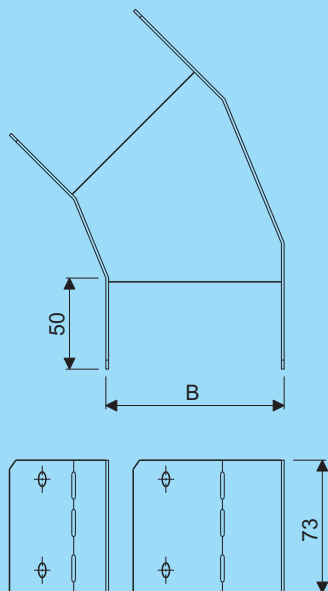

Hoekstuk 45°
Corner piece 45°

B W	Artikel nr. Product no.			Artikel nr. Product no.	
	Senz.v. Mill galv.	Senz.v. gelakt Mill galv./coated	Gewicht Weight	Therm.v. Hot dip galv.	Gewicht Weight
75	33242.152	33242.158	0,29	33242.153	0,31
100	33243.152	33243.158	0,32	33243.153	0,34
150	33244.152	33244.158	0,39	33244.153	0,42
200	33245.152	33245.158	0,47	33245.153	0,50
250	33246.152	33246.158	0,56	33246.153	0,60
300	33247.152	33247.158	0,67	33247.153	0,72

Hoekstukdeksel 45°
Corner piece cover 45°

B W	Artikel nr. Product no.			Artikel nr. Product no.	
	Senz.v. Mill galv.	Senz.v. gelakt Mill galv./coated	Gewicht Weight	Therm.v. Hot dip galv.	Gewicht Weight
75	35242.142	35242.148	0,07	35242.143	0,08
100	35243.142	35243.148	0,10	35243.143	0,11
150	35244.142	35244.148	0,17	35244.143	0,19
200	35245.142	35245.148	0,26	35245.143	0,28
250	35246.142	35246.148	0,36	35246.143	0,40
300	35247.142	35247.148	0,48	35247.143	0,52

levering inclusief:
8 slotbouten M6 x 12
en flensmoeren

supplied complete with:
8 lock screws M6 x 12
and flange nuts

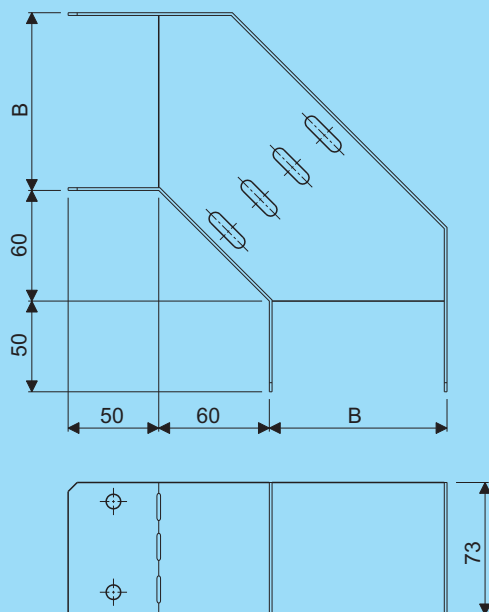

Hoekstuk 90°
Corner piece 90°

B W	Artikel nr. Product no.			Artikel nr. Product no.	
	Senz.v. Mill galv.	Senz.v. gelakt Mill galv./coated	Gewicht Weight	Therm.v. Hot dip galv.	Gewicht Weight
75	33262.152	33262.158	0,45	33262.153	0,48
100	33263.152	33263.158	0,52	33263.153	0,56
150	33264.152	33264.158	0,68	33264.153	0,73
200	33265.152	33265.158	0,82	33265.153	0,89
250	33266.152	33266.158	1,10	33266.153	1,19
300	33267.152	33267.158	1,36	33267.153	1,47

Hoekstukdeksel 90°
Corner piece cover 90°

B W	Artikel nr. Product no.			Artikel nr. Product no.	
	Senz.v. Mill galv.	Senz.v. gelakt Mill galv./coated	Gewicht Weight	Therm.v. Hot dip galv.	Gewicht Weight
75	35262.142	35262.148	0,12	35262.143	0,13
100	35263.142	35263.148	0,18	35263.143	0,20
150	35264.142	35264.148	0,32	35264.143	0,35
200	35265.142	35265.148	0,50	35265.143	0,54
250	35266.142	35266.148	0,67	35266.143	0,73
300	35267.142	35267.148	0,87	35267.143	0,97

levering inclusief:
8 slotbouten M6 x 12
en flensmoeren

supplied complete with:
8 lock screws M6 x 12
and flange nuts

Tray H78

Aftakstuk
Branch

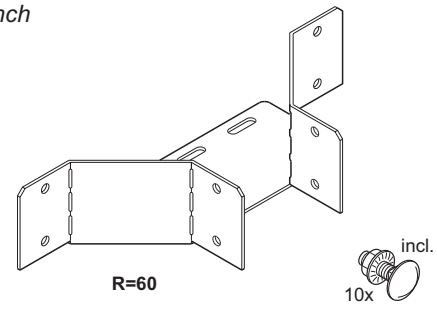

Tray

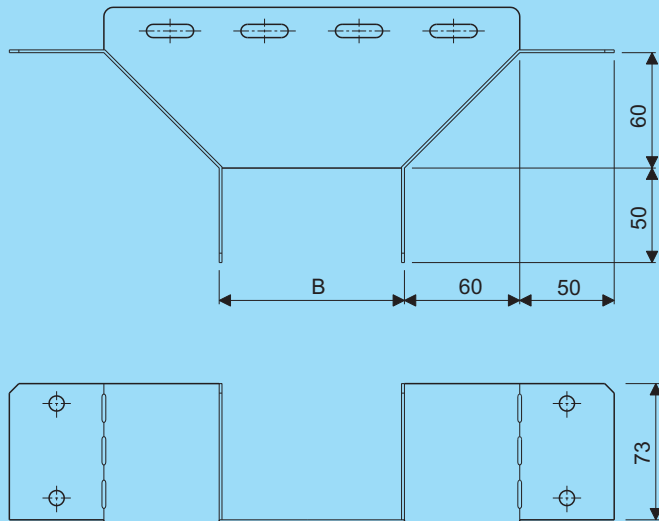

Aftakstuk Branch					
B W	Artikel nr. Product no.			Artikel nr. Product no.	
	Sendz.v. Mill galv.	Sendz.v. gelakt Mill galv./coated	Gewicht Weight	Therm.v. Hot dip galv.	Gewicht Weight
75	33282.152	33282.158	0,41	33282.153	0,44
100	33283.152	33283.158	0,47	33283.153	0,50
150	33284.152	33284.158	0,61	33284.153	0,66
200	33285.152	33285.158	0,80	33285.153	0,86
250	33286.152	33286.158	1,02	33286.153	1,10
300	33287.152	33287.158	1,28	33287.153	1,39

Aftakstukdeksel Branch cover					
B W	Artikel nr. Product no.			Artikel nr. Product no.	
	Sendz.v. Mill galv.	Sendz.v. gelakt Mill galv./coated	Gewicht Weight	Therm.v. Hot dip galv.	Gewicht Weight
75	35282.142	35282.148	0,11	35282.143	0,12
100	35283.142	35283.148	0,12	35283.143	0,13
150	35284.142	35284.148	0,18	35284.143	0,19
200	35285.142	35285.148	0,19	35285.143	0,21
250	35286.142	35286.148	0,24	35286.143	0,26
300	35287.142	35287.148	0,27	35287.143	0,29

levering inclusief:
8 slotbouten M6 x 12
en flensmoeren

supplied complete with:
8 lock screws M6 x 12
and flange nuts

Tray H78

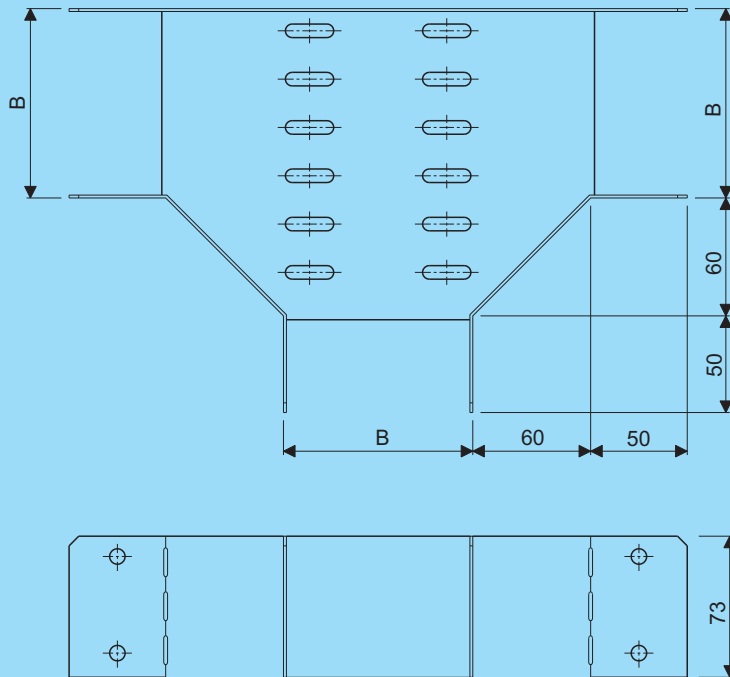
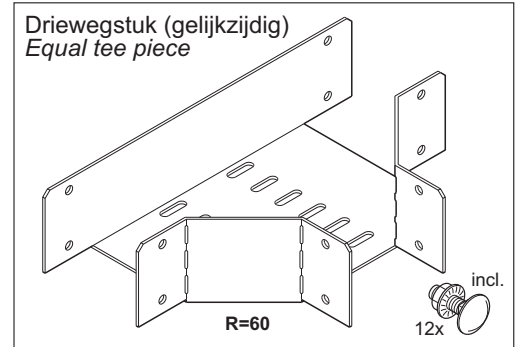

Driewegstuk (gelijkzijdig) Equal tee piece					
B W	Artikel nr. Product no.			Artikel nr. Product no.	
	Sendz.v. Mill galv.	Sendz.v. gelakt Mill galv./coated	Gewicht Weight	Therm.v. Hot dip galv.	Gewicht Weight
75	33302.152	33302.158	0,64	33302.153	0,69
100	33303.152	33303.158	0,73	33303.153	0,78
150	33304.152	33304.158	0,92	33304.153	0,99
200	33305.152	33305.158	1,16	33305.153	1,25
250	33306.152	33306.158	1,43	33306.153	1,55
300	33307.152	33307.158	1,74	33307.153	1,89

Driewegstukdeksel (gelijkzijdig) Equal tee piece cover					
B W	Artikel nr. Product no.			Artikel nr. Product no.	
	Sendz.v. Mill galv.	Sendz.v. gelakt Mill galv./coated	Gewicht Weight	Therm.v. Hot dip galv.	Gewicht Weight
75	35302.142	35302.148	0,24	35302.143	0,26
100	35303.142	35303.148	0,31	35303.143	0,34
150	35304.142	35304.148	0,50	35304.143	0,55
200	35305.142	35305.148	0,74	35305.143	0,81
250	35306.142	35306.148	1,02	35306.143	1,11
300	35307.142	35307.148	1,33	35307.143	1,45

levering inclusief:
12 slotbouten M6 x 12
en flensmoeren

supplied complete with:
12 lock screws M6 x 12
and flange nuts

Tray H78

Driewegstuk (ongelijkzijdig)
Unequal tee piece (reducing)

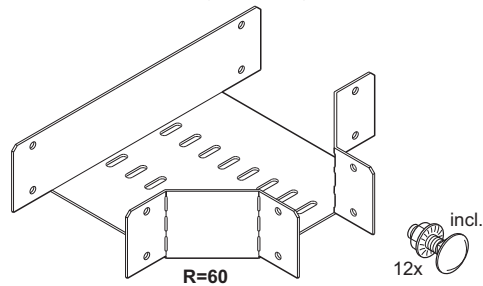

Tray

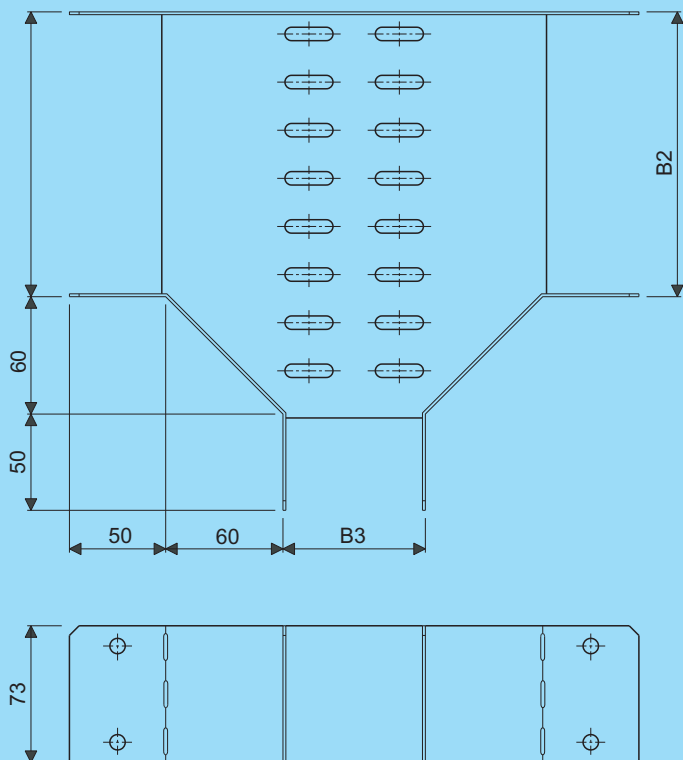

Driewegstuk (ongelijkzijdig) Unequal tee piece (reducing)						Driewegstukdeksel (ongelijkzijdig) Unequal tee piece cover (reducing)						
B1-B2-B3	Artikel nr. Product no.			Artikel nr. Product no.			Artikel nr. Product no.			Artikel nr. Product no.		
	Sendz.v. Mill galv.	Sendz.v. gelakt Mill galv./coated	Gewicht Weight	Therm.v. Hot dip galv.	Gewicht Weight	Sendz.v. Mill galv.	Sendz.v. gelakt Mill galv./coated	Gewicht Weight	Therm.v. Hot dip galv.	Gewicht Weight		
100-100- 75	33323.152	33323.158	0,68	33323.153	0,73	35323.142	35323.148	0,20	35323.143	0,22		
150-150- 75	33325.152	33325.158	0,75	33325.153	0,81	35325.142	35325.148	0,24	35325.143	0,27		
150-150-100	33326.152	33326.158	0,81	33326.153	0,87	35326.142	35326.148	0,27	35326.143	0,29		
200-200- 75	33328.152	33328.158	0,82	33328.153	0,90	35328.142	35328.148	0,32	35328.143	0,35		
200-200-100	33329.152	33329.158	0,89	33329.153	0,96	35329.142	35329.148	0,37	35329.143	0,40		
200-200-150	33330.152	33330.158	1,02	33330.153	1,10	35330.142	35330.148	0,42	35330.143	0,45		
250-250- 75	33332.152	33332.158	0,89	33332.153	0,96	35332.142	35332.148	0,40	35332.143	0,44		
250-250-100	33333.152	33333.158	0,92	33333.153	1,05	35333.142	35333.148	0,46	35333.143	0,50		
250-250-150	33334.152	33334.158	1,12	33334.153	1,21	35334.142	35334.148	0,52	35334.143	0,56		
250-250-200	33335.152	33335.158	1,28	33335.153	1,38	35335.142	35335.148	0,63	35335.143	0,69		
300-300- 75	33337.152	33337.158	0,96	33337.153	1,04	35337.142	35337.148	0,48	35337.143	0,53		
300-300-100	33338.152	33338.158	1,05	33338.153	1,14	35338.142	35338.148	0,55	35338.143	0,60		
300-300-150	33339.152	33339.158	1,22	33339.153	1,32	35339.142	35339.148	0,62	35339.143	0,67		
300-300-200	33340.152	33340.158	1,40	33340.153	1,51	35340.142	35340.148	0,75	35340.143	0,82		
300-300-250	33341.152	33341.158	1,57	33341.153	1,70	35341.142	35341.148	0,88	35341.143	0,96		

levering inclusief:
12 slotbouten M6 x 12
en flensmoeren

supplied complete with:
12 lock screws M6 x 12
and flange nuts

Tray H78

Driewegstuk (ongelijkzijdig)
Unequal tee piece (expanding)

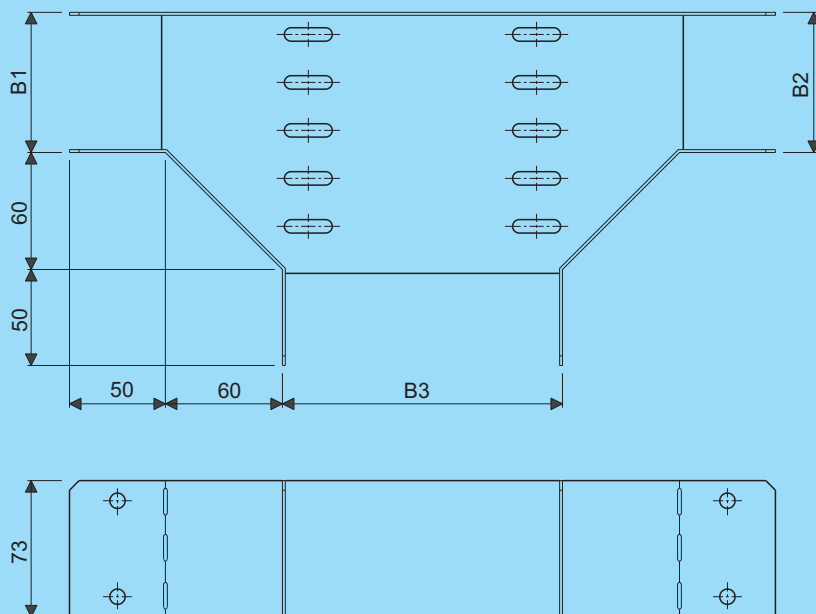
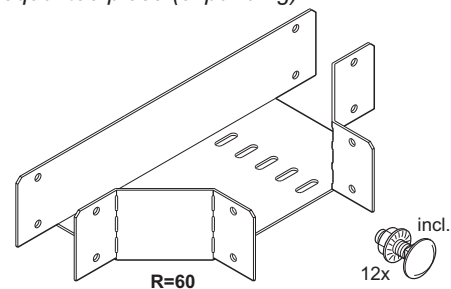

Driewegstuk (ongelijkzijdig) Unequal tee piece (expanding)					Driewegstukdeksel (ongelijkzijdig) Unequal tee piece cover (expanding)					
B1-B2-B3	Artikel nr. Product no.			Artikel nr. Product no.		Artikel nr. Product no.			Artikel nr. Product no.	
	Sendz.v. Mill galv.	Sendz.v. gelakt Mill galv./coated	Gewicht Weight	Therm.v. Hot dip galv.	Gewicht Weight	Sendz.v. Mill galv.	Sendz.v. gelakt Mill galv./coated	Gewicht Weight	Therm.v. Hot dip galv.	Gewicht Weight
75- 75-100	33367.152	33367.158	0,69	33367.153	0,74	35367.142	35367.148	0,27	35367.143	0,29
75- 75-150	33368.152	33368.158	0,77	33368.153	0,83	35368.142	35368.148	0,33	35368.143	0,36
75- 75-200	33369.152	33369.158	0,85	33369.153	0,92	35369.142	35369.148	0,39	35369.143	0,43
75- 75-250	33370.152	33370.158	0,94	33370.153	1,01	35370.142	35370.148	0,46	35370.143	0,50
75- 75-300	33371.152	33371.158	1,02	33371.153	1,10	35371.142	35371.148	0,52	35371.143	0,57
100-100-150	33372.152	33372.158	0,82	33372.153	0,88	35372.142	35372.148	0,39	35372.143	0,43
100-100-200	33373.152	33373.158	0,91	33373.153	0,99	35373.142	35373.148	0,46	35373.143	0,51
100-100-250	33374.152	33374.158	1,01	33374.153	1,09	35374.142	35374.148	0,54	35374.143	0,59
100-100-300	33375.152	33375.158	1,10	33375.153	1,19	35375.142	35375.148	0,61	35375.143	0,67
150-150-200	33376.152	33376.158	1,04	33376.153	1,12	35376.142	35376.148	0,60	35376.143	0,66
150-150-250	33377.152	33377.158	1,15	33377.153	1,24	35377.142	35377.148	0,70	35377.143	0,76
150-150-300	33378.152	33378.158	1,26	33378.153	1,37	35378.142	35378.148	0,79	35378.143	0,86
200-200-250	33379.152	33379.158	1,29	33379.153	1,40	35379.142	35379.148	0,86	35379.143	0,94
200-200-300	33380.152	33380.158	1,42	33380.153	1,54	35380.142	35380.148	0,97	35380.143	1,06
250-250-300	33381.152	33381.158	1,58	33381.153	1,72	35381.142	35381.148	1,15	35381.143	1,26

supplied complete with:
12 lock screws M6 x 12
and flange nuts

levering inclusief:
12 slotbouten M6 x 12
en flensmoeren

Tray H78

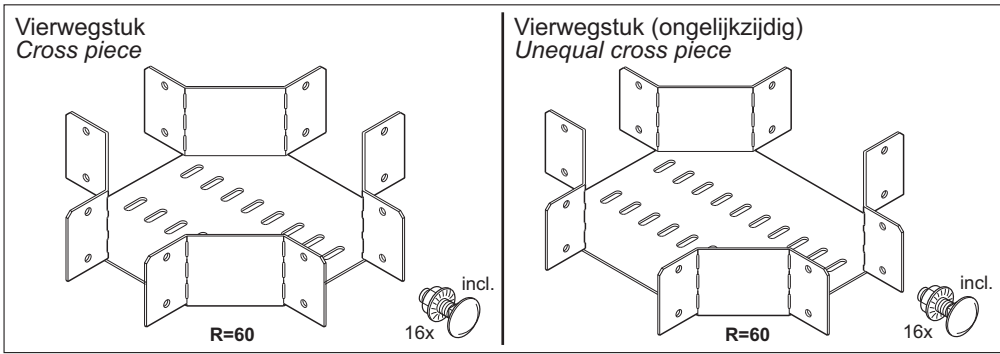

Tray

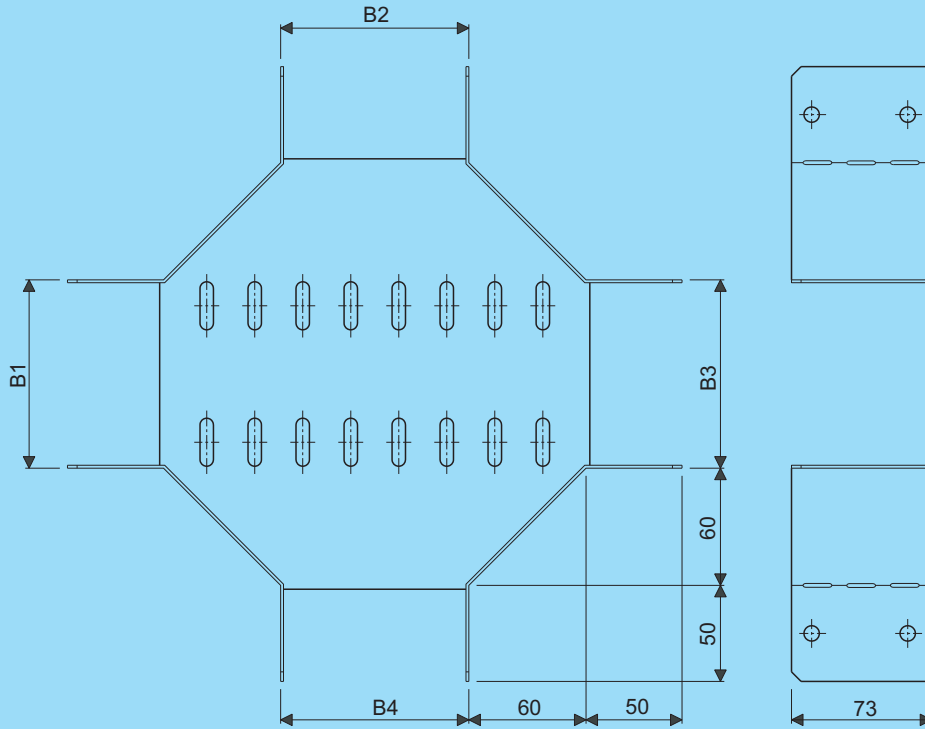

Vierwegstuk Cross piece						Vierwegstukdeksel Cross piece cover						
B1-B2-B3-B4	Artikel nr. Product no.			Artikel nr. Product no.			Artikel nr. Product no.			Artikel nr. Product no.		
	Sendz.v. Mill galv.	Sendz.v. gelakt Mill galv./coated	Gewicht Weight	Therm.v. Hot dip galv.	Gewicht Weight	Sendz.v. Mill galv.	Sendz.v. gelakt Mill galv./coated	Gewicht Weight	Therm.v. Hot dip galv.	Gewicht Weight		
75-75-75-75	33402.152	33402.158	0,85	33402.153	0,92	35402.142	35402.148	0,22	35402.143	0,24		
100-100-100-100	33403.152	33403.158	0,93	33403.153	1,00	35403.142	35403.148	0,29	35403.143	0,31		
150-150-150-150	33404.152	33404.158	1,12	33404.153	1,21	35404.142	35404.148	0,40	35404.143	0,44		
200-200-200-200	33405.152	33405.158	1,35	33405.153	1,46	35405.142	35405.148	0,58	35405.143	0,64		
250-250-250-250	33406.152	33406.158	1,62	33406.153	1,75	35406.142	35406.148	0,88	35406.143	0,96		
300-300-300-300	33407.152	33407.158	1,93	33407.153	2,09	35407.142	35407.148	1,18	35407.143	1,29		
100-75-100-75	33423.152	33423.158	0,89	33423.153	0,95	35423.142	35423.148	1,52	35423.143	1,66		
150-75-150-75	33425.152	33425.158	0,96	33425.153	1,03	35425.142	35425.148	0,26	35425.143	0,28		
150-100-150-100	33426.152	33426.158	1,01	33426.153	1,09	35426.142	35426.148	0,30	35426.143	0,33		
200-75-200-75	33428.152	33428.158	1,03	33428.153	1,11	35428.142	35428.148	0,35	35428.143	0,38		
200-100-200-100	33429.152	33429.158	1,09	33429.153	1,18	35429.142	35429.148	0,38	35429.143	0,41		
200-150-200-150	33430.152	33430.158	1,22	33430.153	1,32	35430.142	35430.148	0,44	35430.143	0,48		
250-75-250-75	33432.152	33432.158	1,10	33432.153	1,18	35432.142	35432.148	0,50	35432.143	0,55		
250-100-250-100	33433.152	33433.158	1,17	33433.153	1,27	35433.142	35433.148	0,46	35433.143	0,50		
250-150-250-150	33434.152	33434.158	1,32	33434.153	1,43	35434.142	35434.148	0,53	35434.143	0,58		
250-200-250-200	33435.152	33435.158	1,47	33435.153	1,59	35435.142	35435.148	0,60	35435.143	0,65		
300-75-300-75	33437.152	33437.158	1,17	33437.153	1,26	35437.142	35437.148	0,74	35437.143	0,81		
300-100-300-100	33438.152	33438.158	1,25	33438.153	1,35	35438.142	35438.148	0,54	35438.143	0,59		
300-150-300-150	33439.152	33439.158	1,42	33439.153	1,54	35439.142	35439.148	0,62	35439.143	0,68		
300-200-300-200	33440.152	33440.158	1,59	33440.153	1,72	35440.142	35440.148	0,70	35440.143	0,76		
300-250-300-250	33441.152	33441.158	1,76	33441.153	1,90	35441.142	35441.148	0,86	35441.143	0,94		

levering inclusief:
16 slotbouten M6 x 12
en flensmoeren

supplied complete with:
16 lock screws M6 x 12
and flange nuts

Tray H78

Stijgstuk 45°
Vertical inner bend 45°

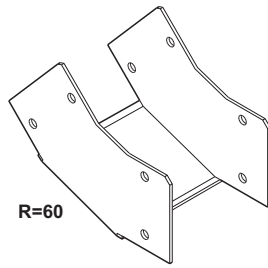

R=60



Stijgstuk 90°
Vertical inner bend 90°

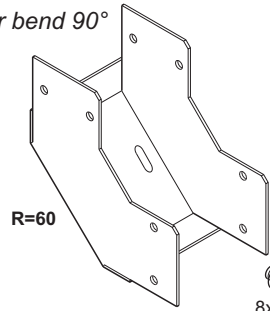

R=60

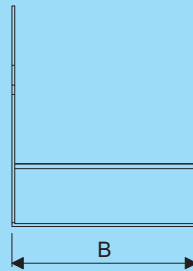
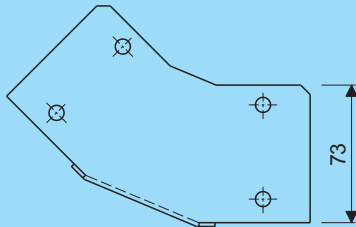

B W	Artikel nr. Product no.			Artikel nr. Product no.	
	Senz.v. Mill galv.	Senz.v. gelakt Mill galv./coated	Gewicht Weight	Therm.v. Hot dip galv.	Gewicht Weight
75	33462.152	33462.158	0,32	33462.153	0,35
100	33463.152	33463.158	0,34	33463.153	0,37
150	33464.152	33464.158	0,38	33464.153	0,41
200	33465.152	33465.158	0,43	33465.153	0,46
250	33466.152	33466.158	0,47	33466.153	0,50
300	33467.152	33467.158	0,51	33467.153	0,55

Stijgstukdeksel 45° Vertical inner bend cover 45°					
B W	Artikel nr. Product no.			Artikel nr. Product no.	
	Senz.v. Mill galv.	Senz.v. gelakt Mill galv./coated	Gewicht Weight	Therm.v. Hot dip galv.	Gewicht Weight
75	35462.142	35462.148	0,05	35462.143	0,06
100	35463.142	35463.148	0,07	35463.143	0,07
150	35464.142	35464.148	0,10	35464.143	0,11
200	35465.142	35465.148	0,13	35465.143	0,14
250	35466.142	35466.148	0,15	35466.143	0,17
300	35467.142	35467.148	0,19	35467.143	0,21

levering inclusief:
8 slotbouten M6 x 12
en flensmoeren

supplied complete with:
8 lock screws M6 x 12
and flange nuts

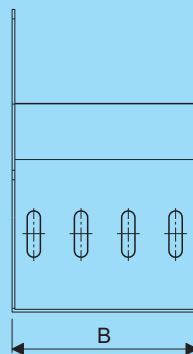
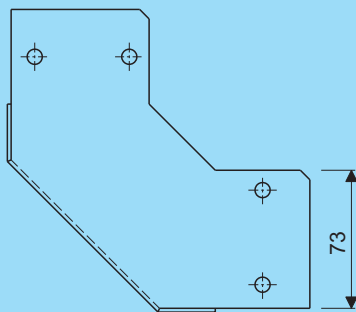

B W	Artikel nr. Product no.			Artikel nr. Product no.	
	Senz.v. Mill galv.	Senz.v. gelakt Mill galv./coated	Gewicht Weight	Therm.v. Hot dip galv.	Gewicht Weight
75	33482.152	33482.158	0,45	33482.153	0,49
100	33483.152	33483.158	0,49	33483.153	0,53
150	33484.152	33484.158	0,57	33484.153	0,62
200	33485.152	33485.158	0,65	33485.153	0,71
250	33486.152	33486.158	0,73	33486.153	0,79
300	33487.152	33487.158	0,81	33487.153	0,88

Stijgstukdeksel 90° Vertical inner bend cover 90°					
B W	Artikel nr. Product no.			Artikel nr. Product no.	
	Senz.v. Mill galv.	Senz.v. gelakt Mill galv./coated	Gewicht Weight	Therm.v. Hot dip galv.	Gewicht Weight
75	35482.142	35482.148	0,08	35482.143	0,09
100	35483.142	35483.148	0,10	35483.143	0,11
150	35484.142	35484.148	0,15	35484.143	0,16
200	35485.142	35485.148	0,20	35485.143	0,21
250	35486.142	35486.148	0,23	35486.143	0,25
300	35487.142	35487.148	0,29	35487.143	0,31

levering inclusief:
8 slotbouten M6 x 12
en flensmoeren

supplied complete with:
8 lock screws M6 x 12
and flange nuts

Tray H78

Vervalstuk 45°
Vertical outer bend 45°

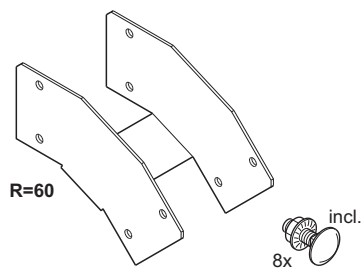

Vervalstuk 90°
Vertical outer bend 90°

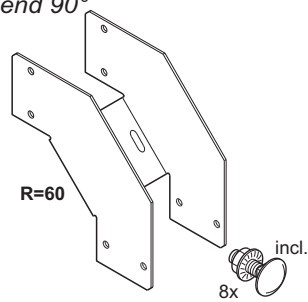

Tray

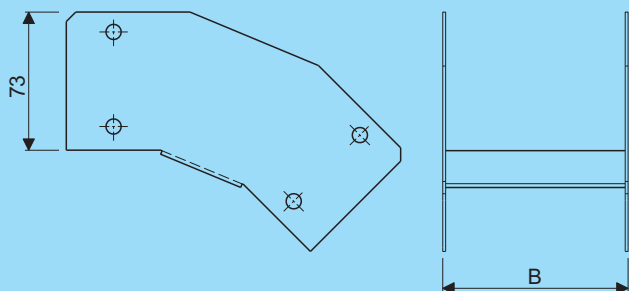

Vervalstuk 45° Vertical outer bend 45°					
B W	Artikel nr. Product no.			Artikel nr. Product no.	
	Sendz.v. Mill galv.	Sendz.v. gelakt Mill galv./coated	Gewicht Weight	Therm.v. Hot dip galv.	Gewicht Weight
75	33502.152	33502.158	0,29	33502.153	0,31
100	33503.152	33503.158	0,30	33503.153	0,32
150	33504.152	33504.158	0,32	33504.153	0,34
200	33505.152	33505.158	0,34	33505.153	0,36
250	33506.152	33506.158	0,35	33506.153	0,38
300	33507.152	33507.158	0,37	33507.153	0,40

Vervalstukdeksel 45° Vertical outer bend cover 45°					
B W	Artikel nr. Product no.			Artikel nr. Product no.	
	Sendz.v. Mill galv.	Sendz.v. gelakt Mill galv./coated	Gewicht Weight	Therm.v. Hot dip galv.	Gewicht Weight
75	35602.142	35602.148	0,08	35602.143	0,09
100	35603.142	35603.148	0,11	35603.143	0,12
150	35604.142	35604.148	0,16	35604.143	0,18
200	35605.142	35605.148	0,22	35605.143	0,24
250	35606.142	35606.148	0,27	35606.143	0,30
300	35607.142	35607.148	0,33	35607.143	0,36

levering inclusief:
8 slotbouten M6 x 12
en flensmoeren

supplied complete with:
8 lock screws M6 x 12
and flange nuts

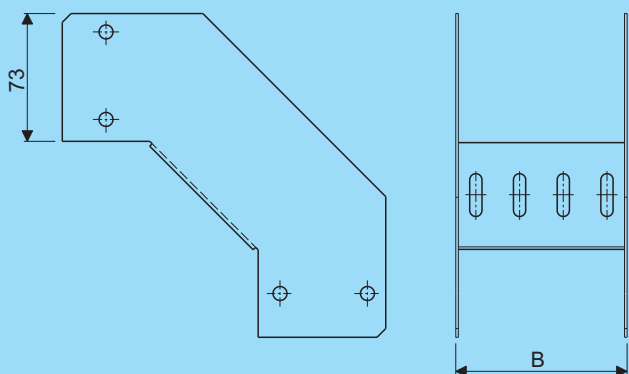

Vervalstuk 90° Vertical outer bend 90°					
B W	Artikel nr. Product no.			Artikel nr. Product no.	
	Sendz.v. Mill galv.	Sendz.v. gelakt Mill galv./coated	Gewicht Weight	Therm.v. Hot dip galv.	Gewicht Weight
75	33522.152	33522.158	0,38	33522.153	0,41
100	33523.152	33523.158	0,40	33523.153	0,43
150	33524.152	33524.158	0,43	33524.153	0,46
200	33525.152	33525.158	0,46	33525.153	0,50
250	33526.152	33526.158	0,49	33526.153	0,53
300	33527.152	33527.158	0,52	33527.153	0,56

Vervalstukdeksel 90° Vertical outer bend cover 90°					
B W	Artikel nr. Product no.			Artikel nr. Product no.	
	Sendz.v. Mill galv.	Sendz.v. gelakt Mill galv./coated	Gewicht Weight	Therm.v. Hot dip galv.	Gewicht Weight
75	35622.142	35622.148	0,15	35622.143	0,16
100	35623.142	35623.148	0,19	35623.143	0,21
150	35624.142	35624.148	0,29	35624.143	0,32
200	35625.142	35625.148	0,39	35625.143	0,42
250	35626.142	35626.148	0,48	35626.143	0,52
300	35627.142	35627.148	0,58	35627.143	0,63

levering inclusief:
8 slotbouten M6 x 12
en flensmoeren

supplied complete with:
8 lock screws M6 x 12
and flange nuts

Tray H103R

Kabelkanaal H53R
Cable duct H53R

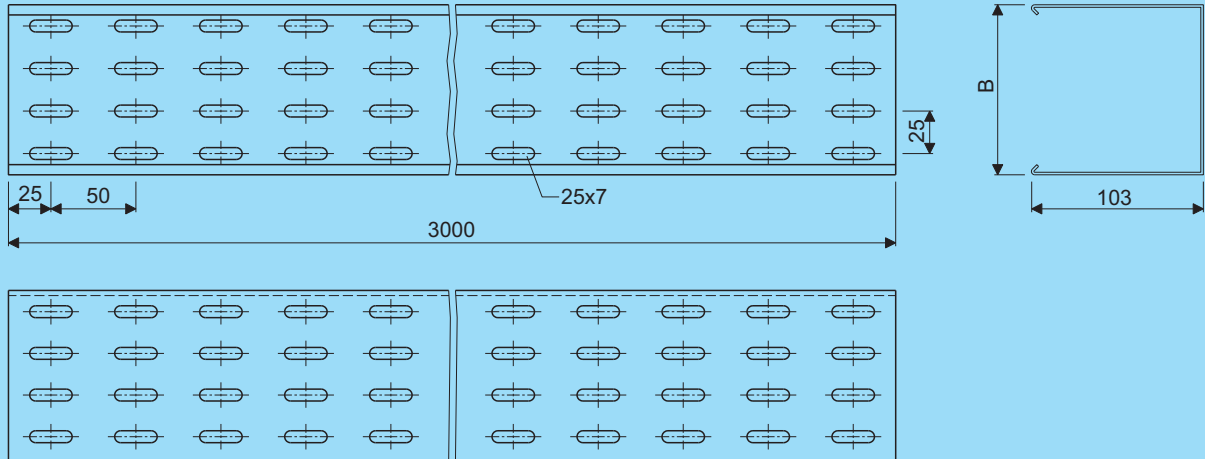
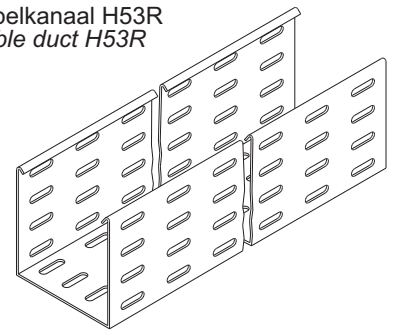

Kabelkanaal - H103R Cable duct - H103R					
B W	Artikel nr. Product no.			Artikel nr. Product no.	
	Senz.v. Mill galv.	Senz.v. gelakt Mill galv./coated	Gewicht Weight	Therm.v. Hot dip galv.	Gewicht Weight
100	34083.152	34083.158	6,24	34083.153	10,36
150	34084.152	34084.158	7,22	34084.153	11,99
200	34085.152	34085.158	8,20	34085.153	13,63
250	34086.152	34086.158	9,19	34086.153	15,26
300	34087.152	34087.158	10,18	34087.153	16,90

Kabelkanaaldeksel Cable duct cover					
B W	Artikel nr. Product no.			Artikel nr. Product no.	
	Senz.v. Mill galv.	Senz.v. gelakt Mill galv./coated	Gewicht Weight	Therm.v. Hot dip galv.	Gewicht Weight
100	35043.142	35043.148	2,90	35043.143	3,12
150	35044.142	35044.148	4,10	35044.143	4,47
200	35045.142	35045.148	5,30	35045.143	5,78
250	35046.142	35046.148	6,50	35046.143	7,09
300	35047.142	35047.148	7,70	35047.143	8,40

bestel de benodigde koppelplaten apart,
zij worden niet geleverd bij de kanalen
*order splice plates as separate items,
they are not supplied with the cable ducts*

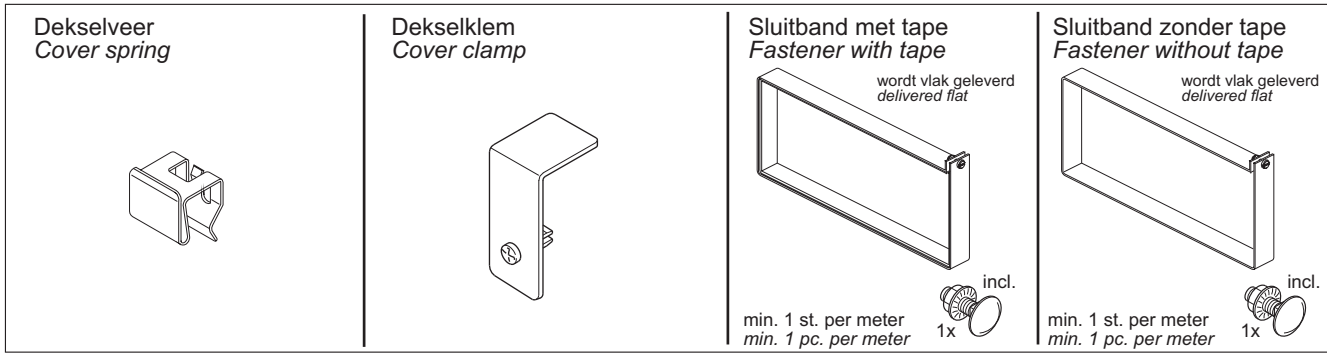

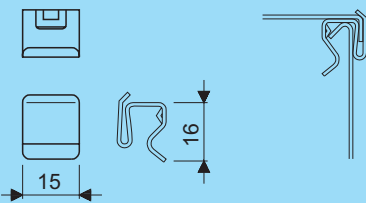

montage-toepassing
mounting application

alleen voor send.z en sendz. gelakt
only for mill galv. and mill galv./coated

Dekselveer Cover spring	
Artikel nr. Product no.	Gewicht Weight
99983.209	0,002

bestel de benodigde deksel-
veleren apart, zij worden niet
geleverd bij de deksels

*kindly order cover springs as
a separate item, they are
not supplied with the covers*

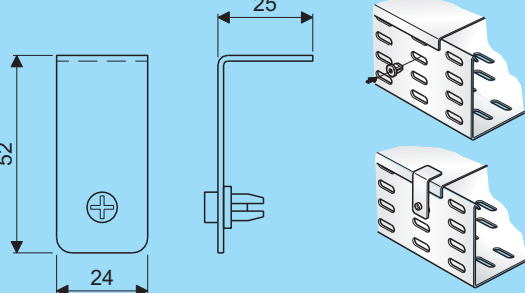

montage-toepassing
mounting application

levering inclusief
nylon plaatmoer en
bolkop Schroef
supplied complete
with plate nut and
roundhead screw

Dekselklem Cover clamp				
Artikel nr. Product no.		Artikel nr. Product no.		
Sendz.v. Mill galv.	Sendz.v. gelakt Mill galv./coated	Gewicht Weight	Therm.v. Hot dip galv.	Gewicht Weight
99984.202	99984.208	0,02	99984.203	0,02

bestel de benodigde deksel-
klemmen apart, zij worden
niet geleverd bij de deksels

*kindly order cover clamps as
a separate item, they are
not supplied with the covers*

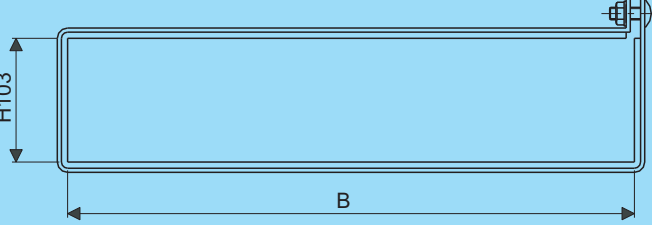

levering inclusief:
1 slotbout M6 x 12
en flensmoer

*supplied complete with:
1 lock screw M6 x 12
and flange nut*

Sluitband met tape Fastener with tape		
B	Artikel nr. Product no.	Gewicht Weight
	AISI 304	
100	34603.154	0,11
150	34604.154	0,14
200	34605.154	0,16
250	34606.154	0,19
300	34607.154	0,21

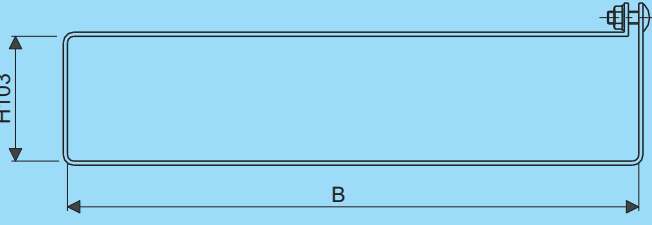

levering inclusief:
1 slotbout M6 x 12
en flensmoer

*supplied complete with:
1 lock screw M6 x 12
and flange nut*

Sluitband zonder tape Fastener without tape		
B	Artikel nr. Product no.	Gewicht Weight
	AISI 304	
100	34613.154	0,11
150	34614.154	0,14
200	34615.154	0,16
250	34616.154	0,19
300	34617.154	0,21

Koppelplaat
Splice plate

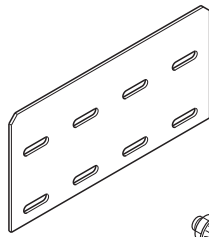

Scharnierende koppelplaat
Hinged splice plate

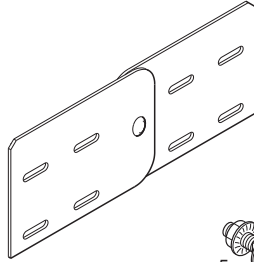

Scheidingsschot
Separation strip

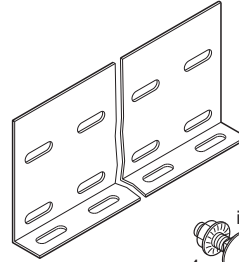

Eindschot/Verloopkoppelplaat
Endplate/Reducer splice plate

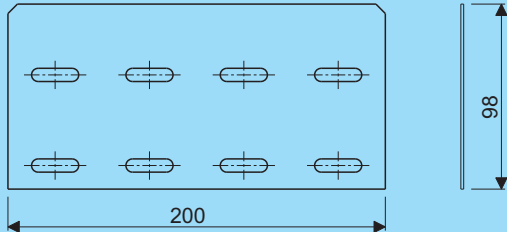
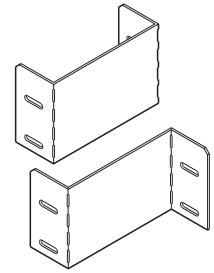

Koppelplaat
Splice plate

Artikel nr. Product no.			Artikel nr. Product no.	
Senz.v. Mill galv.	Senz.v. gelakt Mill galv./coated	Gewicht Weight	Therm.v. Hot dip galv.	Gewicht Weight
34132.152	34132.158	0,21	34132.153	0,30

levering inclusief:
4 slotbouten M6 x12
en flensmoeren

supplied complete with:
4 lock screws M6 x 12
and flange nuts

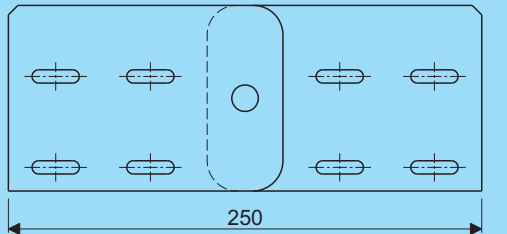

Scharnierende koppelplaat
Hinged splice plate

Artikel nr. Product no.			Artikel nr. Product no.	
Senz.v. Mill galv.	Senz.v. gelakt Mill galv./coated	Gewicht Weight	Therm.v. Hot dip galv.	Gewicht Weight
34151.152	34151.158	0,24	34151.153	0,25

levering inclusief:
5 slotbouten M6 x12
en flensmoeren

supplied complete with:
5 lock screws M6 x 12
and flange nuts

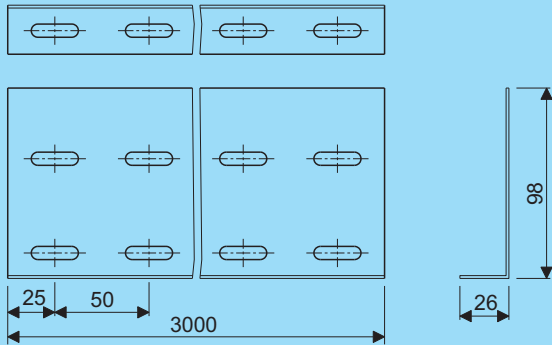

Scheidingsschot
Separation strip

Artikel nr. Product no.			Artikel nr. Product no.	
Senz.v. Mill galv.	Senz.v. gelakt Mill galv./coated	Gewicht Weight	Therm.v. Hot dip galv.	Gewicht Weight
98727.152	98727.158	2,50	98727.153	4,04

levering inclusief:
4 slotbouten M6 x12
en flensmoeren

supplied complete with:
4 lock screws M6 x 12
and flange nuts

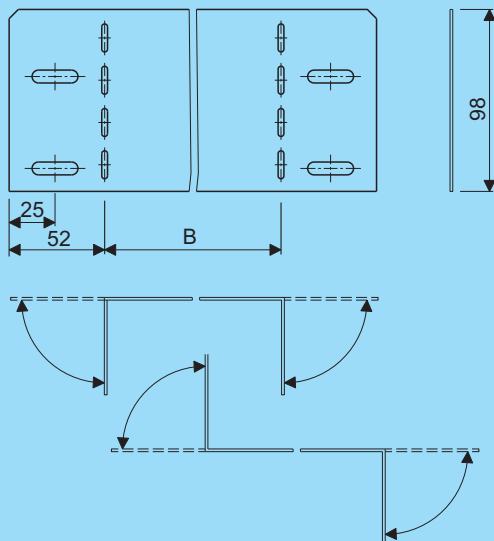

Eindschot/Verloopkoppelplaat
Endplate/Reducer splice plate

B W	Artikel nr. Product no.			Artikel nr. Product no.	
	Senz.v. Mill galv.	Senz.v. gelakt Mill galv./coated	Gewicht Weight	Therm.v. Hot dip galv.	Gewicht Weight
50	34171.152	34171.158	0,14	34171.153	0,15
100	34173.152	34173.158	0,18	34173.153	0,19
150	34174.152	34174.158	0,22	34174.153	0,23
200	34175.152	34175.158	0,26	34175.153	0,28
250	34176.152	34176.158	0,29	34176.153	0,32
300	34177.152	34177.158	0,33	34177.153	0,36

levering inclusief:
4 slotbouten M6 x12
en flensmoeren

supplied complete with:
4 lock screws M6 x 12
and flange nuts

Tray H103

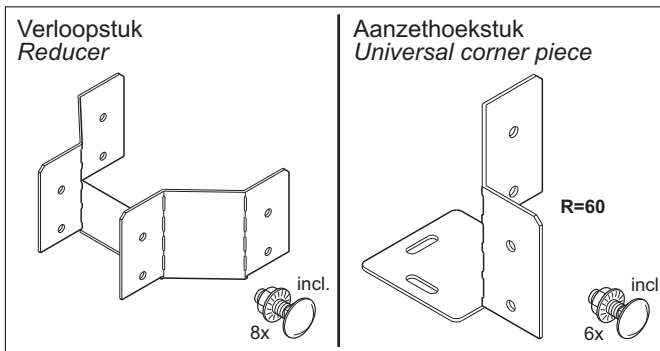

Tray

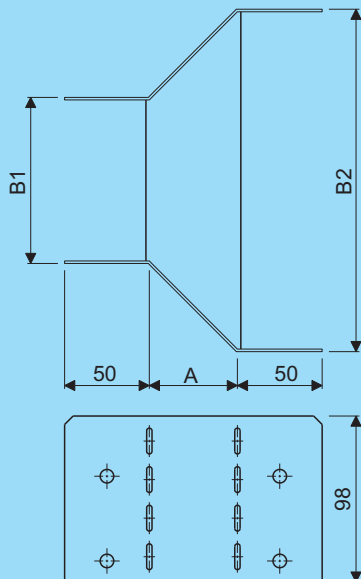

Verloopstuk Reducer						
A	B1-B2	Artikel nr. Product no.			Artikel nr. Product no.	
		Senz.v. Mill galv.	Senz.v. gelakt Mill galv./coated	Gewicht Weight	Therm.v. Hot dip galv.	Gewicht Weight
44	100-150	34197.152	34197.158	0,34	34197.153	0,36
50	100-200	34198.152	34198.158	0,39	34198.153	0,42
75	100-250	34199.152	34199.158	0,49	34199.153	0,53
44	150-200	34200.152	34200.158	0,36	34200.153	0,38
50	150-250	34201.152	34201.158	0,41	34201.153	0,44
75	150-300	34202.152	34202.158	0,52	34202.153	0,56
44	200-250	34203.152	34203.158	0,38	34203.153	0,40
50	200-300	34204.152	34204.158	0,43	34204.153	0,46
44	250-300	34206.152	34206.158	0,40	34206.153	0,42

Verloopstukdeksel Reducer cover						
A	B1-B2	Artikel nr. Product no.			Artikel nr. Product no.	
		Senz.v. Mill galv.	Senz.v. gelakt Mill galv./coated	Gewicht Weight	Therm.v. Hot dip galv.	Gewicht Weight
44	100-150	35197.142	35197.148	0,08	35197.143	0,09
50	100-200	35198.142	35198.148	0,11	35198.143	0,12
75	100-250	35199.142	35199.148	0,16	35199.143	0,18
44	150-200	35200.142	35200.148	0,11	35200.143	0,12
50	150-250	35201.142	35201.148	0,14	35201.143	0,15
75	150-300	35202.142	35202.148	0,20	35202.143	0,22
44	200-250	35203.142	35203.148	0,14	35203.143	0,15
50	200-300	35204.142	35204.148	0,17	35204.143	0,18
44	250-300	35206.142	35206.148	0,17	35206.143	0,18

levering inclusief:
8 slotbouten M6 x 12
en flensmoeren

supplied complete with:
8 lock screws M6 x 12
and flange nuts

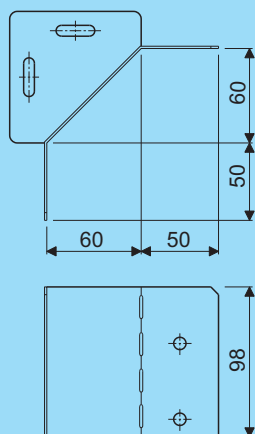

Aanzethoekstuk Universal corner piece				
Artikel nr. Product no.			Artikel nr. Product no.	
Senz.v. Mill galv.	Senz.v. gelakt Mill galv./coated	Gewicht Weight	Therm.v. Hot dip galv.	Gewicht Weight
34221.152	34221.158	0,23	34221.153	0,25

levering inclusief:
4 slotbouten M6 x 12
en flensmoeren

supplied complete with:
4 lock screws M6 x 12
and flange nuts

Tray H103

Hoekstuk 45°
Corner piece 45°

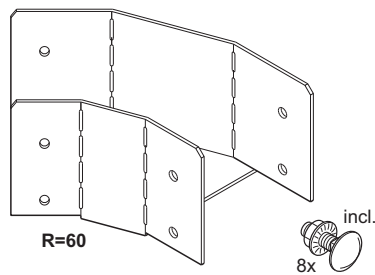

Hoekstuk 90°
Corner piece 90°

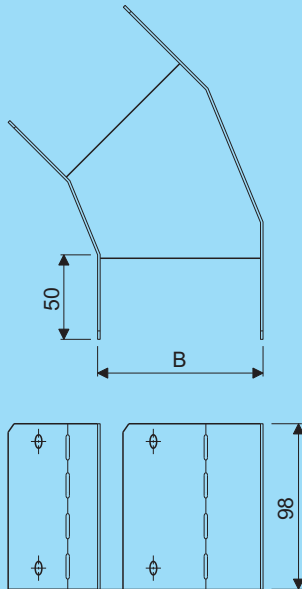
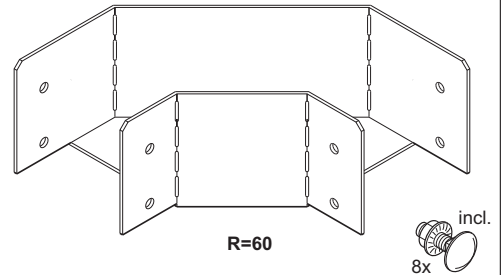

Hoekstuk 45° Corner piece 45°					
B W	Artikel nr. Product no.			Artikel nr. Product no.	
	Senz.v. Mill galv.	Senz.v. gelakt Mill galv./coated	Gewicht Weight	Therm.v. Hot dip galv.	Gewicht Weight
100	34243.152	34243.158	0,41	34243.153	0,44
150	34244.152	34244.158	0,50	34244.153	0,54
200	34245.152	34245.158	0,60	34245.153	0,65
250	34246.152	34246.158	0,72	34246.153	0,78
300	34247.152	34247.158	0,86	34247.153	0,93

Hoekstukdeksel 45° Corner piece cover 45°					
B W	Artikel nr. Product no.			Artikel nr. Product no.	
	Senz.v. Mill galv.	Senz.v. gelakt Mill galv./coated	Gewicht Weight	Therm.v. Hot dip galv.	Gewicht Weight
100	35243.142	35243.148	0,10	35243.143	0,11
150	35244.142	35244.148	0,17	35244.143	0,19
200	35245.142	35245.148	0,26	35245.143	0,28
250	35246.142	35246.148	0,36	35246.143	0,40
300	35247.142	35247.148	0,48	35247.143	0,52

levering inclusief:
8 slotbouten M6 x 12
en flensmoeren

supplied complete with:
8 lock screws M6 x 12
and flange nuts

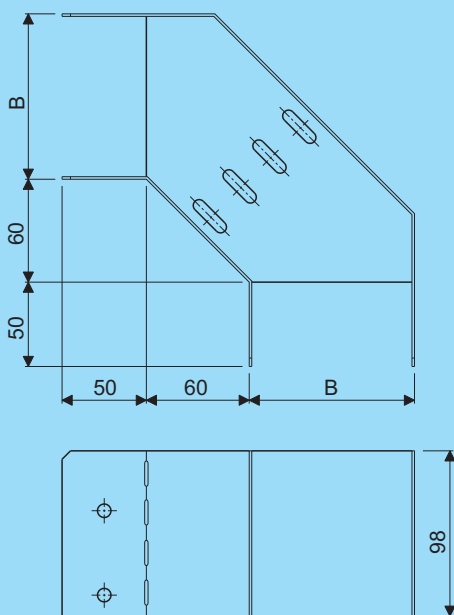

Hoekstuk 90° Corner piece 90°					
B W	Artikel nr. Product no.			Artikel nr. Product no.	
	Senz.v. Mill galv.	Senz.v. gelakt Mill galv./coated	Gewicht Weight	Therm.v. Hot dip galv.	Gewicht Weight
100	34263.152	34263.158	0,59	34263.153	0,63
150	34264.152	34264.158	0,76	34264.153	0,82
200	34265.152	34265.158	0,97	34265.153	1,05
250	34266.152	34266.158	1,22	34266.153	1,32
300	34267.152	34267.158	1,49	34267.153	1,62

Hoekstukdeksel 90° Corner piece cover 90°					
B W	Artikel nr. Product no.			Artikel nr. Product no.	
	Senz.v. Mill galv.	Senz.v. gelakt Mill galv./coated	Gewicht Weight	Therm.v. Hot dip galv.	Gewicht Weight
100	35263.142	35263.148	0,18	35263.143	0,20
150	35264.142	35264.148	0,32	35264.143	0,35
200	35265.142	35265.148	0,50	35265.143	0,54
250	35266.142	35266.148	0,67	35266.143	0,73
300	35267.142	35267.148	0,87	35267.143	0,97

levering inclusief:
8 slotbouten M6 x 12
en flensmoeren

supplied complete with:
8 lock screws M6 x 12
and flange nuts

Tray H103

Aftakstuk
Branch

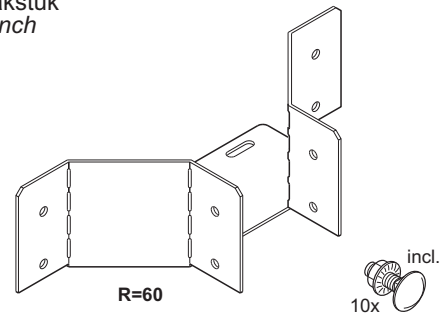

Tray

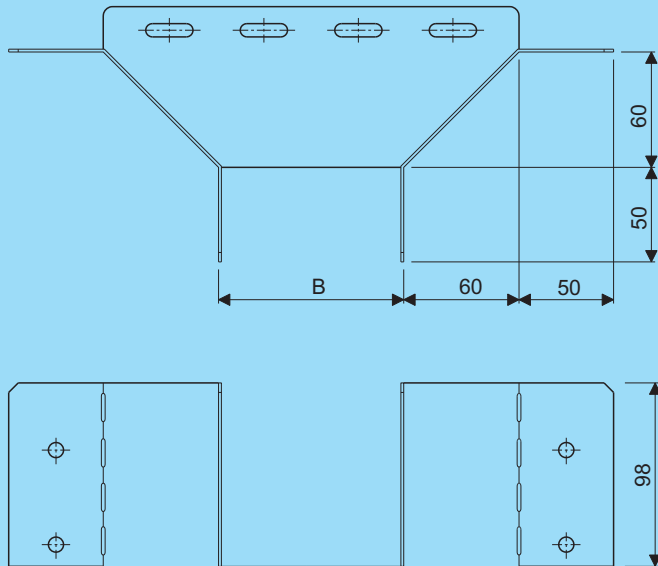

Aftakstuk Branch					
B W	Artikel nr. Product no.			Artikel nr. Product no.	
	Senz.v. Mill galv.	Senz.v. gelakt Mill galv./coated	Gewicht Weight	Therm.v. Hot dip galv.	Gewicht Weight
100	34283.152	34283.158	0,50	34283.153	0,54
150	34284.152	34284.158	0,64	34284.153	0,69
200	34285.152	34285.158	0,83	34285.153	0,89
250	34286.152	34286.158	1,05	34286.153	1,14
300	34287.152	34287.158	1,31	34287.153	1,42

Aftakstukdeksel Branch cover					
B W	Artikel nr. Product no.			Artikel nr. Product no.	
	Senz.v. Mill galv.	Senz.v. gelakt Mill galv./coated	Gewicht Weight	Therm.v. Hot dip galv.	Gewicht Weight
100	35283.142	35283.148	0,12	35283.143	0,13
150	35284.142	35284.148	0,18	35284.143	0,19
200	35285.142	35285.148	0,19	35285.143	0,21
250	35286.142	35286.148	0,24	35286.143	0,26
300	35287.142	35287.148	0,27	35287.143	0,29

levering inclusief:
8 slotbouten M6 x 12
en flensmoeren

supplied complete with:
8 lock screws M6 x 12
and flange nuts

Tray H103

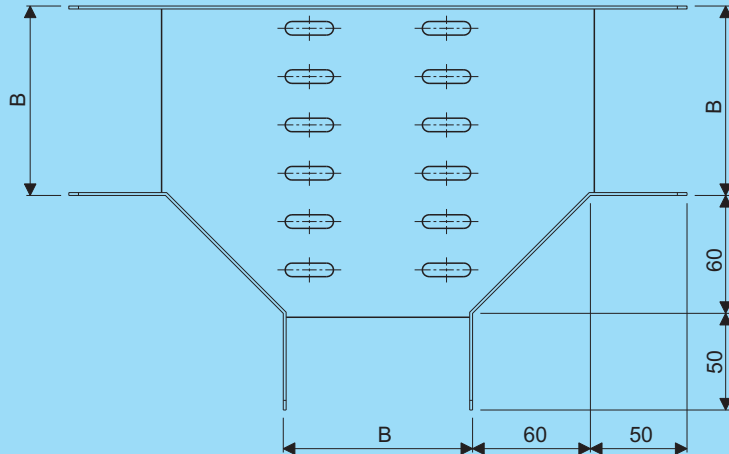
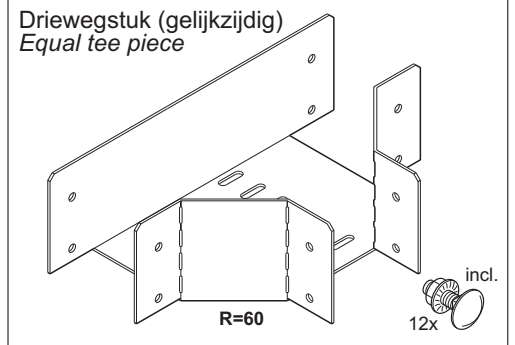

Driewegstuk (gelijkzijdig) Equal tee piece					
B W	Artikel nr. Product no.			Artikel nr. Product no.	
	Sendz.v. Mill galv.	Sendz.v. gelakt Mill galv./coated	Gewicht Weight	Therm.v. Hot dip galv.	Gewicht Weight
100	34303.152	34303.158	0,85	34303.153	0,92
150	34304.152	34304.158	1,06	34304.153	1,14
200	34305.152	34305.158	1,30	34305.153	1,41
250	34306.152	34306.158	1,59	34306.153	1,72
300	34307.152	34307.158	1,91	34307.153	2,07

Driewegstukdeksel (gelijkzijdig) Equal tee piece cover					
B W	Artikel nr. Product no.			Artikel nr. Product no.	
	Sendz.v. Mill galv.	Sendz.v. gelakt Mill galv./coated	Gewicht Weight	Therm.v. Hot dip galv.	Gewicht Weight
100	35303.142	35303.148	0,31	35303.143	0,34
150	35304.142	35304.148	0,50	35304.143	0,55
200	35305.142	35305.148	0,74	35305.143	0,81
250	35306.142	35306.148	1,02	35306.143	1,11
300	35307.142	35307.148	1,33	35307.143	1,45

levering inclusief:
12 slotbouten M6 x 12
en flensmoeren

supplied complete with:
12 lock screws M6 x 12
and flange nuts

Tray H103

Driewegstuk (ongelijkzijdig)
Unequal tee piece (reducing)

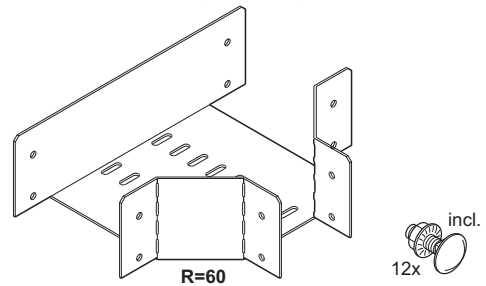

Tray

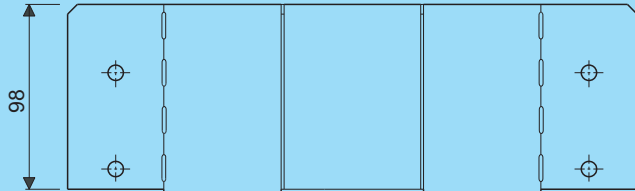
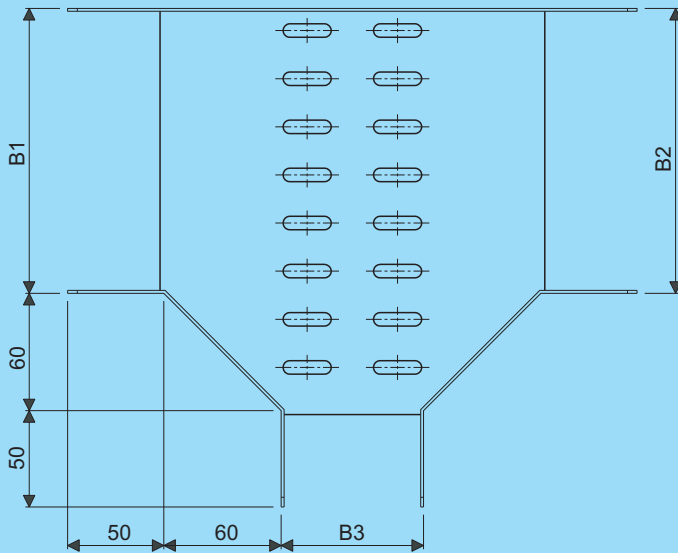

Driewegstuk (ongelijkzijdig) Unequal tee piece (reducing)						Driewegstukdeksel (ongelijkzijdig) Unequal tee piece cover (reducing)				
B1-B2-B3	Artikel nr. Product no.			Artikel nr. Product no.		Artikel nr. Product no.			Artikel nr. Product no.	
	Senz.v. Mill galv.	Senz.v. gelakt Mill galv./coated	Gewicht Weight	Therm.v. Hot dip galv.	Gewicht Weight	Senz.v. Mill galv.	Senz.v. gelakt Mill galv./coated	Gewicht Weight	Therm.v. Hot dip galv.	Gewicht Weight
150-150-100	34326.152	34326.158	0,93	34326.153	1,01	35326.142	35326.148	0,20	35326.143	0,22
200-200-100	34329.152	34329.158	1,02	34329.153	1,10	35329.142	35329.148	0,24	35329.143	0,27
200-200-150	34330.152	34330.158	1,16	34330.153	1,25	35330.142	35330.148	0,27	35330.143	0,29
250-250-100	34333.152	34333.158	1,10	34333.153	1,19	35333.142	35333.148	0,32	35333.143	0,35
250-250-150	34334.152	34334.158	1,26	34334.153	1,36	35334.142	35334.148	0,37	35334.143	0,40
250-250-200	34335.152	34335.158	1,42	34335.153	1,54	35335.142	35335.148	0,42	35335.143	0,45
300-300-100	34338.152	34338.158	1,18	34338.153	1,27	35338.142	35338.148	0,40	35338.143	0,44
300-300-150	34339.152	34339.158	1,36	34339.153	1,47	35339.142	35339.148	0,46	35339.143	0,50
300-300-200	34340.152	34340.158	1,54	34340.153	1,67	35340.142	35340.148	0,52	35340.143	0,56
300-300-250	34341.152	34341.158	1,73	34341.153	1,87	35341.142	35341.148	0,63	35341.143	0,69

levering inclusief:
12 slotbouten M6 x 12
en flensmoeren

supplied complete with:
12 lock screws M6 x 12
and flange nuts

Tray H103

Driewegstuk (ongelijkzijdig)
Unequal tee piece (expanding)

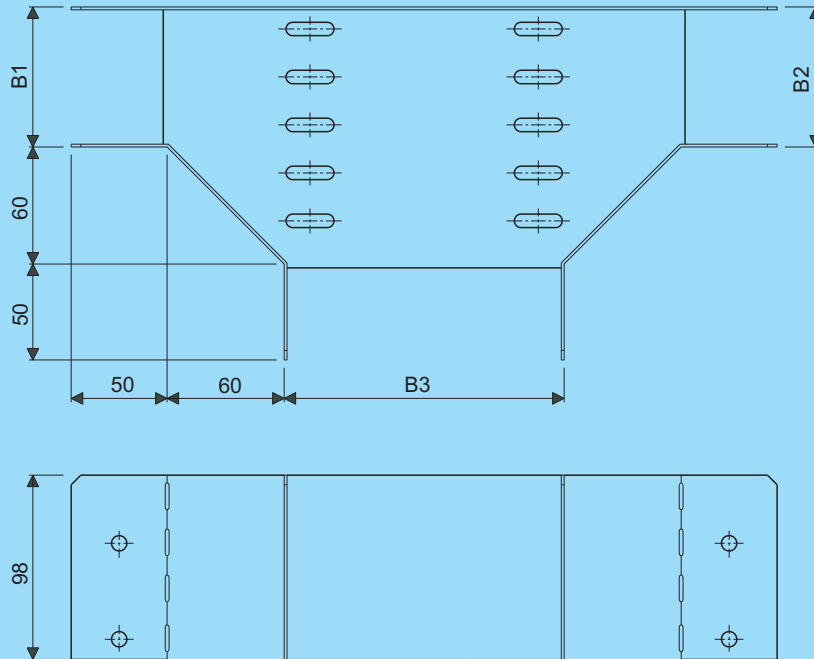
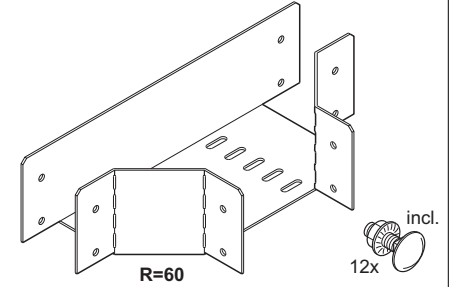

Driewegstuk (ongelijkzijdig) Unequal tee piece (expanding)						Driewegstukdeksel (ongelijkzijdig) Unequal tee piece cover (expanding)				
B1-B2-B3	Artikel nr. Product no.			Artikel nr. Product no.		Artikel nr. Product no.			Artikel nr. Product no.	
	Sendz.v. Mill galv.	Sendz.v. gelakt Mill galv./coated	Gewicht Weight	Therm.v. Hot dip galv.	Gewicht Weight	Sendz.v. Mill galv.	Sendz.v. gelakt Mill galv./coated	Gewicht Weight	Therm.v. Hot dip galv.	Gewicht Weight
100-100-150	34372.152	34372.158	0,96	34372.153	1,03	35372.142	35372.148	0,52	35372.143	0,43
100-100-200	34373.152	34373.158	1,06	34373.153	1,15	35373.142	35373.148	0,39	35373.143	0,51
100-100-250	34374.152	34374.158	1,16	34374.153	1,26	35374.142	35374.148	0,46	35374.143	0,59
100-100-300	34375.152	34375.158	1,27	34375.153	1,37	35375.142	35375.148	0,54	35375.143	0,67
150-150-200	34376.152	34376.158	1,18	34376.153	1,28	35376.142	35376.148	0,61	35376.143	0,66
150-150-250	34377.152	34377.158	1,30	34377.153	1,41	35377.142	35377.148	0,60	35377.143	0,76
150-150-300	34378.152	34378.158	1,43	34378.153	1,55	35378.142	35378.148	0,70	35378.143	0,86
200-200-250	34379.152	34379.158	1,45	34379.153	1,57	35379.142	35379.148	0,79	35379.143	0,94
200-200-300	34380.152	34380.158	1,59	34380.153	1,72	35380.142	35380.148	0,86	35380.143	1,06
250-250-300	34381.152	34381.158	1,75	34381.153	1,90	35381.142	35381.148	0,97	35381.143	1,26

supplied complete with:
12 lock screws M6 x 12
and flange nuts

levering inclusief:
12 slotbouten M6 x 12
en flensmoeren

Tray H103

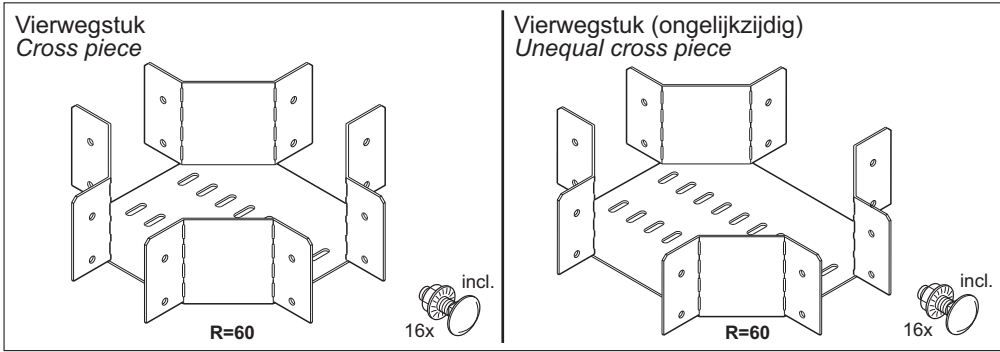

Tray

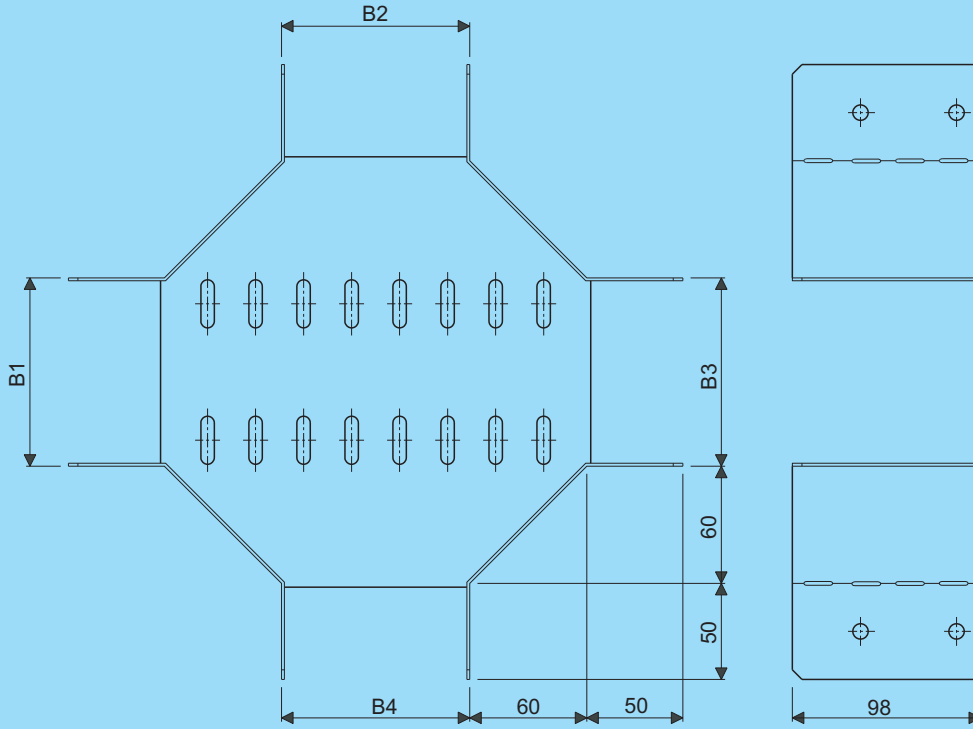

Vierwegstuk Cross piece						Vierwegstukdeksel Cross piece cover				
B1-B2-B3-B4	Artikel nr. Product no.			Artikel nr. Product no.		Artikel nr. Product no.			Artikel nr. Product no.	
	Senz.v. Mill galv.	Senz.v. gelakt Mill galv./coated	Gewicht Weight	Therm.v. Hot dip galv.	Gewicht Weight	Senz.v. Mill galv.	Senz.v. gelakt Mill galv./coated	Gewicht Weight	Therm.v. Hot dip galv.	Gewicht Weight
100-100-100-100	34403.152	34403.158	1,00	34403.153	1,07	35403.142	35403.148	0,22	35403.143	0,24
150-150-150-150	34404.152	34404.158	1,18	34404.153	1,28	35404.142	35404.148	0,29	35404.143	0,31
200-200-200-200	34405.152	34405.158	1,41	34405.153	1,53	35405.142	35405.148	0,40	35405.143	0,44
250-250-250-250	34406.152	34406.158	1,68	34406.153	1,82	35406.142	35406.148	0,58	35406.143	0,64
300-300-300-300	34407.152	34407.158	1,99	34407.153	2,16	35407.142	35407.148	0,88	35407.143	0,96
150-100-150-100	34426.152	34426.158	1,08	34426.153	1,16	35426.142	35426.148	1,18	35426.143	1,29
200-100-200-100	34429.152	34429.158	1,16	34429.153	1,25	35429.142	35429.148	1,52	35429.143	1,66
200-150-200-150	34430.152	34430.158	1,28	34430.153	1,39	35430.142	35430.148	0,26	35430.143	0,28
250-100-250-100	34433.152	34433.158	1,24	34433.153	1,34	35433.142	35433.148	0,30	35433.143	0,33
250-150-250-150	34434.152	34434.158	1,38	34434.153	1,50	35434.142	35434.148	0,35	35434.143	0,38
250-200-250-200	34435.152	34435.158	1,53	34435.153	1,66	35435.142	35435.148	0,38	35435.143	0,41
300-100-300-100	34438.152	34438.158	1,32	34438.153	1,42	35438.142	35438.148	0,44	35438.143	0,48
300-150-300-150	34439.152	34439.158	1,49	34439.153	1,61	35439.142	35439.148	0,50	35439.143	0,55
300-200-300-200	34440.152	34440.158	1,65	34440.153	1,79	35440.142	35440.148	0,46	35440.143	0,50
300-250-300-250	34441.152	34441.158	1,82	34441.153	1,97	35441.142	35441.148	0,53	35441.143	0,58

levering inclusief:
16 slotbouten M6 x 12
en flensmoeren

supplied complete with:
16 lock screws M6 x 12
and flange nuts

Tray H103

Stijgstuk 45°
Vertical inner bend 45°

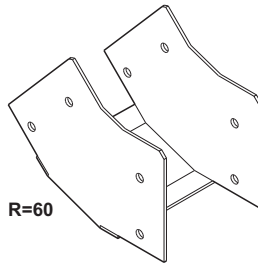

Stijgstuk 90°
Vertical inner bend 90°

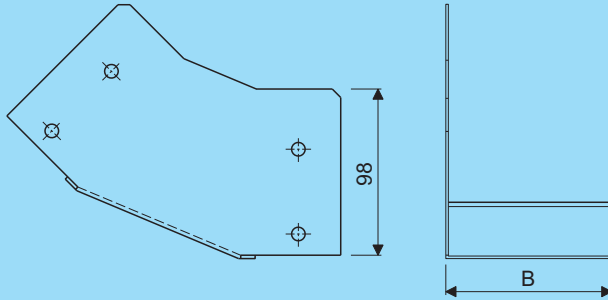
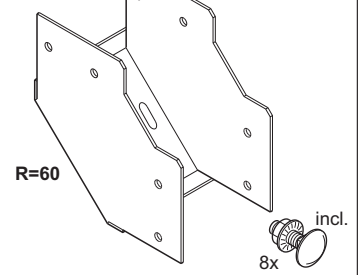

Stijgstuk 45° Vertical inner bend 45°					
B W	Artikel nr. Product no.			Artikel nr. Product no.	
	Senz.v. Mill galv.	Senz.v. gelakt Mill galv./coated	Gewicht Weight	Therm.v. Hot dip galv.	Gewicht Weight
100	34463.152	34463.158	0,44	34463.153	0,48
150	34464.152	34464.158	0,49	34464.153	0,53
200	34465.152	34465.158	0,54	34465.153	0,58
250	34466.152	34466.158	0,59	34466.153	0,64
300	34467.152	34467.158	0,64	34467.153	0,69

Stijgstukdeksel 45° Vertical inner bend cover 45°				
Artikel nr. Product no.			Artikel nr. Product no.	
Senz.v. Mill galv.	Senz.v. gelakt Mill galv./coated	Gewicht Weight	Therm.v. Hot dip galv.	Gewicht Weight
35463.142	35463.148	0,07	35463.143	0,07
35464.142	35464.148	0,10	35464.143	0,11
35465.142	35465.148	0,13	35465.143	0,14
35466.142	35466.148	0,15	35466.143	0,17
35467.142	35467.148	0,19	35467.143	0,21

levering inclusief:
8 slotbouten M6 x 12
en flensmoeren

supplied complete with:
8 lock screws M6 x 12
and flange nuts

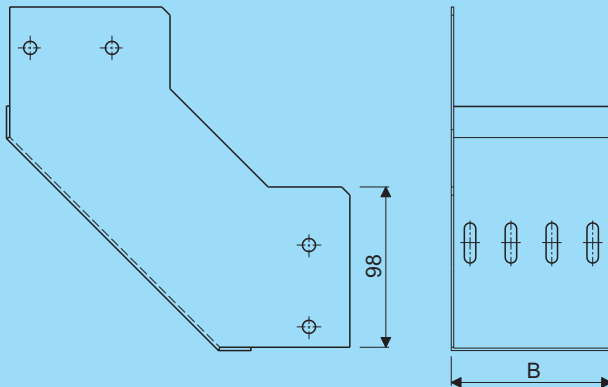

Stijgstuk 90° Vertical inner bend 90°					
B W	Artikel nr. Product no.			Artikel nr. Product no.	
	Senz.v. Mill galv.	Senz.v. gelakt Mill galv./coated	Gewicht Weight	Therm.v. Hot dip galv.	Gewicht Weight
100	34483.152	34483.158	0,65	34483.153	0,71
150	34484.152	34484.158	0,75	34484.153	0,81
200	34485.152	34485.158	0,85	34485.153	0,92
250	34486.152	34486.158	0,94	34486.153	1,02
300	34487.152	34487.158	1,04	34487.153	1,12

Stijgstukdeksel 90° Vertical inner bend cover 90°				
Artikel nr. Product no.			Artikel nr. Product no.	
Senz.v. Mill galv.	Senz.v. gelakt Mill galv./coated	Gewicht Weight	Therm.v. Hot dip galv.	Gewicht Weight
35483.142	35483.148	0,10	35483.143	0,11
35484.142	35484.148	0,15	35464.143	0,16
35485.142	35485.148	0,20	35485.143	0,21
35486.142	35486.148	0,23	35486.143	0,25
35487.142	35487.148	0,29	35487.143	0,31

levering inclusief:
8 slotbouten M6 x 12
en flensmoeren

supplied complete with:
8 lock screws M6 x 12
and flange nuts

Tray H103

Vervalstuk 45°
Vertical outer bend 45°

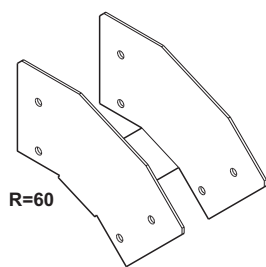

incl.
8x

Vervalstuk 90°
Vertical outer bend 90°

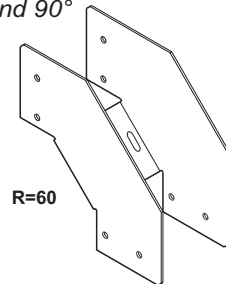

incl.
8x

Tray

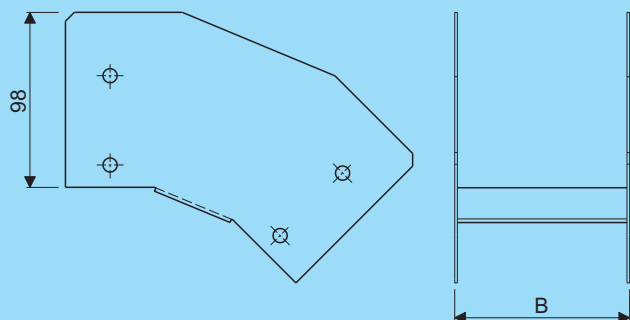

Vervalstuk 45° Vertical outer bend 45°						Vervalstukdeksel 45° Vertical outer bend cover 45°				
B W	Artikel nr. Product no.			Artikel nr. Product no.		Artikel nr. Product no.			Artikel nr. Product no.	
	Senz.v. Mill galv.	Senz.v. gelakt Mill galv./coated	Gewicht Weight	Therm.v. Hot dip galv.	Gewicht Weight	Senz.v. Mill galv.	Senz.v. gelakt Mill galv./coated	Gewicht Weight	Therm.v. Hot dip galv.	Gewicht Weight
100	34503.152	34503.158	0,39	34503.153	0,41	35643.142	35643.148	0,12	35643.143	0,13
150	34504.152	34504.158	0,40	34504.153	0,43	35644.142	35644.148	0,18	35644.143	0,20
200	34505.152	34505.158	0,42	34505.153	0,45	35645.142	35645.148	0,25	35645.143	0,27
250	34506.152	34506.158	0,44	34506.153	0,47	35646.142	35646.148	0,31	35646.143	0,34
300	34507.152	34507.158	0,46	34507.153	0,49	35647.142	35647.148	0,37	35647.143	0,41

levering inclusief:
8 slotbouten M6 x 12
en flensmoeren

supplied complete with:
8 lock screws M6 x 12
and flange nuts

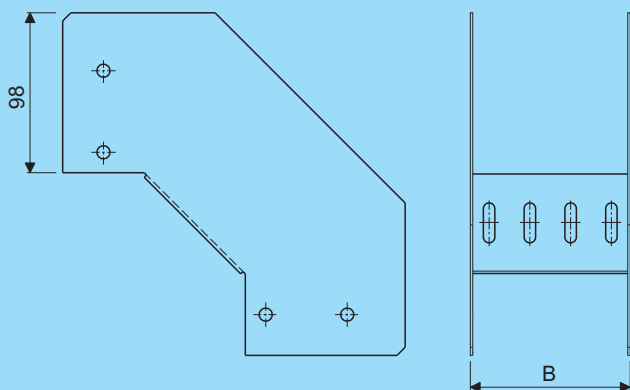

Vervalstuk 90° Vertical outer bend 90°						Vervalstukdeksel 90° Vertical outer bend cover 90°				
B W	Artikel nr. Product no.			Artikel nr. Product no.		Artikel nr. Product no.			Artikel nr. Product no.	
	Senz.v. Mill galv.	Senz.v. gelakt Mill galv./coated	Gewicht Weight	Therm.v. Hot dip galv.	Gewicht Weight	Senz.v. Mill galv.	Senz.v. gelakt Mill galv./coated	Gewicht Weight	Therm.v. Hot dip galv.	Gewicht Weight
100	34523.152	34523.158	0,53	34523.153	0,57	35663.142	35663.148	0,22	35663.143	0,24
150	34524.152	34524.158	0,56	34524.153	0,60	35664.142	35664.148	0,33	35664.143	0,37
200	34525.152	34525.158	0,59	34525.153	0,63	35665.142	35665.148	0,45	35665.143	0,49
250	34526.152	34526.158	0,62	34526.153	0,67	35666.142	35666.148	0,56	35666.143	0,61
300	34527.152	34527.158	0,65	34527.153	0,70	35667.142	35667.148	0,67	35667.143	0,73

levering inclusief:
8 slotbouten M6 x 12
en flensmoeren

supplied complete with:
8 lock screws M6 x 12
and flange nuts