

STRUT

STRUT MONTAGE SYSTEEM

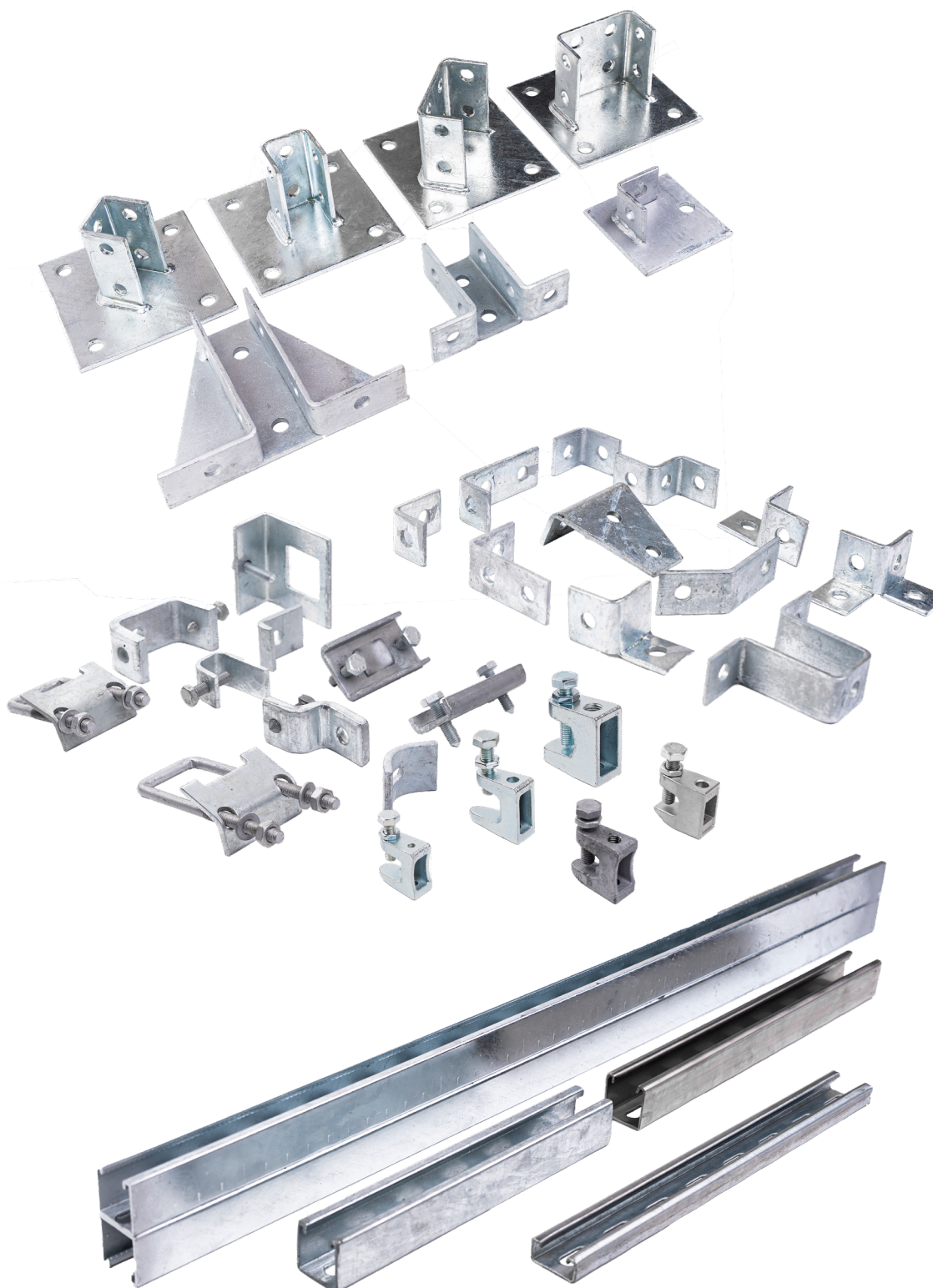

Index

Staal

- E** Staal, elektrolytisch verzinkt
- S** Staal, sendzimir verzinkt volgens EN 10327
- ZM** Zink Magnesium ZM310
- V** Staal, volbad thermisch verzinkt volgens EN ISO 1461



Roestvast staal

- R2** Roestvast staal 304/A2
- R4** Roestvast staal 316/A4

Kunststof

- K** Kunststof



Aanvullende productinformatie

In deze PDF kunt u door op artikelnummers klikken, het betreffende product bekijken in ons **online productenportaal**. Daar vindt u aanvullende informatie en technische specificaties.

Via onderstaande knop opent u het volledige productenportaal.

Gouda Holland B.V.
Grote Esch 80
2841 MJ Moordrecht

Tel.: +31 (0) 18 250 62 00

info@goudaholland.nl
www.goudaholland.nl



Inhoud

Fig.	Producten	Paginanummer
NX0 - Railprofielen		
1	NX0010 Railprofiel	GH4 - GH6
2	NX0020 Railprofiel, geperforeerd	GH4
3	NX0030 Railprofiel, geperforeerd	GH4
4	NX0040 Railprofiel	GH5
5	NX0050 / NX0060 Railprofiel, geperforeerd	GH5
6	NX0070 Railprofiel, geperforeerd	GH5
7	NX0080 Railprofiel	GH5
8	NX0090 / NX0100 Railprofiel, geperforeerd	GH5
9	NX0110 Railprofiel, geperforeerd	GH6
NX1 - Vlakke platen		
10	NX1040 Vlakke plaat	GH7 - GH8
NX2 - Montagehoeken		
11	NX2050 Montagehoek	GH9 - GH11
12	NX2150 Montagehoek 135°	GH9
NX3 - U en Z beugels		
13	NX3010 Z - beugel	GH13 - GH14
14	NX3020 Z - beugel	GH13
NX4 - Koppelstukken		
15	NX4010 Koppelstuk extern	GH15
16	NX4030 Koppelstuk intern	GH15
NX5 - Voetplaten en vleugelstukken		
17	NX5010 Voetplaat	GH17 - GH18
18	NX5030 Vleugelstuk	GH17
NX6 - Balkklemmen		
NX7 - Glijmoeren en hamerkopbouten		
19	NX7110 Glijmoer met lange veer	GH23 - GH24
NX8 - Eindkappen en deksels		
20	NX8020K Eindkap, inwendig	GH25
NX9 - Consoles		
Bevestigingsmateriaal		
		GH27 - GH28
		GH29 - GH32

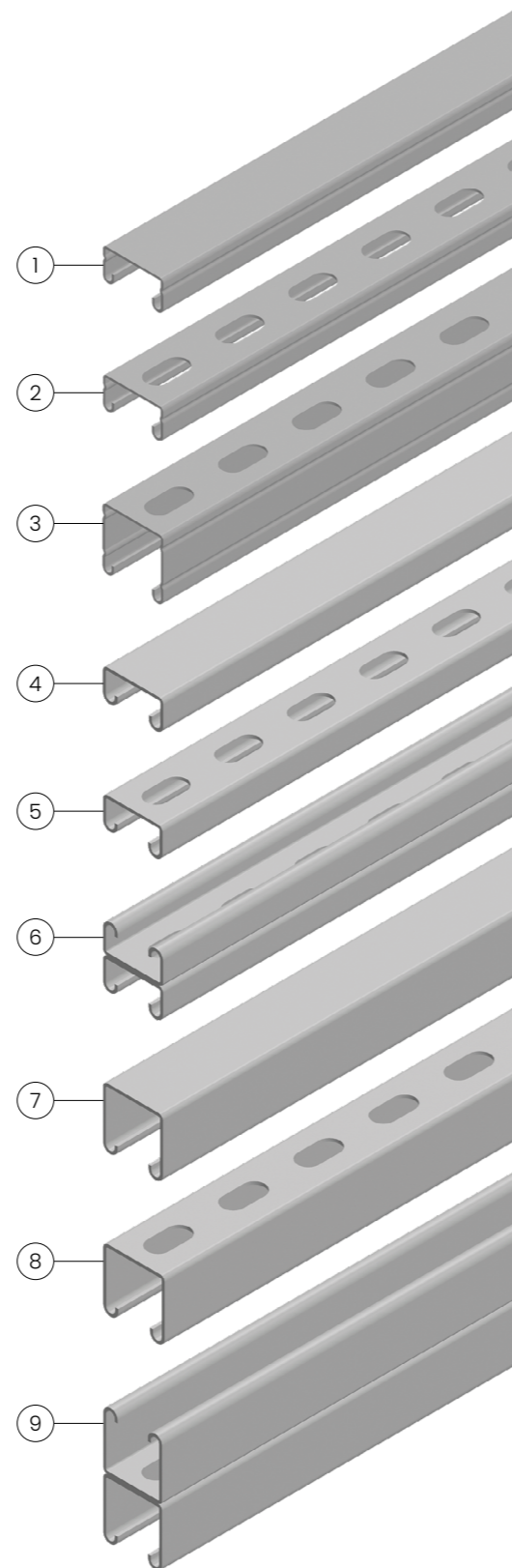

Overzicht railprofielen

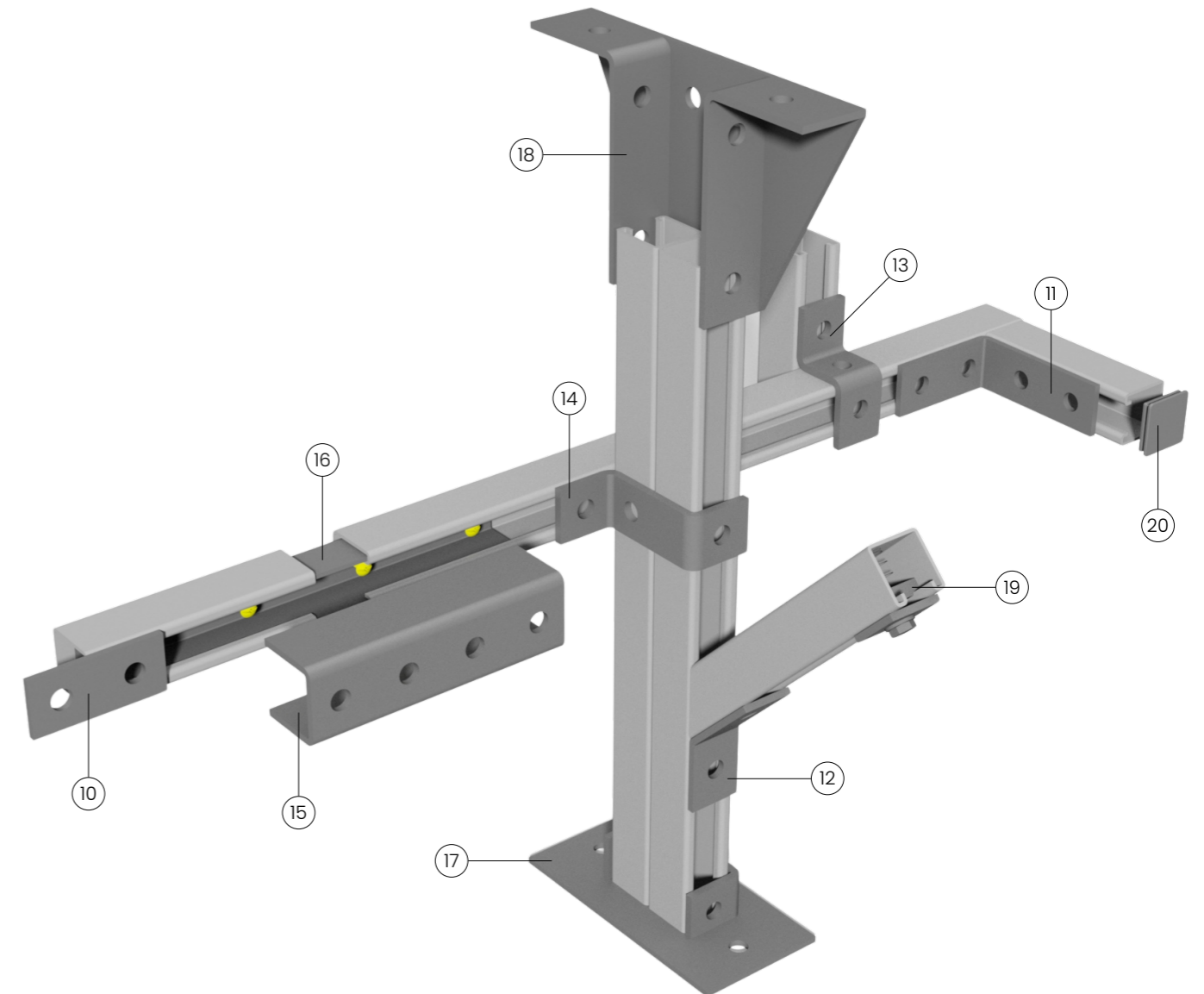

Overzicht Strut onderdelen

NX0 - Railprofielen

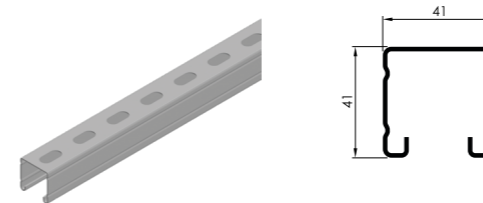
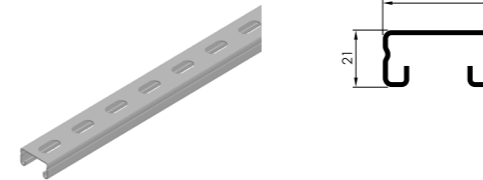
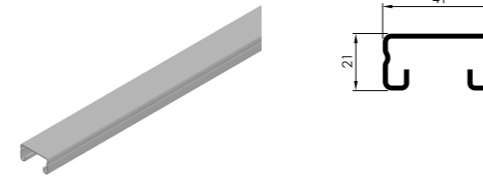

Typenummer	B x H mm	Artikel nummer	Materiaal dikte mm	kg m	VPE	Kortings groep
------------	----------	----------------	--------------------	------	-----	----------------

Railprofiel						
S NX0010S	41 x 21	98980202	1,5	1,21	6 m	MG

Railprofiel, geperforeerd						
S NX0020S	41 x 21	98982202	1,5	1,05	6 m	MG

Railprofiel, geperforeerd						
S NX0030S	41 x 41	98984202	1,5	1,48	6 m	MG

NX0 - Railprofielen

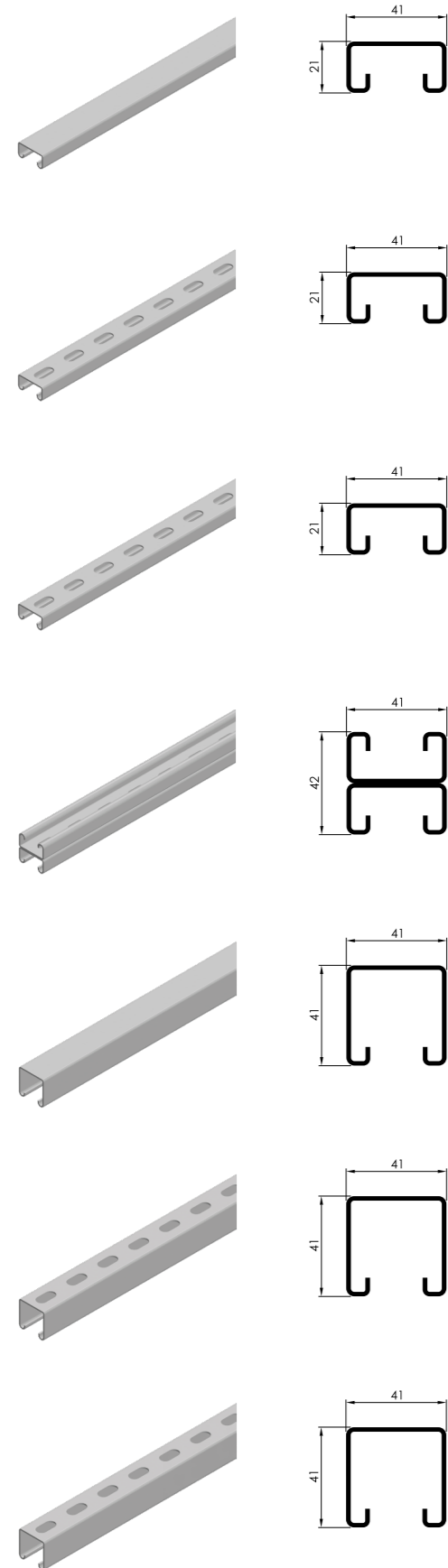

Typenummer	B x H mm	Artikel nummer	Materiaal dikte mm	kg m	VPE	Kortings groep
Railprofiel						
S NX0040S	41 x 21	98986202	2,5	1,72	6 m	MG
V NX0040V	41 x 21	98986203	2,5	1,90	6 m	MG
R4 NX0040R4	41 x 21	98986206	2,5	1,72	6 m	MG
Railprofiel, geperforeerd						
S NX0050S	41 x 21	98027202	2,5	1,63	6 m	MG
ZM NX0050ZM	41 x 21	98027208	2,5	1,63	6 m	MG
V NX0050V	41 x 21	98027203	2,5	1,76	6 m	MG
R2 NX0050R2	41 x 21	98027204	2,5	1,63	6 m	MG
R4 NX0050R4	41 x 21	98027206	2,5	1,63	6 m	MG
Railprofiel, geperforeerd						
S NX0060S	41 x 21	98026202	2,5	1,63	3 m	MG
V NX0060V	41 x 21	98026203	2,5	1,76	3 m	MG
R2 NX0060R2	41 x 21	98026204	2,5	1,63	3 m	MG
R4 NX0060R4	41 x 21	98026206	2,5	1,63	3 m	MG
Railprofiel, geperforeerd						
S NX0070S	41 x 42	98028202	2,5	3,40	6 m	MG
V NX0070V	41 x 42	98028203	2,5	3,53	6 m	MG
R4 NX0070R4	41 x 42	98028206	2,5	3,40	6 m	MG
Railprofiel						
S NX0080S	41 x 41	98988202	2,5	2,68	6 m	MG
V NX0080V	41 x 41	98988203	2,5	2,88	6 m	MG
R4 NX0080R4	41 x 41	98988206	2,5	2,68	6 m	MG
Railprofiel, geperforeerd						
S NX0090S	41 x 41	98057202	2,5	2,55	6 m	MG
ZM NX0090ZM	41 x 41	98057208	2,5	2,55	6 m	MG
V NX0090V	41 x 41	98057203	2,5	2,68	6 m	MG
R2 NX0090R2	41 x 41	98057204	2,5	2,55	6 m	MG
R4 NX0090R4	41 x 41	98057206	2,5	2,55	6 m	MG
Railprofiel, geperforeerd						
S NX0100S	41 x 41	98056202	2,5	2,55	3 m	MG
V NX0100V	41 x 41	98056203	2,5	2,68	3 m	MG
R2 NX0100R2	41 x 41	98056204	2,5	2,55	3 m	MG
R4 NX0100R4	41 x 41	98056206	2,5	2,55	3 m	MG

NX0 - Railprofielen

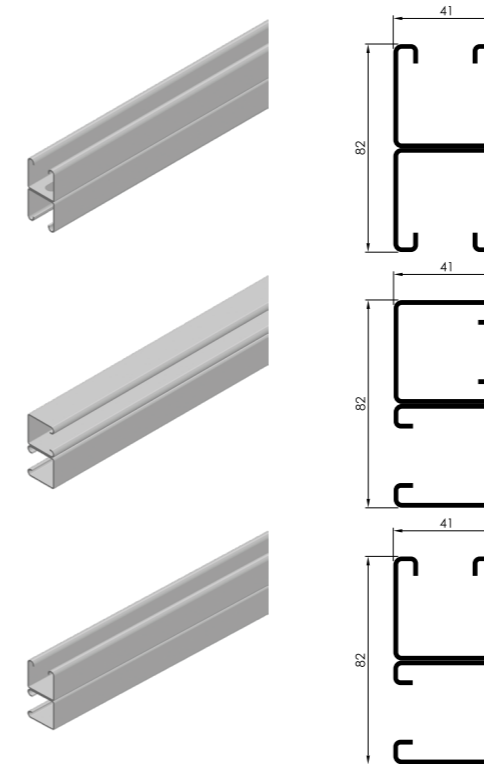

Typenummer	B x H mm	Artikel nummer	Materiaal dikte mm	kg m	VPE	Kortings groep
Railprofiel, geperforeerd						
S NX0110S	41 x 82	98058202	2,5	5,20	6 m	MG
V NX0110V	41 x 82	98058203	2,5	5,43	6 m	MG
R4 NX0110R4	41 x 82	98058206	2,5	5,20	6 m	MG
Railprofiel						
V NX0120V	41 x 82	98990203	2,5	5,70	6 m	MG
Railprofiel						
V NX0130V	41 x 82	98992203	2,5	5,70	6 m	MG

NX1 - Vlakke platen

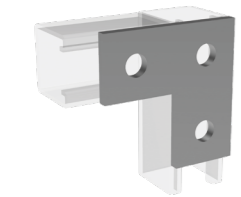
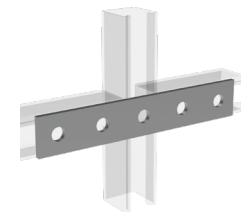
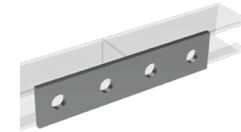
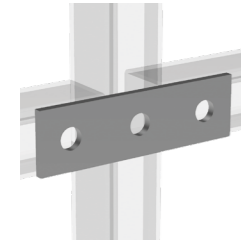
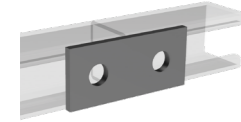
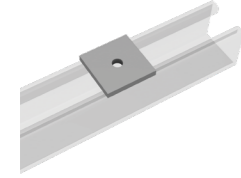

Typenummer	Gatmaat ø mm	Artikel nummer	Materiaal dikte mm	kg stuk	VPE	Kortings groep
------------	-----------------	-------------------	--------------------------	------------	-----	-------------------

Vlakke plaat						
V	NX1000V	8	98075203	5	0,07	100 st. MG
	NX1010V	10	98076203	5	0,07	100 st. MG
	NX1020V	12	98077203	5	0,07	100 st. MG
	NX1030V	14	98078203	5	0,07	100 st. MG
R4	NX1000R4	8	98075206	5	0,06	100 st. MG
	NX1010R4	10	98076206	5	0,06	100 st. MG
	NX1020R4	12	98077206	5	0,06	100 st. MG
	NX1030R4	14	98078206	5	0,06	100 st. MG

Vlakke plaat						
V	NX1040V	14	98101203	5	0,15	25 st. MG
R4	NX1040R4	14	98101206	5	0,13	25 st. MG

Vlakke plaat						
V	NX1050V	14	98103203	5	0,23	25 st. MG
R4	NX1050R4	14	98103206	5	0,20	25 st. MG

Vlakke plaat						
V	NX1060V	14	98105203	5	0,30	25 st. MG
R4	NX1060R4	14	98105206	5	0,27	25 st. MG

Vlakke plaat						
V	NX1070V	14	98107203	5	0,36	25 st. MG
R4	NX1070R4	14	98107206	5	0,34	25 st. MG

Vlakke plaat						
V	NX1080V	14	98140203	5	0,22	25 st. MG
R4	NX1080R4	14	98140206	5	0,20	25 st. MG

NX1 - Vlakke platen

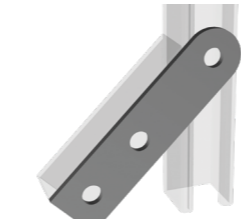
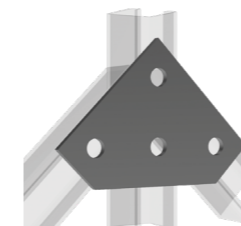
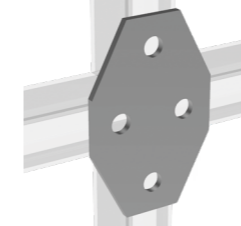
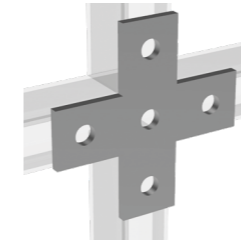
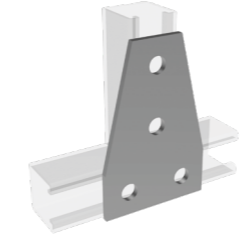
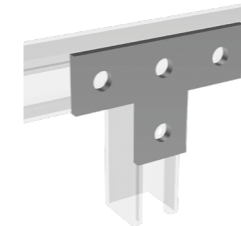

Typenummer	Gatmaat ø mm	Artikel nummer	Materiaal dikte mm	kg stuk	VPE	Kortings groep
------------	-----------------	-------------------	--------------------------	------------	-----	-------------------

Vlakke plaat						
V	NX1090V	14	98119203	5	0,30	20 st. MG
R4	NX1090R4	14	98119206	5	0,27	20 st. MG

Vlakke plaat						
V	NX1100V	14	98143203	5	0,42	20 st. MG
R4	NX1100R4	14	98143206	5	0,36	20 st. MG

Vlakke plaat						
V	NX1110V	14	98145203	5	0,42	15 st. MG
R4	NX1110R4	14	98145206	5	0,36	15 st. MG

Vlakke plaat						
V	NX1120V	14	98144203	5	0,44	25 st. MG
R4	NX1120R4	14	98144206	5	0,36	25 st. MG

Vlakke plaat						
V	NX1130V	14	98141203	5	0,39	20 st. MG
R4	NX1130R4	14	98141206	5	0,37	20 st. MG

Vlakke plaat						
V	NX1140V	14	98139203	5	0,28	25 st. MG
R4	NX1140R4	14	98139206	5	0,26	25 st. MG

NX2 - Montagehoeken

Typenummer	Gatmaat ø mm	Artikel nummer	Materiaal dikte mm	kg stuk	VPE	Kortings groep
------------	-----------------	-------------------	--------------------------	------------	-----	-------------------

Montagehoek						
V	NX2000V	14	98111203	5	0,15	50 st. MG
R4	NX2000R4	14	98111206	5	0,13	50 st. MG

Montagehoek						
V	NX2010V	14	98110203	5	0,15	50 st. MG
R4	NX2010R4	14	98110206	5	0,13	50 st. MG

Montagehoek						
V	NX2020V	14	98112203	5	0,22	25 st. MG
R4	NX2020R4	14	98112206	5	0,20	25 st. MG

Montagehoek						
V	NX2030V	14	98114203	5	0,22	25 st. MG
R4	NX2030R4	14	98114206	5	0,20	25 st. MG

Montagehoek						
V	NX2040V	14	98118203	5	0,22	25 st. MG
R4	NX2040R4	14	98118206	5	0,20	25 st. MG

Montagehoek						
V	NX2045V	14	98126203	5	0,28	25 st. MG
R4	NX2045R4	14	98126206	5	0,26	25 st. MG

Montagehoek						
V	NX2050V	14	98116203	5	0,31	25 st. MG
R4	NX2050R4	14	98116206	5	0,27	25 st. MG

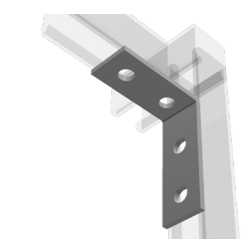
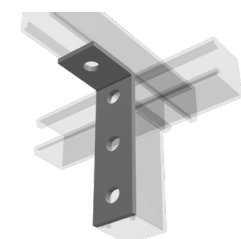
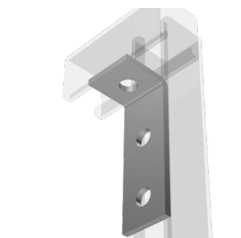
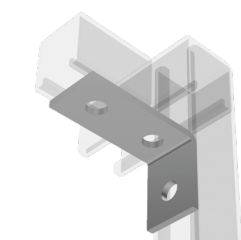
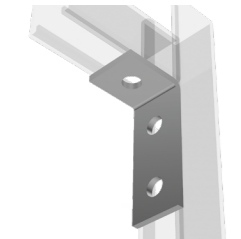
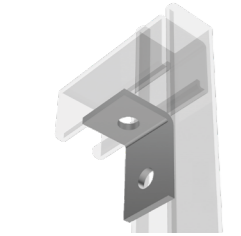
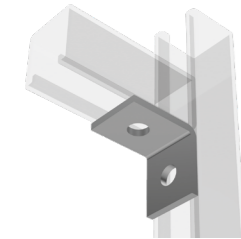

NX2 - Montagehoeken

Typenummer	Gatmaat ø mm	Artikel nummer	Materiaal dikte mm	kg stuk	VPE	Kortings groep
------------	-----------------	-------------------	--------------------------	------------	-----	-------------------

Montagehoek						
V	NX2060V	14	98117203	5	0,46	10 st. MG
R4	NX2060R4	14	98117206	5	0,44	10 st. MG

Montagehoek						
V	NX2070V	14	98130203	5	0,32	25 st. MG
R4	NX2070R4	14	98130206	5	0,30	25 st. MG

Montagehoek						
V	NX2080V	14	98113203	5	0,45	20 st. MG
R4	NX2080R4	14	98113206	5	0,36	20 st. MG

Montagehoek						
V	NX2090V	14	98127203	5	0,29	20 st. MG
R4	NX2090R4	14	98127206	5	0,27	20 st. MG

Montagehoek						
V	NX2095V	14	98104203	5	0,51	20 st. MG
R4	NX2095R4	14	98104206	5	0,44	20 st. MG

Montagehoek						
V	NX2100V	14	98128203	5	0,30	25 st. MG
R4	NX2100R4	14	98128206	5	0,27	25 st. MG

Montagehoek						
V	NX2110V	14	98129203	5	0,30	25 st. MG
R4	NX2110R4	14	98129206	5	0,27	25 st. MG

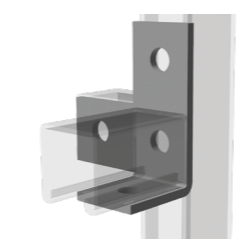
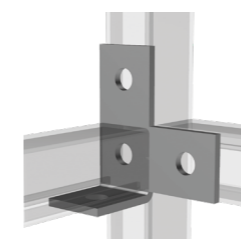
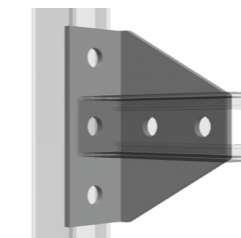
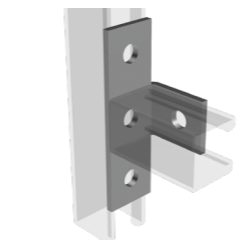
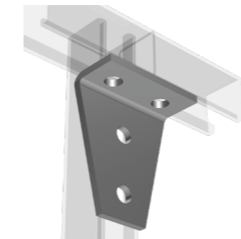
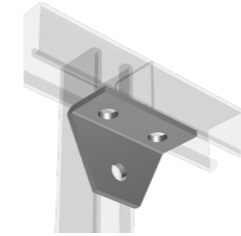
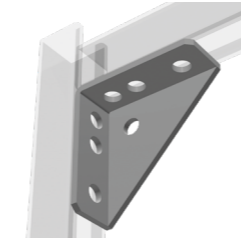

NX2 - Montagehoeken

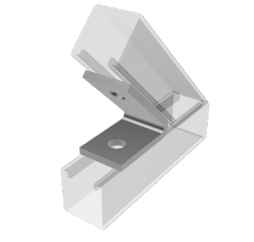
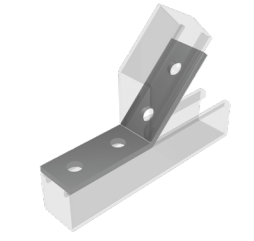
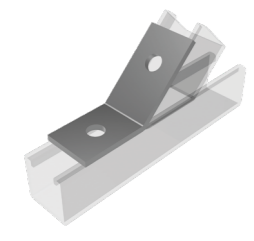
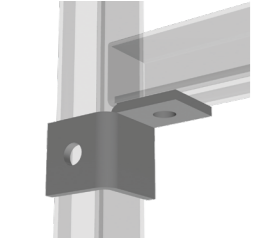
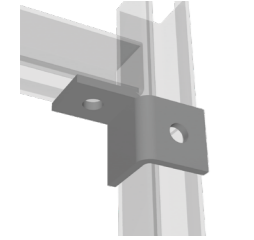
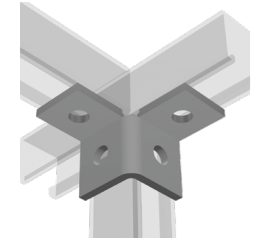

Typenummer	Gatmaat ø mm	Artikel nummer	Materiaal dikte mm	kg stuk	VPE	Kortings groep
------------	-----------------	-------------------	--------------------------	------------	-----	-------------------

Montagehoek

V	NX2120V	14	98094203	5	0,29	25 st.	MG
R4	NX2120R4	14	98094206	5	0,26	25 st.	MG

Montagehoek

V	NX2130V	14	98095203	5	0,22	25 st.	MG
R4	NX2130R4	14	98095206	5	0,20	25 st.	MG

Montagehoek

V	NX2140V	14	98096203	5	0,22	25 st.	MG
R4	NX2140R4	14	98096206	5	0,20	25 st.	MG

Montagehoek 135°

V	NX2150V	14	98109203	5	0,25	25 st.	MG
R4	NX2150R4	14	98109206	5	0,20	25 st.	MG

Montagehoek 135°

V	NX2155V	14	98108203	5	0,31	25 st.	MG
R4	NX2155R4	14	98108206	5	0,28	25 st.	MG

Montagehoek 45°

V	NX2160V	14	98142203	5	0,25	25 st.	MG
R4	NX2160R4	14	98142206	5	0,20	25 st.	MG

Montagehoek, instelbaar ≥ 50°

V	NX2170V	14	98106203	5	0,38	20 st.	MG
----------	---------	----	-----------------	---	------	--------	----

NX3 - U en Z beugels

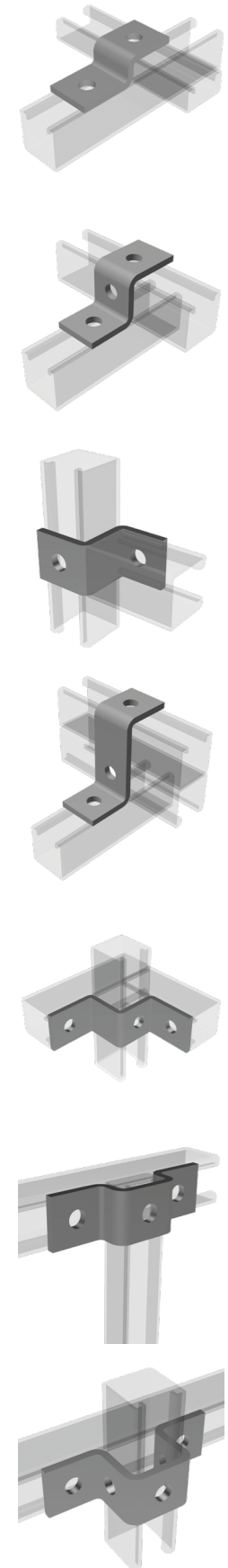

Typenummer	Geschikt voor profiel B x H in mm	Artikel nummer	Materiaal dikte mm	kg stuk	VPE	Kortings groep
------------	-----------------------------------	----------------	--------------------	---------	-----	----------------

Z - beugel*

V	NX3000V	41 x 21	98131203	5	0,19	25 st.	MG
R4	NX3000R4	41 x 21	98131206	5	0,17	25 st.	MG

Z - beugel*

V	NX3010V	41 x 41	98132203	5	0,23	25 st.	MG
R4	NX3010R4	41 x 41	98132206	5	0,18	25 st.	MG

Z - beugel*

V	NX3015V	41 x 41	98100203	5	0,23	25 st.	MG
R4	NX3015R4	41 x 41	98100206	5	0,22	25 st.	MG

Z - beugel*

V	NX3020V	41 x 82	98135203	5	0,28	25 st.	MG
R4	NX3020R4	41 x 82	98135206	5	0,23	25 st.	MG

Z - beugel*

V	NX3025V	41 x 41	98102203	5	0,31	25 st.	MG
R4	NX3025R4	41 x 41	98102206	5	0,28	25 st.	MG

U - beugel*

V	NX3030V	41 x 21	98133203	5	0,28	25 st.	MG
R4	NX3030R4	41 x 21	98133206	5	0,24	25 st.	MG

U - beugel*

V	NX3040V	41 x 41	98134203	5	0,36	20 st.	MG
R4	NX3040R4	41 x 41	98134206	5	0,29	20 st.	MG

* Gatmaat ø14 mm

NX3 - U en Z beugels

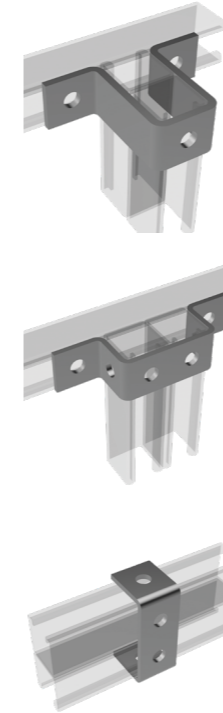

Typenummer	Geschikt voor profiel B x H in mm	Artikel nummer	Materiaal dikte mm	kg stuk	VPE	Kortings groep
------------	-----------------------------------	----------------	--------------------	---------	-----	----------------

U - beugel*

V	NX3050V	41 x 82	98136203	5	0,50	10 st.	MG
R4	NX3050R4	41 x 82	98136206	5	0,41	10 st.	MG

U - beugel*

V	NX3060V	41 x 82	98137203	5	0,46	10 st.	MG
R4	NX3060R4	41 x 82	98137206	5	0,34	10 st.	MG

U - beugel*

V	NX3070V	41 x 82	98138203	5	0,30	25 st.	MG
R4	NX3070R4	41 x 82	98138206	5	0,24	25 st.	MG

* Gatmaat ø14 mm

NX4 - Koppelstukken

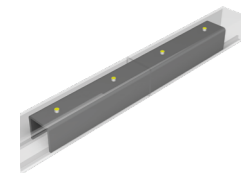
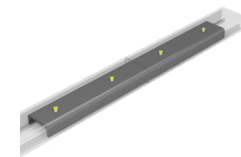
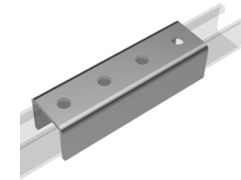
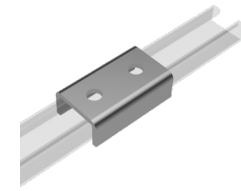

Typenummer	Geschikt voor profiel B x H in mm	Artikel nummer	Materiaal dikte mm	kg stuk	VPE	Kortings groep
------------	-----------------------------------	----------------	--------------------	---------	-----	----------------

Koppelstuk extern*, excl. bevestigingsmateriaal

V	NX4000V	41 x 21	98070203	5	0,60	25 st.	MG
R4	NX4000R4	41 x 21	98070206	5	0,58	25 st.	MG

Koppelstuk extern*, excl. bevestigingsmateriaal

V	NX4010V	41 x 41	98071203	5	0,94	10 st.	MG
R4	NX4010R4	41 x 41	98071206	5	0,87	10 st.	MG

Koppelstuk intern, incl. M6 bevestigingsmateriaal

V	NX4020V	41 x 21	98072203	2,5	0,14	25 st.	MG
----------	---------	---------	-----------------	-----	------	--------	----

Koppelstuk intern, incl. M6 bevestigingsmateriaal

V	NX4030V	41 x 41	98073203	2,5	0,24	20 st.	MG
----------	---------	---------	-----------------	-----	------	--------	----

* Gatmaat \varnothing 14 mm

NX5 - Voetplaten en vleugelstukken

Typenummer	Geschikt voor profiel B x H in mm	Artikel nummer	Materiaal dikte mm	kg stuk	VPE	Kortings groep
------------	-----------------------------------	----------------	--------------------	---------	-----	----------------

Voetplaat*

V	NX5000V	41 x 41	98120203	5	0,55	20 st.	MG
R4	NX5000R4	41 x 41	98120206	5	0,51	20 st.	MG

Voetplaat*

V	NX5010V	41 x 82	98121203	5	1,15	5 st.	MG
R4	NX5010R4	41 x 82	98121206	5	1,02	5 st.	MG

Vleugelstuk*

V	NX5020V	41 x 41	98122203	5	1,65	5 st.	MG
R4	NX5020R4	41 x 41	98122206	5	1,46	5 st.	MG

Vleugelstuk*

V	NX5030V	41 x 82	98123203	5	1,85	5 st.	MG
R4	NX5030R4	41 x 82	98123206	5	1,69	5 st.	MG

Voetplaat 45°*

V	NX5040V	41 x 41	98124203	5	1,70	5 st.	MG
R4	NX5040R4	41 x 41	98124206	5	1,54	5 st.	MG

Voetplaat 90°*

V	NX5045V	41 x 41	98098203	5	1,70	5 st.	MG
R4	NX5045R4	41 x 41	98098206	5	1,54	5 st.	MG

Voetplaat 45°*

V	NX5050V	41 x 82	98125203	5	1,80	5 st.	MG
R4	NX5050R4	41 x 82	98125206	5	1,61	5 st.	MG

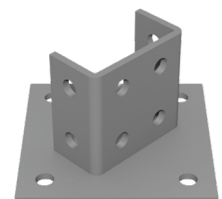
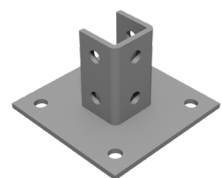
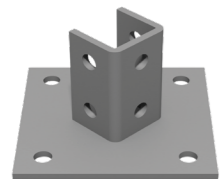
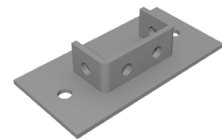
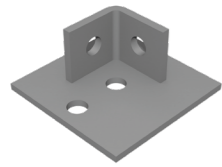

* Gatmaat ø14 mm

NX5 - Voetplaten en vleugelstukken

Typenummer	Geschikt voor profiel B x H in mm	Artikel nummer	Materiaal dikte mm	kg stuk	VPE	Kortings groep
------------	-----------------------------------	----------------	--------------------	---------	-----	----------------

Voetplaat 90°*

V	NX5055V	41 x 82	98099203	5	1,80	5 st.	MG
R4	NX5055R4	41 x 82	98099206	5	1,61	5 st.	MG

Vleugelstuk*

V	NX5060V	41 x 41	98115203	5	0,58	10 st.	MG
R4	NX5060R4	41 x 41	98115206	5	0,53	10 st.	MG

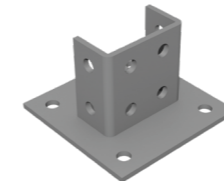

* Gatmaat ø14 mm

NX6 - Balkklemmen

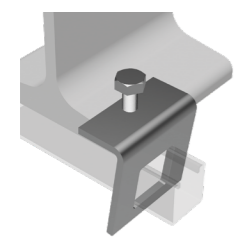
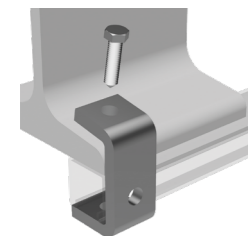
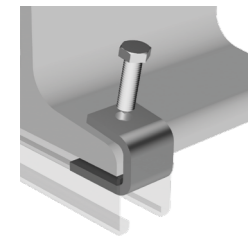
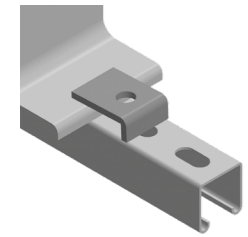
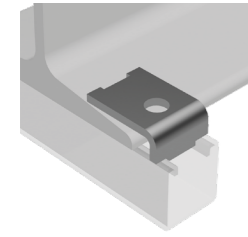
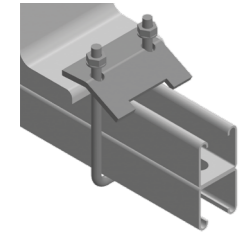
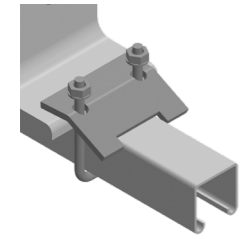

Typenummer	Geschikt voor profiel B x H in mm	Artikel nummer	Klem bereik ≤ mm	kg stuk	VPE	Kortings groep
------------	-----------------------------------	----------------	------------------	---------	-----	----------------

Balkklem, incl. M10 bevestigingsmateriaal

V	NX6000V	41 x 41, 41 x 21, 41 x 21D	98961203	18	0,29	10 st.	MG
R4	NX6000R4	41 x 41, 41 x 21, 41 x 21D	98961206	18	0,25	10 st.	MG

Balkklem, incl. M10 bevestigingsmateriaal

V	NX6010V	41 x 41D	98963203	18	0,33	10 st.	MG
R4	NX6010R4	41 x 41D	98963206	18	0,29	10 st.	MG

Balkklem A* met lip, excl. bevestigingsmateriaal

V	NX6020V		98548203	13	0,12	50 st.	MG
R4	NX6020R4		98548206	13	0,09	50 st.	MG

Balkklem C* zonder lip, excl. bevestigingsmateriaal

V	NX6030V		98550203	15	0,11	100 st.	MG
R4	NX6030R4		98550206	15	0,09	100 st.	MG

Balkklem U, incl. conepointbout

V	NX6040V		98146203	22	0,13	25 st.	MG
R4	NX6040R4		98146206	22	0,12	25 st.	MG

Balkklem*, incl. conepointbout

V	NX6050V	41x41,41x21D	98147203	22	0,38	10 st.	MG
R4	NX6050R4	41x41,41x21D	98147206	22	0,34	10 st.	MG

Balkklem W, incl. conepointbout

V	NX6060V	41x41,41x21D	98149203	22	0,43	20 st.	MG
R4	NX6060R4	41x41,41x21D	98149206	22	0,38	20 st.	MG

* Gatmaat ø14 mm

NX6 - Balkklemmen

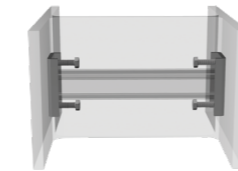
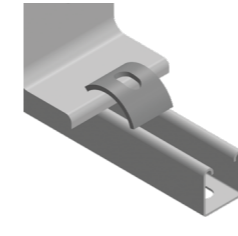
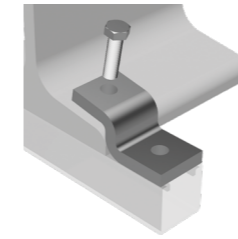

Typenummer	Geschikt voor profiel B x H in mm	Artikel nummer	Klem bereik ≤ mm	kg stuk	VPE	Kortings groep
------------	-----------------------------------	----------------	------------------	---------	-----	----------------

Balkklem Z*, incl. conepointbout

V	NX6070V		98148203	25	0,35	25 st.	MG
R4	NX6070R4		98148206	25	0,33	25 st.	MG

Balkklem B met sleuf 11 x 24 mm

V	NX6080V		98546203		0,11	100 st.	MG
R4	NX6080R4		98546206		0,09	200 st.	MG

Balkklemset, incl. conepointbouten

V	NX6090V	41 x 41	98150203	400	0,58	10 st.	MG
R4	NX6090R4	41 x 41	98150206	400	0,53	10 st.	MG

* Gatmaat ø14 mm

NX6 - Balkklemmen



Typenummer	Gatmaat	Artikel nummer	Klem bereik ≤ mm	kg stuk	VPE	Kortings groep
------------	---------	----------------	------------------	---------	-----	----------------

Balkklem P getapt

E	NX6100E	M6	98920201	18	0,086	50 st.	MG
	NX6110E	M8	98921201	18	0,083	50 st.	MG
	NX6120E	M10	98922201	20	0,146	50 st.	MG
	NX6130E	M12	98923201	26	0,222	50 st.	MG
	NX6140E	M16	98924201	28	0,353	50 st.	MG

Balkklem P met gat

E	NX6150E	ø7 mm	98926201	18	0,084	50 st.	MG
	NX6160E	ø9 mm	98927201	18	0,081	50 st.	MG
	NX6170E	ø11 mm	98928201	20	0,141	50 st.	MG
	NX6180E	ø13 mm	98929201	26	0,218	50 st.	MG
	NX6190E	ø17 mm	98930201	28	0,339	50 st.	MG

Balkklem P getapt

V	NX6100V	M6	98920203	18	0,086	50 st.	MG
---	---------	----	-----------------	----	-------	--------	----

Balkklem P met gat

V	NX6150V	ø7 mm	98926203	18	0,084	50 st.	MG
	NX6160V	ø9 mm	98927203	18	0,081	50 st.	MG
	NX6170V	ø11 mm	98928203	20	0,141	50 st.	MG
	NX6180V	ø13 mm	98929203	26	0,218	50 st.	MG

Balkklem P met gat

R4	NX6160R4	ø9 mm	98927206	16,5	0,170	50 st.	MG
	NX6170R4	ø11 mm	98928206	16,5	0,165	50 st.	MG
	NX6180R4	ø13 mm	98929206	16,5	0,159	50 st.	MG

NX7 - Glijmoeren en hamerkopbouten

Typenummer	Draadmaat	Artikel nummer	Materiaal dikte mm	kg stuk	VPE	Kortings groep
------------	-----------	----------------	--------------------	---------	-----	----------------

Glijmoer zonder veer							
E	NX7000E	M6	98086201	6	0,028	100 st.	MG
	NX7010E	M8	98088201	6	0,026	100 st.	MG
	NX7020E	M10	98090201	8	0,035	100 st.	MG
	NX7030E	M12	98092201	9	0,040	100 st.	MG
	NX7040E	M16	98093201	10	0,045	50 st.	MG
V	NX7000V	M6	98086203	6	0,030	100 st.	MG
	NX7010V	M8	98088203	6	0,029	100 st.	MG
	NX7020V	M10	98090203	8	0,036	100 st.	MG
	NX7030V	M12	98092203	9	0,041	100 st.	MG
R4	NX7040V	M16	98093203	10	0,048	50 st.	MG
	NX7000R4	M6	98086206	6	0,028	100 st.	MG
	NX7010R4	M8	98088206	6	0,026	100 st.	MG
	NX7020R4	M10	98090206	8	0,035	100 st.	MG
	NX7030R4	M12	98092206	9	0,040	100 st.	MG
NX7040R4	M16	98093206	10	0,045	50 st.	MG	

Glijmoer met korte veer							
E	NX7050E	M6	98086211	6	0,029	100 st.	MG
	NX7060E	M8	98088211	6	0,027	100 st.	MG
	NX7070E	M10	98090211	8	0,035	100 st.	MG
	NX7080E	M12	98092211	9	0,041	100 st.	MG
V	NX7050V	M6	98086213	6	0,031	100 st.	MG
	NX7060V	M8	98088213	6	0,029	100 st.	MG
	NX7070V	M10	98090213	8	0,037	100 st.	MG
	NX7080V	M12	98092213	9	0,043	100 st.	MG
R4	NX7050R4	M6	98086216	6	0,029	100 st.	MG
	NX7060R4	M8	98088216	6	0,027	100 st.	MG
	NX7070R4	M10	98090216	8	0,035	100 st.	MG
	NX7080R4	M12	98092216	9	0,041	100 st.	MG

Glijmoer met lange veer							
E	NX7090E	M6	98086221	6	0,030	100 st.	MG
	NX7100E	M8	98088221	6	0,028	100 st.	MG
	NX7110E	M10	98090221	8	0,036	100 st.	MG
	NX7120E	M12	98092221	9	0,042	100 st.	MG
V	NX7090V	M6	98086223	6	0,032	100 st.	MG
	NX7100V	M8	98088223	6	0,030	100 st.	MG
	NX7110V	M10	98090223	8	0,038	100 st.	MG
	NX7120V	M12	98092223	9	0,044	100 st.	MG
R4	NX7090R4	M6	98086226	6	0,030	100 st.	MG
	NX7100R4	M8	98088226	6	0,028	100 st.	MG
	NX7110R4	M10	98090226	8	0,036	100 st.	MG
	NX7120R4	M12	98092226	9	0,042	100 st.	MG



NX7 - Glijmoeren en hamerkopbouten

Typenummer	Draadmaat	Artikel nummer	Materiaal dikte glijmoer mm	kg stuk	VPE	Kortings groep
------------	-----------	----------------	-----------------------------	---------	-----	----------------

Glijmoer met klemplaat							
E	NX7130E	M6	98880201	6	0,078	100 st.	MG
	NX7140E	M8	98881201	6	0,078	100 st.	MG
	NX7150E	M10	98882201	8	0,078	100 st.	MG
	NX7160E	M12	98883201	9	0,078	100 st.	MG

Glijmoer met fixatie							
E	NX7170E	M6	98885201	6	0,029	100 st.	MG
	NX7180E	M8	98886201	6	0,028	100 st.	MG
	NX7190E	M10	98887201	8	0,034	100 st.	MG
	NX7200E	M12	98888201	9	0,041	100 st.	MG
V	NX7170V	M6	98885203	6	0,030	100 st.	MG
	NX7180V	M8	98886203	6	0,030	100 st.	MG
	NX7190V	M10	98887203	8	0,037	100 st.	MG
	NX7200V	M12	98888203	9	0,041	100 st.	MG
R4	NX7170R4	M6	98885206	6	0,029	100 st.	MG
	NX7180R4	M8	98886206	6	0,028	100 st.	MG
	NX7190R4	M10	98887206	8	0,034	100 st.	MG
	NX7200R4	M12	98888206	9	0,041	100 st.	MG

Hamerkopbout, incl. carrosseriering en moer							
E	NX7210E	M8x30	98890201	6	0,074	50 st.	MG
	NX7220E	M8x40	98892201	6	0,080	50 st.	MG
	NX7230E	M8x60	98894201	6	0,084	50 st.	MG
	NX7240E	M10x30	98896201	8	0,086	50 st.	MG
	NX7250E	M10x40	98898201	8	0,097	50 st.	MG
	NX7260E	M10x60	98900201	8	0,105	50 st.	MG
	NX7270E	M10x80	98902201	8	0,125	50 st.	MG
	NX7280E	M10x100	98904201	8	0,132	25 st.	MG
	NX7290E	M12x30	98906201	9	0,107	50 st.	MG
	NX7300E	M12x40	98908201	9	0,113	50 st.	MG
R4	NX7310E	M12x60	98910201	9	0,130	50 st.	MG
	NX7220R4	M8x40	98892206	6	0,073	50 st.	MG
	NX7250R4	M10x40	98898206	8	0,097	50 st.	MG

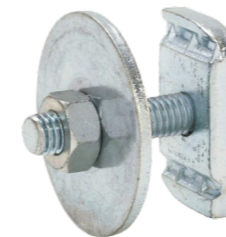
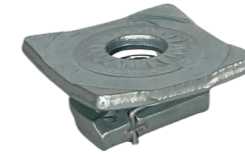

NX8 - Eindkappen en deksels

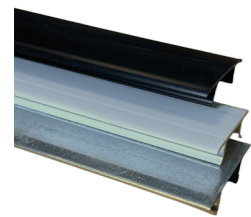
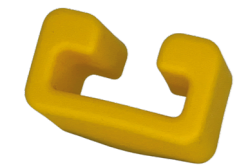

Typenummer	Geschikt voor profiel B x H in mm	Artikel nummer	Kleur	kg stuk	VPE	Kortings groep
------------	-----------------------------------	----------------	-------	---------	-----	----------------

Eindkap, inwendig

K	NX8000K	41 x 21	99961207	Zwart	0,005	100 st.	MG
	NX8010K	41 x 21	99962207	Wit	0,005	100 st.	MG
	NX8015K	41 x 21	99965207	Blauw	0,005	100 st.	MG

Eindkap, inwendig

K	NX8020K	41 x 41	99963207	Zwart	0,01	100 st.	MG
	NX8030K	41 x 41	99964207	Wit	0,01	100 st.	MG
	NX8035K	41 x 41	99966207	Blauw	0,01	100 st.	MG

Eindkap, uitwendig

K	NX8040K	41 x 21	99973207	Geel	0,01	20 st.	MG
---	---------	---------	----------	------	------	--------	----

Eindkap, uitwendig

K	NX8050K	41 x 41	99974207	Geel	0,01	20 st.	MG
---	---------	---------	----------	------	------	--------	----

Deksel railprofiel

K	NX8060K		99958207	Zwart	0,48	3 m	MG
	NX8070K		99959207	Wit	0,48	3 m	MG
S	NX8080S		99960202		1,07	3 m	MG

NX9 - Consoles

Typenummer	Profiel lengte mm	Artikel nummer	Materiaal dikte profiel mm	kg stuk	VPE	Kortings groep
------------	-------------------	----------------	----------------------------	---------	-----	----------------

Console Strut EP 41 x 41*						
V	NX9000V	100	98380203	2,5	0,70	1 st. MG
	NX9010V	150	98381203	2,5	0,83	1 st. MG
	NX9020V	200	98382203	2,5	0,95	1 st. MG
	NX9030V	250	98383203	2,5	1,08	1 st. MG
	NX9040V	300	98384203	2,5	1,21	1 st. MG
	NX9050V	350	98385203	2,5	1,34	1 st. MG
	NX9060V	400	98386203	2,5	1,47	1 st. MG
	NX9070V	450	98387203	2,5	1,59	1 st. MG
	NX9080V	500	98388203	2,5	1,72	1 st. MG
	NX9090V	550	98389203	2,5	1,85	1 st. MG
	NX9100V	600	98390203	2,5	1,98	1 st. MG
	NX9110V	650	98391203	2,5	2,11	1 st. MG
	NX9120V	700	98392203	2,5	2,25	1 st. MG
	NX9130V	750	98393203	2,5	2,38	1 st. MG
	NX9140V	1000	98394203	2,5	2,99	1 st. MG
NX9150V	1500	98395203	2,5	4,25	1 st. MG	
R4	NX9000R4	100	98380206	2,5	0,64	1 st. MG
	NX9010R4	150	98381206	2,5	0,78	1 st. MG
	NX9020R4	200	98382206	2,5	0,87	1 st. MG
	NX9030R4	250	98383206	2,5	0,98	1 st. MG
	NX9040R4	300	98384206	2,5	1,10	1 st. MG
	NX9050R4	350	98385206	2,5	1,23	1 st. MG
	NX9060R4	400	98386206	2,5	1,35	1 st. MG
	NX9070R4	450	98387206	2,5	1,47	1 st. MG
	NX9080R4	500	98388206	2,5	1,58	1 st. MG
	NX9090R4	550	98389206	2,5	1,71	1 st. MG
	NX9100R4	600	98390206	2,5	1,83	1 st. MG
	NX9110R4	650	98391206	2,5	1,95	1 st. MG
	NX9120R4	700	98392206	2,5	2,08	1 st. MG
	NX9130R4	750	98393206	2,5	2,20	1 st. MG
	NX9140R4	1000	98394206	2,5	2,81	1 st. MG
NX9150R4	1500	98395206	2,5	3,87	1 st. MG	

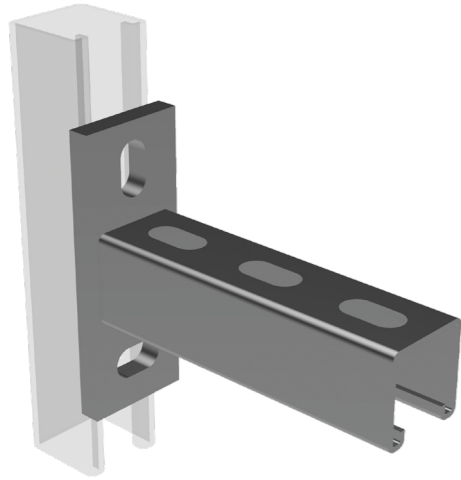

NX9 - Consoles

Typenummer	Profiel lengte mm	Artikel nummer	Materiaal dikte profiel mm	kg stuk	VPE	Kortings groep
------------	-------------------	----------------	----------------------------	---------	-----	----------------

Console Strut DP 2x 41 x 41*							
V	NX9200V	300	98290203	2,5	2,21	1 st. MG	
	NX9210V	350	98291203	2,5	2,46	1 st. MG	
	NX9220V	400	98292203	2,5	2,79	1 st. MG	
	NX9230V	450	98293203	2,5	3,09	1 st. MG	
	NX9240V	500	98294203	2,5	3,33	1 st. MG	
	NX9250V	550	98295203	2,5	3,56	1 st. MG	
	NX9260V	600	98296203	2,5	3,79	1 st. MG	
	NX9270V	650	98297203	2,5	4,07	1 st. MG	
	NX9280V	700	98298203	2,5	4,36	1 st. MG	
	NX9290V	750	98299203	2,5	4,73	1 st. MG	
	NX9300V	1000	98300203	2,5	5,64	1 st. MG	
	NX9310V	1500	98301203	2,5	8,09	1 st. MG	
	R4	NX9200R4	300	98290206	2,5	2,07	1 st. MG
		NX9210R4	350	98291206	2,5	2,32	1 st. MG
		NX9220R4	400	98292206	2,5	2,58	1 st. MG
NX9230R4		450	98293206	2,5	2,83	1 st. MG	
NX9240R4		500	98294206	2,5	3,09	1 st. MG	
NX9250R4		550	98295206	2,5	3,34	1 st. MG	
NX9260R4		600	98296206	2,5	3,59	1 st. MG	
NX9270R4		650	98297206	2,5	3,85	1 st. MG	
NX9280R4		700	98298206	2,5	4,11	1 st. MG	
NX9290R4		750	98299206	2,5	4,36	1 st. MG	
NX9300R4		1000	98300206	2,5	5,24	1 st. MG	
NX9310R4		1500	98301206	2,5	7,71	1 st. MG	

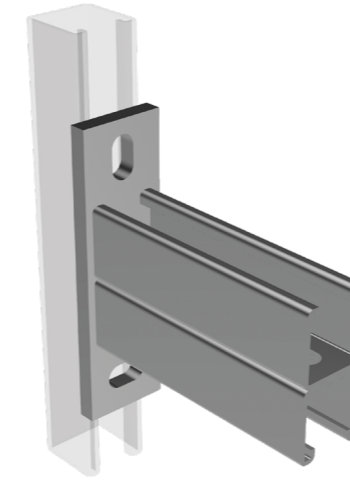

* Sleufgat achterplaat 13 x 25 mm

* Sleufgat achterplaat 13 x 25 mm

Bevestigingsmateriaal

Typenummer	Draadmaat	Artikel nummer	 stuk	 VPE	Kortings groep
------------	-----------	----------------	--	---	----------------

Tapbout - DIN 933

E	Tapbout	M6x20	99776201	0,0058	100 st.	MG
	Tapbout	M6x25	99777201	0,0067	100 st.	MG
	Tapbout	M6x35	99778201	0,0084	100 st.	MG
	Tapbout	M6x40	99779201	0,0092	100 st.	MG
	Tapbout	M8x20	99781201	0,0123	100 st.	MG
	Tapbout	M8x25	99782201	0,0139	100 st.	MG
	Tapbout	M8x30	99783201	0,0150	100 st.	MG
	Tapbout	M8x40	99785201	0,0203	100 st.	MG
	Tapbout	M10x20	99791201	0,0212	100 st.	MG
	Tapbout	M10x25	99792201	0,0237	100 st.	MG
	Tapbout	M10x30	99793201	0,0262	100 st.	MG
	Tapbout	M10x40	99794201	0,0312	100 st.	MG
	Tapbout	M10x50	99795201	0,0362	100 st.	MG
	Tapbout	M10x60	99796201	0,0413	100 st.	MG
	Tapbout	M10x70	99797201	0,0456	100 st.	MG
	Tapbout	M12x20	99800201	0,0333	100 st.	MG
	Tapbout	M12x25	99801201	0,0341	100 st.	MG
	Tapbout	M12x30	99802201	0,0377	100 st.	MG
	Tapbout	M12x40	99803201	0,0449	100 st.	MG
	V	Tapbout	M6x20 ISO	99776203	0,0060	100 st.
Tapbout		M6x25 ISO	99777203	0,0068	100 st.	MG
Tapbout		M6x35 ISO	99778203	0,0086	100 st.	MG
Tapbout		M6x40 ISO	99779203	0,0095	100 st.	MG
Tapbout		M8x20 ISO	99781203	0,0127	100 st.	MG
Tapbout		M8x25 ISO	99782203	0,0144	100 st.	MG
Tapbout		M8x30 ISO	99783203	0,0153	100 st.	MG
Tapbout		M8x40 ISO	99785203	0,0205	100 st.	MG
Tapbout		M10x20 ISO	99791203	0,0214	100 st.	MG
Tapbout		M10x25 ISO	99792203	0,0238	100 st.	MG
Tapbout		M10x30 ISO	99793203	0,0265	100 st.	MG
Tapbout		M10x40 ISO	99794203	0,0316	100 st.	MG
Tapbout		M10x50 ISO	99795203	0,0367	100 st.	MG
Tapbout		M10x60 ISO	99796203	0,0415	100 st.	MG
Tapbout		M10x70 ISO	99797203	0,0458	100 st.	MG
Tapbout		M12x20 ISO	99800203	0,0335	100 st.	MG
Tapbout	M12x25 ISO	99801203	0,0344	100 st.	MG	
Tapbout	M12x30 ISO	99802203	0,0380	100 st.	MG	
Tapbout	M12x40 ISO	99803203	0,0452	100 st.	MG	
R4	Tapbout	M6x20	99776206	0,0058	100 st.	MG
	Tapbout	M6x25	99777206	0,0067	100 st.	MG
	Tapbout	M6x35	99778206	0,0084	100 st.	MG
	Tapbout	M6x40	99779206	0,0092	100 st.	MG
	Tapbout	M8x20	99781206	0,0123	100 st.	MG
	Tapbout	M8x25	99782206	0,0139	100 st.	MG
	Tapbout	M8x30	99783206	0,0150	100 st.	MG
	Tapbout	M8x40	99785206	0,0203	100 st.	MG
	Tapbout	M10x20	99791206	0,0212	100 st.	MG
	Tapbout	M10x25	99792206	0,0237	100 st.	MG
	Tapbout	M10x30	99793206	0,0262	100 st.	MG
	Tapbout	M10x40	99794206	0,0312	100 st.	MG
	Tapbout	M10x50	99795206	0,0362	100 st.	MG
	Tapbout	M10x60	99796206	0,0413	100 st.	MG
	Tapbout	M10x70	99797206	0,0456	100 st.	MG
	Tapbout	M12x20	99800206	0,0333	100 st.	MG
Tapbout	M12x25	99801206	0,0341	100 st.	MG	
Tapbout	M12x30	99802206	0,0377	100 st.	MG	
Tapbout	M12x40	99803206	0,0449	100 st.	MG	



Bevestigingsmateriaal

Typenummer	Draadmaat	Artikel nummer	 stuk	 VPE	Kortings groep
------------	-----------	----------------	--	---	----------------

Conepointbout

V	Conepointbout	M10x40 ISO	99733203	0,0312	100 st.	MG
R4	Conepointbout	M10x40	99733206	0,0310	100 st.	MG



Moer - DIN 934

E	Moer	M6	99816201	0,003	100 st.	MG
	Moer	M8	99817201	0,005	100 st.	MG
	Moer	M10	99818201	0,010	100 st.	MG
	Moer	M12	99819201	0,017	100 st.	MG
V	Moer	M6 ISO	99816203	0,004	100 st.	MG
	Moer	M8 ISO	99817203	0,005	100 st.	MG
	Moer	M10 ISO	99818203	0,012	100 st.	MG
	Moer	M12 ISO	99819203	0,018	100 st.	MG
R4	Moer	M6	99816206	0,003	100 st.	MG
	Moer	M8	99817206	0,005	100 st.	MG
	Moer	M10	99817206	0,010	100 st.	MG
	Moer	M12	99819206	0,017	100 st.	MG

Flensmoer - DIN 6923

E	Flensmoer	M6	99812201	0,003	100 st.	MG
	Flensmoer	M8	99813201	0,007	100 st.	MG
	Flensmoer	M10	99814201	0,014	100 st.	MG
	Flensmoer	M12	99815201	0,023	100 st.	MG
V	Flensmoer	M6 ISO	99812203	0,004	100 st.	MG
	Flensmoer	M8 ISO	99813203	0,009	100 st.	MG
	Flensmoer	M10 ISO	99814203	0,016	100 st.	MG
	Flensmoer	M12 ISO	99815203	0,026	100 st.	MG
R4	Flensmoer	M6	99812206	0,003	100 st.	MG
	Flensmoer	M8	99813206	0,007	100 st.	MG
	Flensmoer	M10	99814206	0,014	100 st.	MG
	Flensmoer	M12	99815206	0,023	100 st.	MG

Bevestigingsmateriaal

Typenummer	Voor draadmaat	Artikel nummer	Lengte mm	kg stuk	VPE	Kortings groep
------------	----------------	----------------	-----------	---------	-----	----------------

Sluitring - DIN 125A / DIN 126

E	Sluitring	M6	99841201		0,0010	100 st.	MG
	Sluitring	M8	99842201		0,0018	100 st.	MG
	Sluitring	M10	99843201		0,0036	100 st.	MG
	Sluitring	M12	99844201		0,0063	100 st.	MG
V	Sluitring	M6	99841203		0,0010	100 st.	MG
	Sluitring	M8	99842203		0,0019	100 st.	MG
	Sluitring	M10	99843203		0,0038	100 st.	MG
R4	Sluitring	M12	99844203		0,0066	100 st.	MG
	Sluitring	M6	99841206		0,0010	100 st.	MG
	Sluitring	M8	99842206		0,0018	100 st.	MG
	Sluitring	M10	99843206		0,0036	100 st.	MG
	Sluitring	M12	99844206		0,0063	100 st.	MG

Carrosseriering - DIN 9021

E	Carrosseriering	M6	99849201		0,0030	100 st.	MG
	Carrosseriering	M8	99850201		0,0070	100 st.	MG
	Carrosseriering	M10	99851201		0,0120	100 st.	MG
	Carrosseriering	M12	99852201		0,0220	100 st.	MG
V	Carrosseriering	M6	99849203		0,0033	100 st.	MG
	Carrosseriering	M8	99850203		0,0075	100 st.	MG
	Carrosseriering	M10	99851203		0,0124	100 st.	MG
	Carrosseriering	M12	99852203		0,0225	100 st.	MG
R4	Carrosseriering	M6	99849206		0,0030	100 st.	MG
	Carrosseriering	M8	99850206		0,0070	100 st.	MG
	Carrosseriering	M10	99851206		0,0120	100 st.	MG
	Carrosseriering	M12	99852206		0,0220	100 st.	MG

Veerring - DIN 127B

E	Veerring	M6	99741201		0,0010	100 st.	MG
	Veerring	M8	99742201		0,0020	100 st.	MG
	Veerring	M10	99743201		0,0030	100 st.	MG
	Veerring	M12	99744201		0,0040	100 st.	MG
V	Veerring	M6	99741203		0,0013	100 st.	MG
	Veerring	M8	99742203		0,0023	100 st.	MG
	Veerring	M10	99743203		0,0033	100 st.	MG
	Veerring	M12	99744203		0,0043	100 st.	MG
R4	Veerring	M6	99741206		0,0010	100 st.	MG
	Veerring	M8	99742206		0,0020	100 st.	MG
	Veerring	M10	99743206		0,0030	100 st.	MG
	Veerring	M12	99744206		0,0040	100 st.	MG

Verbindingsmoer - DIN 6334

E	Verbindingsmoer	M6	99828201	18	0,008	100 st.	MG
	Verbindingsmoer	M8	99829201	24	0,017	100 st.	MG
	Verbindingsmoer	M10	99830201	30	0,030	100 st.	MG
	Verbindingsmoer	M12	99831201	36	0,057	100 st.	MG
V	Verbindingsmoer	M10 ISO	99830203	30	0,033	100 st.	MG
	Verbindingsmoer	M12 ISO	99831203	36	0,061	100 st.	MG
R4	Verbindingsmoer	M6	99828206	18	0,008	100 st.	MG
	Verbindingsmoer	M8	99829206	24	0,017	100 st.	MG
	Verbindingsmoer	M10	99830206	30	0,030	100 st.	MG
	Verbindingsmoer	M12	99831206	36	0,057	100 st.	MG



Bevestigingsmateriaal

Typenummer	Draadmaat	Artikel nummer	Lengte mm	kg stuk	VPE	Kortings groep
------------	-----------	----------------	-----------	---------	-----	----------------

Draadstang - DIN 975

E	Draadstang	M6	99861201	1000	0,18	1 st.	MG	
	Draadstang	M6	99862201	3000	0,54	1 st.	MG	
	Draadstang	M8	99863201	1000	0,34	1 st.	MG	
	Draadstang	M8	99870201	2000	0,68	1 st.	MG	
	Draadstang	M8	99864201	3000	1,02	1 st.	MG	
	Draadstang	M10	99865201	1000	0,50	1 st.	MG	
	Draadstang	M10	99866201	2000	1,00	1 st.	MG	
	Draadstang	M10	99867201	3000	1,50	1 st.	MG	
	Draadstang	M12	99868201	1000	0,73	1 st.	MG	
	Draadstang	M12	99869201	3000	2,19	1 st.	MG	
	V	Draadstang	M8 ISO	99863203	1000	0,35	1 st.	MG
		Draadstang	M10 ISO	99865203	1000	0,52	1 st.	MG
Draadstang		M10 ISO	99867203	3000	1,56	1 st.	MG	
Draadstang		M12 ISO	99868203	1000	0,75	1 st.	MG	
R4	Draadstang	M12 ISO	99869203	3000	2,25	1 st.	MG	
	Draadstang	M6	99861206	1000	0,18	1 st.	MG	
	Draadstang	M6	99862206	3000	0,54	1 st.	MG	
	Draadstang	M8	99863206	1000	0,34	1 st.	MG	
	Draadstang	M8	99864206	3000	1,02	1 st.	MG	
	Draadstang	M10	99865206	1000	0,50	1 st.	MG	
	Draadstang	M10	99867206	3000	1,50	1 st.	MG	
	Draadstang	M12	99868206	1000	0,73	1 st.	MG	
Draadstang	M12	99869206	3000	2,19	1 st.	MG		

Zinkspray

Zinkspray	400 ml	99992207	Mat	0,54	1 st.	MG
Zinkspray	400 ml	99993207	Glans	0,54	1 st.	MG

Zinkverf

Zinkverf	250 ml	99996207		0,60	1 st.	MG
Zinkverf	500 ml	99997207		1,15	1 st.	MG

Dopsleutel

E	Dopsleutel	M10/B-21	98061207	Sleutel 17	0,074	1 st.	MG
	Dopsleutel	M10/B-41	98063207	Sleutel 17	0,160	1 st.	MG



by



Gouda Holland B.V.
Grote Esch 80
2841 MJ Moordrecht
Tel.: +31 (0) 182 506 200

info@goudaholland.nl
www.goudaholland.nl