

# Kabelkanalen Cable ducts

Tray H28(R)/H53(R)  
Tray H78R/H103R



**kabelbaan**

roestvaststaal

*cable duct*

*stainless steel*

Tray



Det Norske Veritas (DNV) en Germanischer Lloyd (GL)



# Tray H28/H28R

# Tray H53/H53R

Kabelbaan, Roestvaststaal

# Tray H78R

# Tray H103R

Cable duct, Stainless steel

Tray

- chemisch resistent
- kwaliteit AISI 304 (BS 304 S 15 / WL Norm 1.4301)
- kwaliteit AISI 316 (BS 316 S 11 / WL Norm 1.4404)
- afsluitbaar d.m.v. deksels (alleen H53R)
- standaardlengte 3000 mm

Op verzoek:

- afwijkende breedte-, hoogtematen en dikte
- gesloten uitvoering

- *chemically resistant*
- *AISI 304 (BS 304 S 15 / WL Standard 1.4301) quality*
- *AISI 316 (BS 316 S 11 / WL Standard 1.4404) quality*
- *a wide range of covers available (only H53R)*
- *standard length 3000 mm*

On request:

- *deviant width, heights and thickness*
- *solid type*

## Tray H28/H28R

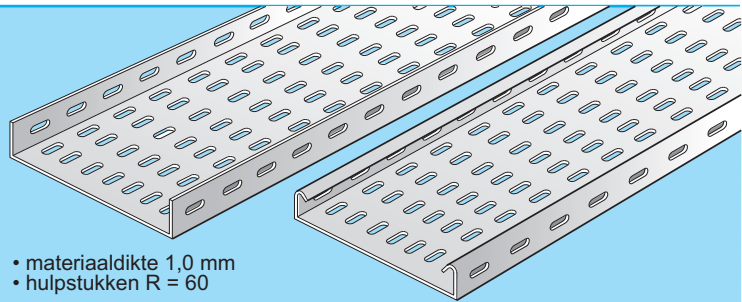
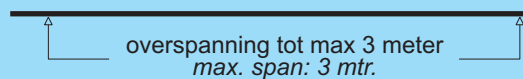
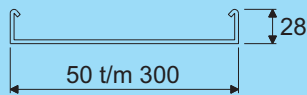

- materiaaldikte 1,0 mm
- hulpstukken R = 60
- *material thickness 1.0 mm*
- *fittings R = 60*

## Tray H53/H53R

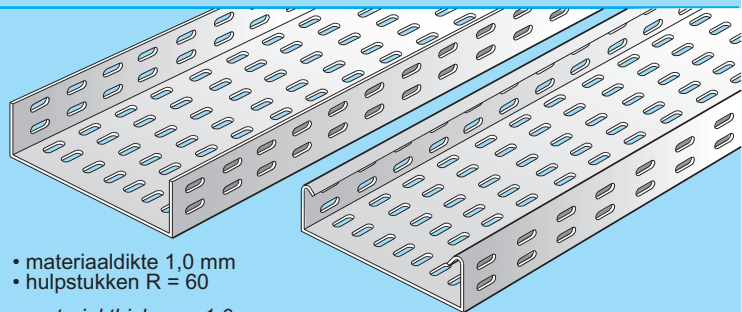
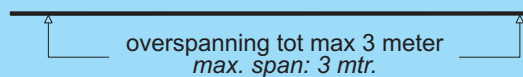
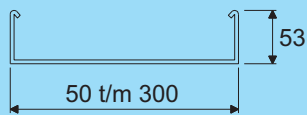

- materiaaldikte 1,0 mm
- hulpstukken R = 60
- *material thickness 1.0 mm*
- *fittings R = 60*

## Tray H78R

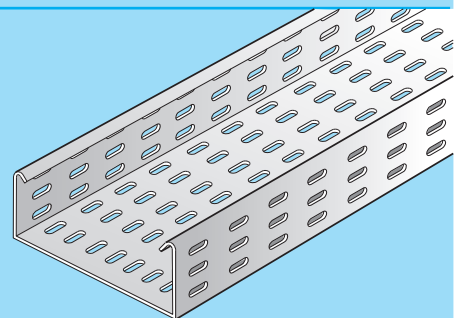
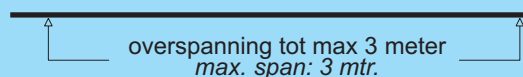
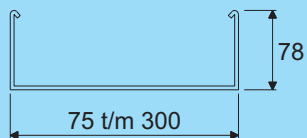

- materiaaldikte 1,0 mm
- hulpstukken R = 60
- *material thickness 1.0 mm*
- *fittings R = 60*

## Tray H103R

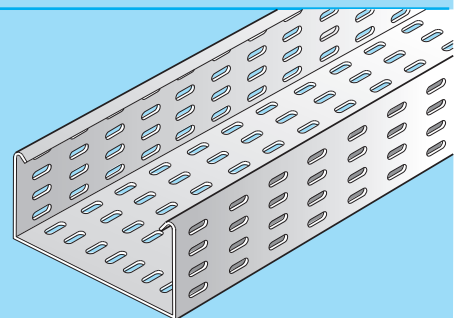
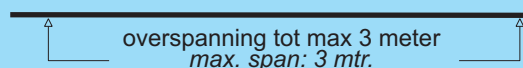
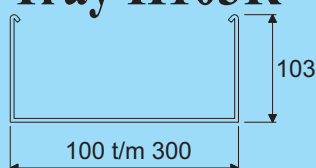

- materiaaldikte 1,0 mm
- hulpstukken R = 60
- *material thickness 1.0 mm*
- *fittings R = 60*

# Kabelkanalen Tray

# Cable ducts Tray

## Kabelbaan, Roestvaststaal

## Cable duct, Stainless steel

### B1-1 Algemeen

#### Pag.

- Inhoudsopgave B1-1-2
- Toepassingen B1-1-3
- Technische gegevens B1-1-4
- Belastbaarheidstabellen B1-1-5
- Systeemoverzicht B1-1-6

### B1-2 Tray H28/Tray H28R

- Kabelkanalen B1-2-1
- Koppelplaten/Scheidingsschot B1-2-2
- Eindschot/Hulpstukken/Deksels B1-2-3/10

### B1-3 Tray H53/Tray H53R

- Kabelkanalen B1-3-1
- Koppelplaten/Scheidingsschot B1-3-3
- Eindschot/Hulpstukken/Deksels B1-3-3/11

### B1-4 Tray H78R

- Kabelkanalen B1-4-1
- Koppelplaten/Scheidingsschot B1-4-3
- Eindschot/Hulpstukken/Deksels B1-4-3/11

### B1-5 Tray H103R

- Kabelkanalen B1-5-1
- Koppelplaten/Scheidingsschot B1-5-3
- Eindschot/Hulpstukken/Deksels B1-5-3/11

### B1-1 General

#### Page

- Table of contents B1-1-2
- Applications B1-1-3
- Technical specifications B1-1-4
- Loading labels B1-1-5
- Survey of the system B1-1-6

### B1-2 Tray H28/Tray H28R

- Cable ducts/Covers B1-2-1
- Splice plates/Separation strip B1-2-2
- Endplate/Fittings/Covers B1-2-3/10

### B1-3 Tray H53/Tray H53R

- Cable ducts/Covers B1-3-1
- Splice plates/Separation strip B1-3-3
- Endplate/Fittings/Covers B1-3-3/11

### B1-4 Tray H78R

- Cable ducts/Covers B1-4-1
- Splice plates/Separation strip B1-4-3
- Endplate/Fittings/Covers B1-4-3/11

### B1-5 Tray H103R

- Cable ducts/Covers B1-5-1
- Splice plates/Separation strip B1-5-3
- Endplate/Fittings/Covers B1-5-3/11

# Tray Toepassingen

# Tray Applications

Tray

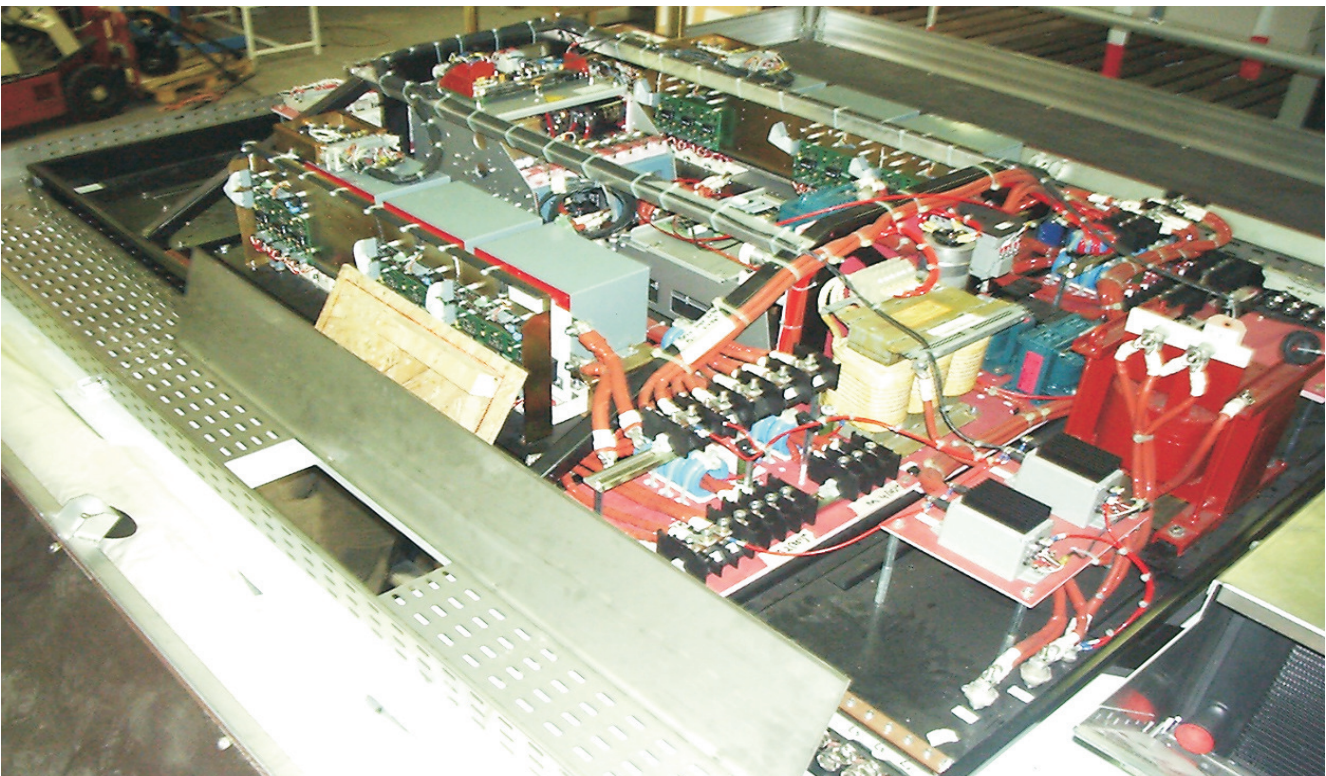
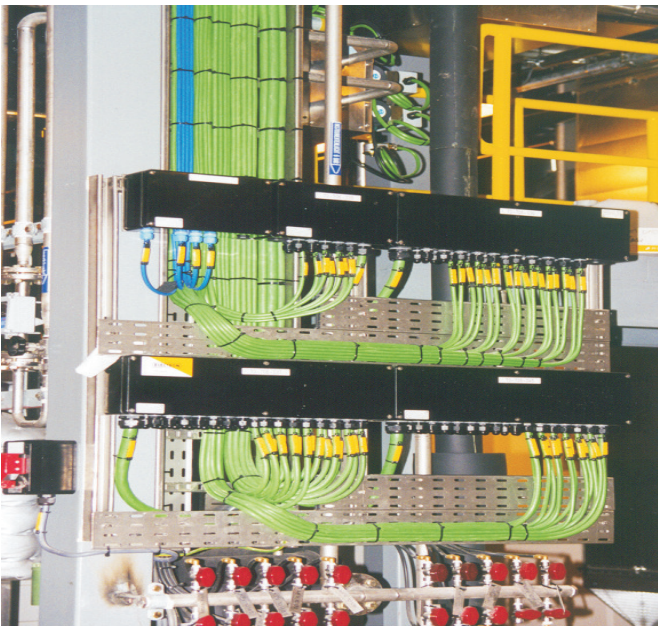

# Technische gegevens

# Technical specifications

## Kenmerken

## Features

### **Materiaal kwaliteit**

De kabelkanalen, koppelplaten, hulpstukken, deksels alsmede de ophang-inrichtingen worden vervaardigd uit roestvaststaal in de kwaliteit AISI 304 of AISI 316 met een 2B finish. De bevestigingsmaterialen zijn van A4 handels-kwaliteit.

### **Systeem**

Tray is een "light duty" geperforeerd vlakbodemsysteem. Tray wordt geleverd in lengten van 3000 mm en zijn in type H28/28R, H53/53R, H78R en H103R verkrijgbaar.

Tray bevat doorlopende sleufperforaties in de lengterichting, aangebracht volgens de EMC richtlijnen. Het systeem is volledig afsluitbaar met deksels type R in combinatie met dekselveren, dekselklemmen of sluitbanden.

### **Hulpstukken**

Hulpstukken worden geleverd met een standaard radius van 60 mm. Het systeem kan worden gecompleteerd met diverse plafond- en wandbevestigingen (zie hoofdstuk **E**).

### **Material Quality**

*The cable ducts, splice plates, fittings, covers and suspension constructions are fabricated in stainless steel, quality AISI 304 or AISI 316 with a 2B finish. The attachment materials are made of A4 quality.*

### **System**

*Tray is a "light duty" perforated cable duct system. Tray is supplied in lengths of 3000 mm and are for type H28/28R, H53/53R, H78R and H103R available.*

*Tray has a continuous row of slotted perforations lengthwise, in accordance with EMC-standards. The system is completely lockable with covers type R in combination with cover springs, cover clamps or fasteners.*

### **Fittings**

*Fittings are supplied with a standard radius of 60 mm. The system can be completed with several ceiling- and wall-attachments (see chapter **E**).*

# Technische gegevens

# Technical specifications

Overspanningsklasse en belastbaarheid

Span category and load-bearing capacity

Tray

## Belastbaarheid

Tray is belastbaar volgens de in de tabellen opgenomen gegevens. Om het draagvermogen te handhaven op plaatsen waar hulpstukken bevestigd zitten, moeten daar extra steunpunten worden aangebracht.

## Overspanningsklasse

Tray kan, met inachtneming van de maximale belastbaarheid, worden toegepast over een afstand van maximaal 3000 mm.

## Maatwerk

Speciale materialen en maatvoeringen kunnen op klant specificaties gefabriceerd worden.

## Belastinggrafiek

Bij: - gelijkmatige belasting  
- doorbuiging van max. 1/300  
- belasting van ca. 100 N per 100 mm kabelkanaalbreedte.

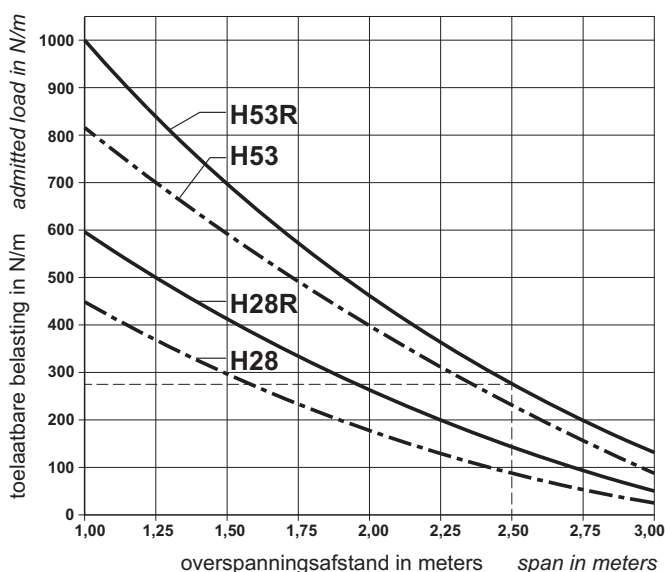

NB: Bij de gevonden overspanningen moeten - gemeten vanuit de ondersteuning - de koppelingen plaatsvinden binnen een kwart van de overspanning.

## Load-bearing Capacity

Tray can be loaded within the limits indicated in the carrying capacity tables. In order to maintain the carrying capacity, additional support points are needed where fittings have been applied.

## Span Category

Tray can be installed over a maximum distance of 3000 mm.

## Custom-made goods

Special materials and sizes can be made-to-measure on customer request.

## Loading diagrams

With: - uniform load  
- deflection of max. 1/300  
- load of max. 100 N per 100 mm cable duct width.

Voorbeeld:  
Kabelkanaal H53R 250 mm breed.  
Belasting is dan ca. 250 N/m.  
Eigen gewicht per meter ca. 30 N/m.  
Totale belasting ca. 280 N/m.  
Max. overspanning is dan 2,5 meter.  
(zie grafiek)

Example:  
Cable duct H53R 250 mm wide.  
Load in this case about 250 N/m.  
Duct weight per meter about 30 N/m.  
Total load about 280 N/m.  
Max. span in this case 2,5 meter.  
(see diagram)

NB: In case of found spans, optimum splice locations are at approximate quarter-points (one-fourth the clear span distance) from the support.

# Systemoverzicht Tray

# Survey of the system Tray

Benaming / Description	H28(R)		H53(R)	
	pos. nr. item no.	pagina page	pos. nr. item no.	pagina page
Kabelkanaal zonder omzetrans / Cable duct without flange	1	B1-2-1	18	B1-3-1
Kabelkanaal met omzetrans / Cable duct with flange	2	B1-2-1	19	B1-3-1
Koppelplaat / Splice plate	3	B1-2-2	20	B1-3-2
Scharnierende koppelplaat / Hinged splice plate	4	B1-2-2	21	B1-3-2
Scheidingsschot / Separation strip	5	B1-2-2	22	B1-3-2
Eindschot-verlooppkoppelplaat / Endplate-reducing splice plate	6	B1-2-3	23	B1-3-3
Verloopstuk / Reducer	7	B1-2-3	24	B1-3-3
Aanzethoekstuk / Universal corner piece	8	B1-2-3	25	B1-3-3
Hoekstuk 45° / Corner piece 45°	9	B1-2-4	26	B1-3-4
Hoekstuk 90° / Corner piece 90°	10	B1-2-4	27	B1-3-4
Aftakstuk / Branch	11	B1-2-5	28	B1-3-5
Driewegstuk (gelijkzijdig) / Equal tee piece	12	B1-2-5/6	29	B1-3-5/6
Vierwegstuk / Cross piece	13	B1-2-7	30	B1-3-7
Stijgstuk 45° / Vertical inner bend 45°	14	B1-2-8	31	B1-3-8
Stijgstuk 90° / Vertical inner bend 90°	15	B1-2-8	32	B1-3-8
Vervalstuk 45° / Vertical outer bend 45°	16	B1-2-9	33	B1-3-9
Vervalstuk 90° / Vertical outer bend 90°	17	B1-2-9	34	B1-3-9
Montagerail / Hanger channel	35	E	35	E
Plafondbeugel-L / Ceiling brace-L	36	E	36	E
Railplaat / Rail plate	37	E	37	E
Moerplaat / Nut plate	38	E	38	E
Open ophangbeugel / Open suspension bracket	39	E	39	E
Open ophangbeugel-L / Open suspension bracket-L	40	E	40	E
Console-L / Bracket-L	41	E	41	E
Console-M / Bracket-M	42	E	42	E
Dekselklem / Cover clamp	43	B1-3-2	43	B1-3-2
Dekselveer / Cover spring	44	B1-3-2	44	B1-3-2
Universele montageplaat / Mounting plate for socket box	45	-	45	E
Borgbeugel / Fixing brace	46	E	46	E
Spanklauw-B / Beam clamp-B	47	E	47	E

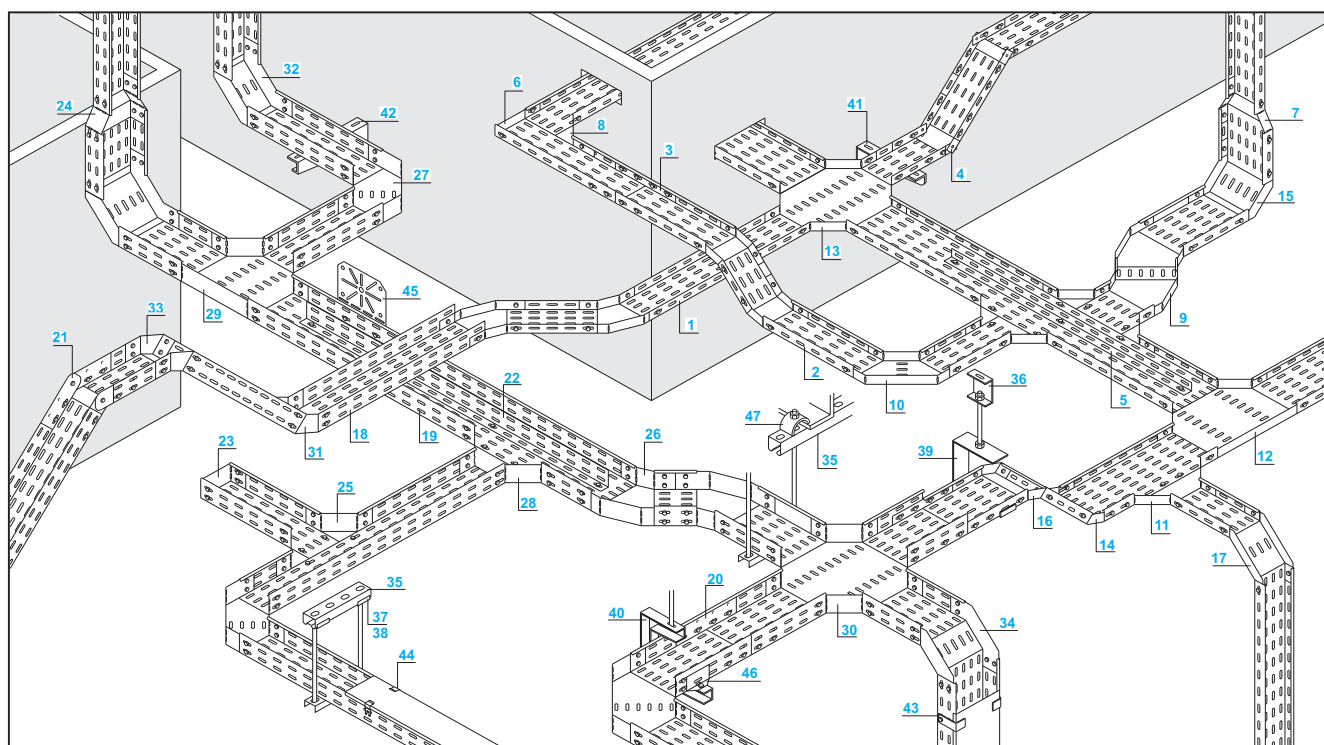

# Tray

## H28

## H28R

Kabelkanaal H28  
Cable duct H28

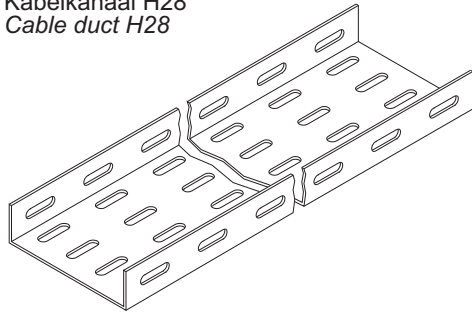

Kabelkanaal H28R  
Cable duct H28R

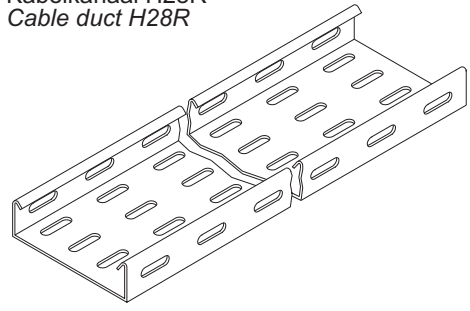

Tray

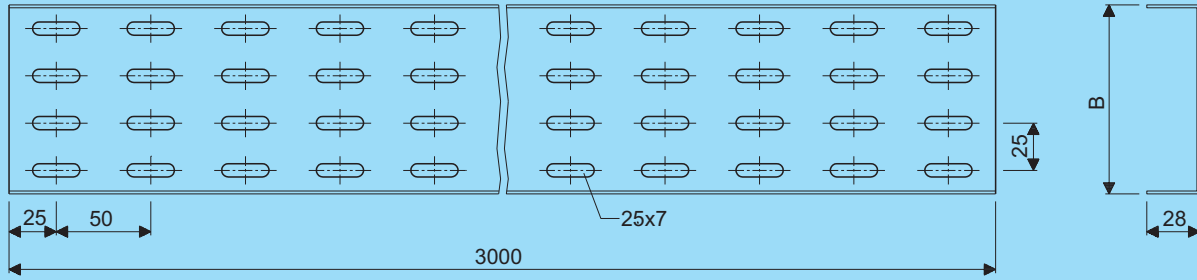

Kabelkanaal H28 Cable duct H28			
B	Artikel nr. Product no.		Gewicht Weight
	AISI 304	AISI 316	
50	31041.154	31041.156	1,97
75	31042.154	31042.156	2,46
100	31043.154	31043.156	2,95
150	31044.154	31044.156	3,94
200	31045.154	31045.156	4,92
250	31046.154	31046.156	5,90
300	31047.154	31047.156	6,89

sleufperforatie in de lengterichting in verband met EMC  
perforation slots lengthways in view of EMC

bestel de benodigde koppelplaten apart, zij worden niet geleverd bij de kanalen

order splice plates as separate items, they are not supplied with the cable ducts

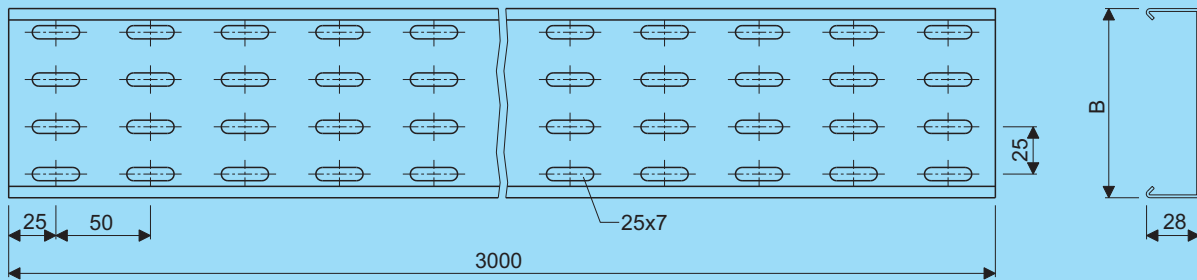

Kabelkanaal H28R Cable duct H28R			
B	Artikel nr. Product no.		Gewicht Weight
	AISI 304	AISI 316	
50	31081.154	31081.156	2,30
75	31082.154	31082.156	2,80
100	31083.154	31083.156	3,29
150	31084.154	31084.156	4,27
200	31085.154	31085.156	5,26
250	31086.154	31086.156	6,24
300	31087.154	31087.156	7,22

sleufperforatie in de lengterichting in verband met EMC  
perforation slots lengthways in view of EMC

bestel de benodigde koppelplaten apart, zij worden niet geleverd bij de kanalen

order splice plates as separate items, they are not supplied with the cable ducts



# Tray H28

Koppelplaat  
Splice plate

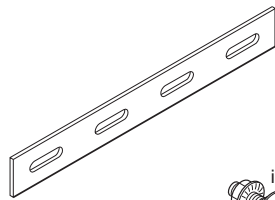

incl.  
4x

Scharnierende koppelplaat  
Hinged splice plate

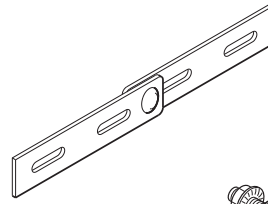

incl.  
5x

Scheidingsshot  
Separation strip

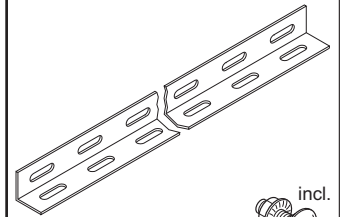

incl.  
4x

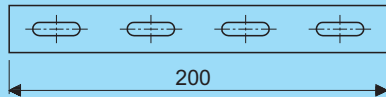

Koppelplaat Splice plate		
Artikel nr. Product no.		Gewicht Weight
AISI 304	AISI 316	
31122.154	31122.156	

levering inclusief:  
4 slotbouten M6 x12  
en flensmoeren

supplied complete with:  
4 lock screws M6 x 12  
and flange nuts

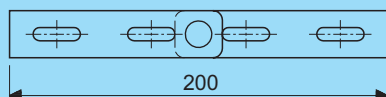

Scharnierende koppelplaat Hinged splice plate		
Artikel nr. Product no.		Gewicht Weight
AISI 304	AISI 316	
31141.154	31141.156	

levering inclusief:  
5 slotbouten M6 x12  
en flensmoeren

supplied complete with:  
5 lock screws M6 x 12  
and flange nuts

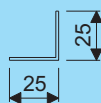
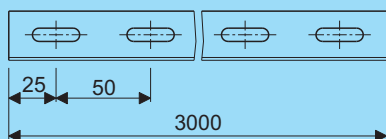

Scheidingsshot Separation strip		
Artikel nr. Product no.		Gewicht Weight
AISI 304	AISI 316	
98721.154	98721.156	

levering inclusief:  
4 slotbouten M6 x12  
en flensmoeren

supplied complete with:  
4 lock screws M6 x 12  
and flange nuts

# Tray H28

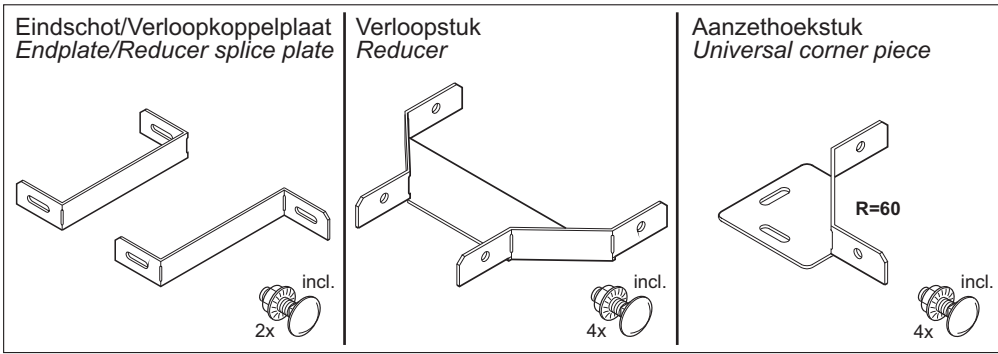

Tray

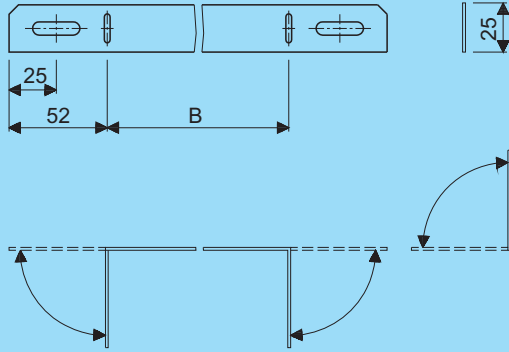

Eindschot/Verlooppkoppelplaat Endplate/Reducer splice plate			
B	Artikel nr. Product no.		Gewicht Weight
	AISI 304	AISI 316	
25	31170.154	31170.156	0,04
50	31171.154	31171.156	0,04
75	31172.154	31172.156	0,05
100	31173.154	31173.156	0,05
150	31174.154	31174.156	0,06
200	31175.154	31175.156	0,07
250	31176.154	31176.156	0,08
300	31177.154	31177.156	0,09

levering inclusief:  
2 slotbouten M6 x12  
en flensmoeren

supplied complete with:  
2 lock screws M6 x 12  
and flange nuts

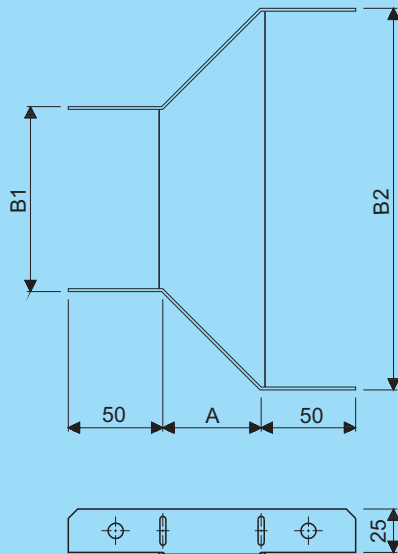

Verloopstuk Reducer				
A	B1-B2	Artikel nr. Product no.		Gewicht Weight
		AISI 304	AISI 316	
47	50- 75	31191.154	31191.156	0,12
44	50-100	31192.154	31192.156	0,13
34	50-150	31193.154	31193.156	0,14
47	75-100	31194.154	31194.156	0,13
38	75-150	31195.154	31195.156	0,14
63	75-200	31196.154	31196.156	0,17
44	100-150	31197.154	31197.156	0,15
50	100-200	31198.154	31198.156	0,16
75	100-250	31199.154	31199.156	0,21
44	150-200	31200.154	31200.156	0,16
50	150-250	31201.154	31201.156	0,18
75	150-300	31202.154	31202.156	0,24
44	200-250	31203.154	31203.156	0,18
50	200-300	31204.154	31204.156	0,20
44	250-300	31206.154	31206.156	0,19

levering inclusief:  
4 slotbouten M6 x12  
en flensmoeren

supplied complete with:  
4 lock screws M6 x 12  
and flange nuts

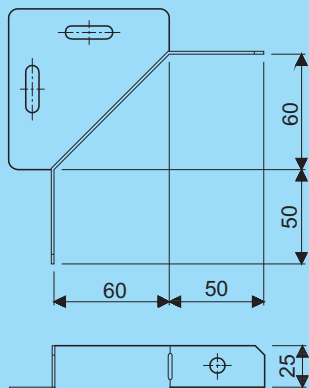

Aanzethoekstuk Universal corner piece		
Artikel nr. Product no.		Gewicht Weight
AISI 304	AISI 316	
31221.154	31221.156	0,07

levering inclusief:  
4 slotbouten M6 x12  
en flensmoeren

supplied complete with:  
4 lock screws M6 x 12  
and flange nuts

# Tray H28

Hoekstuk 45°  
Corner piece 45°

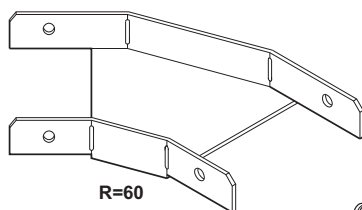

R=60



Hoekstuk 90°  
Corner piece 90°

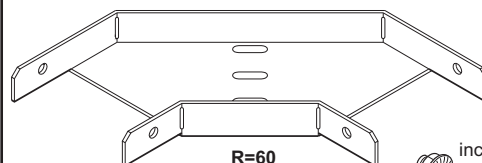

R=60

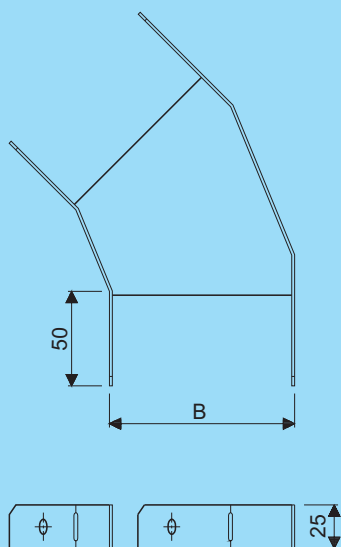

Hoekstuk 45° Corner piece 45°			
B	Artikel nr. Product no.		Gewicht Weight
	AISI 304	AISI 316	
50	31241.154	31241.156	0,07
75	31242.154	31242.156	0,11
100	31243.154	31243.156	0,14
150	31244.154	31244.156	0,21
200	31245.154	31245.156	0,28
250	31246.154	31246.156	0,38
300	31247.154	31247.156	0,50

levering inclusief:  
4 slotbouten M6 x 12  
en flensmoeren

supplied complete with:  
4 lock screws M6 x 12  
and flange nuts

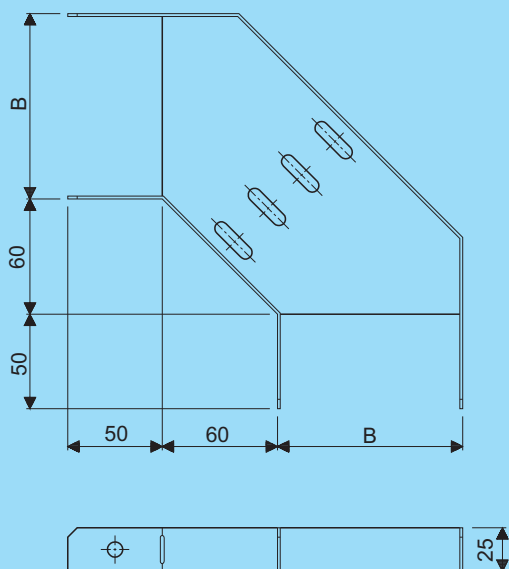

Hoekstuk 90° Corner piece 90°			
B	Artikel nr. Product no.		Gewicht Weight
	AISI 304	AISI 316	
50	31261.154	31261.156	0,16
75	31262.154	31262.156	0,20
100	31263.154	31263.156	0,25
150	31264.154	31264.156	0,29
200	31265.154	31265.156	0,45
250	31266.154	31266.156	0,69
300	31267.154	31267.156	0,88

levering inclusief:  
4 slotbouten M6 x 12  
en flensmoeren

supplied complete with:  
4 lock screws M6 x 12  
and flange nuts

# Tray H28

Aftakstuk  
Branch

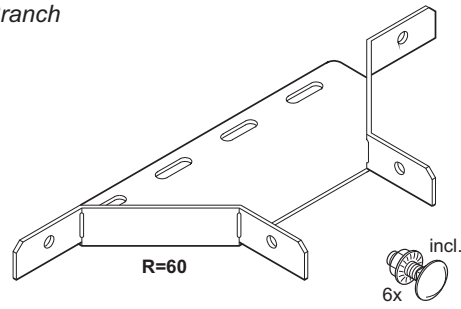

Driewegstuk (gelijkzijdig)  
Equal tee piece

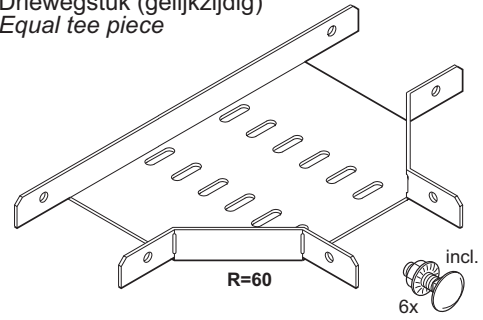

Tray

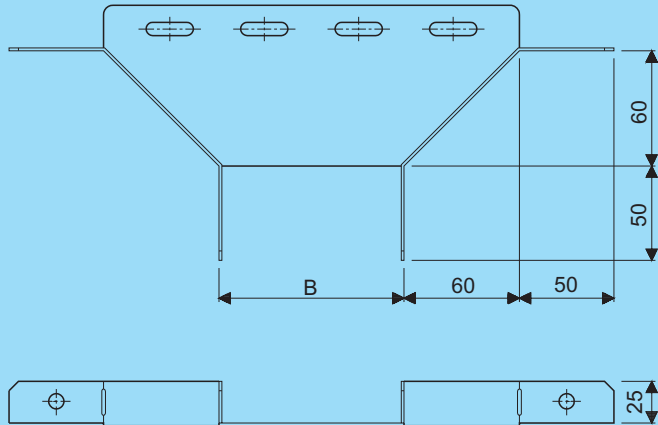

Aftakstuk Branch			
B	Artikel nr. Product no.		Gewicht Weight
	AISI 304	AISI 316	
50	31281.154	31281.156	0,17
75	31282.154	31282.156	0,19
100	31283.154	31283.156	0,20
150	31284.154	31284.156	0,24
200	31285.154	31285.156	0,27
250	31286.154	31286.156	0,30
300	31287.154	31287.156	0,33

levering inclusief:  
6 slotbouten M6 x 12  
en flensmoeren

supplied complete with:  
6 lock screws M6 x 12  
and flange nuts

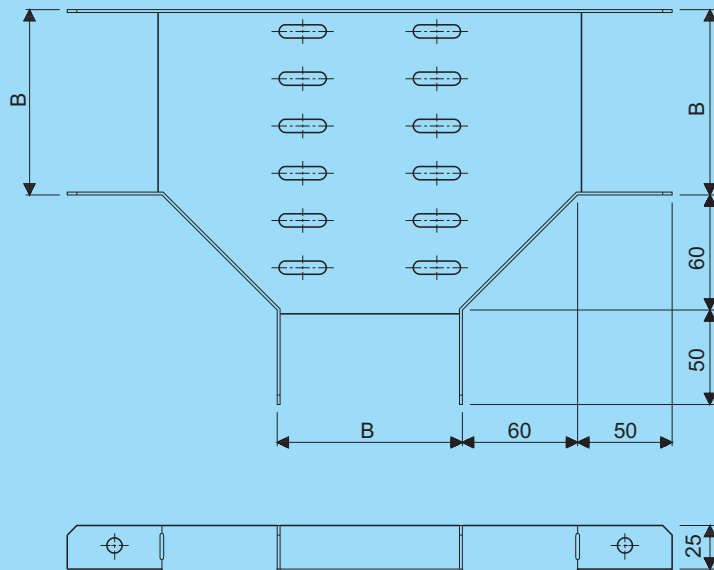

Driewegstuk (gelijkzijdig) Equal tee piece			
B	Artikel nr. Product no.		Gewicht Weight
	AISI 304	AISI 316	
50	31301.154	31301.156	0,27
75	31302.154	31302.156	0,33
100	31303.154	31303.156	0,40
150	31304.154	31304.156	0,57
200	31305.154	31305.156	0,79
250	31306.154	31306.156	1,04
300	31307.154	31307.156	1,34

levering inclusief:  
6 slotbouten M6 x 12  
en flensmoeren

supplied complete with:  
6 lock screws M6 x 12  
and flange nuts

# Tray H28

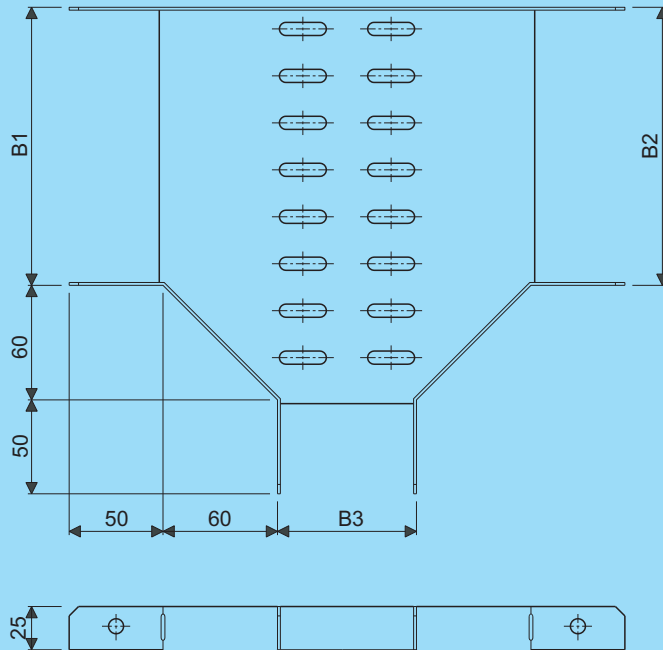
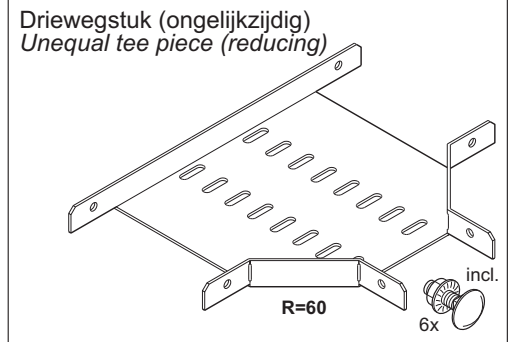

Driewegstuk (ongelijkzijdig) Unequal tee piece (reducing)			
B1-B2-B3	Artikel nr. Product no.		Gewicht Weight
	AISI 304	AISI 316	
75- 75- 50	31321.154	31321.156	0,30
100-100- 50	31322.154	31322.156	0,33
100-100- 75	31323.154	31323.156	0,36
150-150- 50	31324.154	31324.156	0,39
150-150- 75	31325.154	31325.156	0,43
150-150-100	31326.154	31326.156	0,48
200-200- 50	31327.154	31327.156	0,45
200-200- 75	31328.154	31328.156	0,50
200-200-100	31329.154	31329.156	0,56
200-200-150	31330.154	31330.156	0,67
250-250- 50	31331.154	31331.156	0,51
250-250- 75	31332.154	31332.156	0,58
250-250-100	31333.154	31333.156	0,64
250-250-150	31334.154	31334.156	0,78
250-250-200	31335.154	31335.156	0,91
300-300- 50	31336.154	31336.156	0,57
300-300- 75	31337.154	31337.156	0,65
300-300-100	31338.154	31338.156	0,72
300-300-150	31339.154	31339.156	0,88
300-300-200	31340.154	31340.156	1,03
300-300-250	31341.154	31341.156	1,19

levering inclusief:  
6 slotbouten M6 x 12  
en flensmoeren

supplied complete with:  
6 lock screws M6 x 12  
and flange nuts

# Tray H28

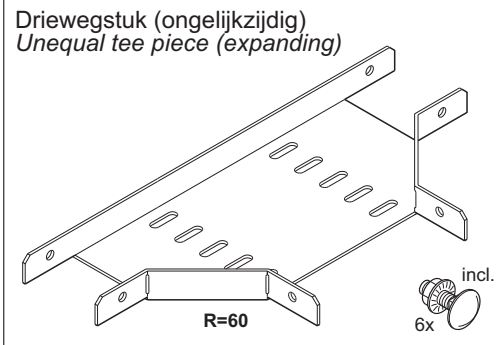

Tray

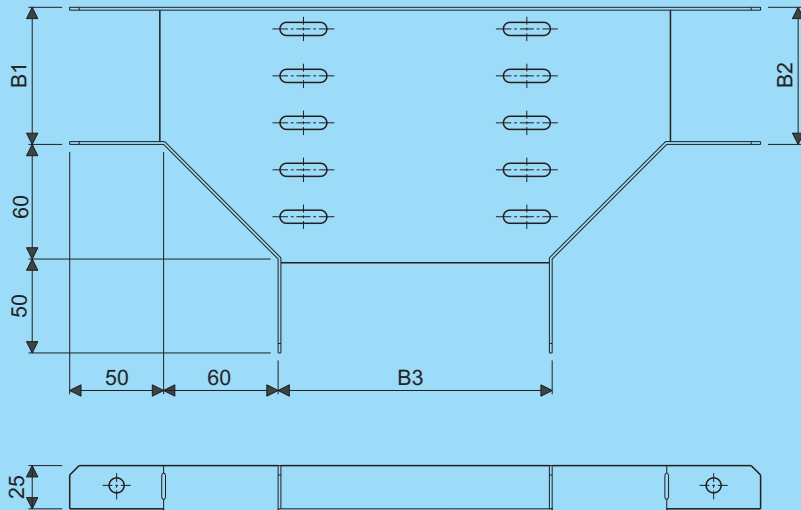

Driewegstuk (ongelijkzijdig) Unequal tee piece (expanding)			
B1-B2-B3	Artikel nr. Product no.		Gewicht Weight
	AISI 304	AISI 316	
50- 50- 75	31361.154	31361.156	0,29
50- 50-100	31362.154	31362.156	0,32
50- 50-150	31363.154	31363.156	0,37
50- 50-200	31364.154	31364.156	0,43
50- 50-250	31365.154	31365.156	0,48
50- 50-300	31366.154	31366.156	0,53
75- 75-100	31367.154	31367.156	0,36
75- 75-150	31368.154	31368.156	0,42
75- 75-200	31369.154	31369.156	0,48
75- 75-250	31370.154	31370.156	0,55
75- 75-300	31371.154	31371.156	0,61
100-100-150	31372.154	31372.156	0,47
100-100-200	31373.154	31373.156	0,54
100-100-250	31374.154	31374.156	0,61
100-100-300	31375.154	31375.156	0,69
150-150-200	31376.154	31376.156	0,66
150-150-250	31377.154	31377.156	0,75
150-150-300	31378.154	31378.156	0,85
200-200-250	31379.154	31379.156	0,89
200-200-300	31380.154	31380.156	1,01
250-250-300	31381.154	31381.156	1,17

levering inclusief:  
6 slotbouten M6 x 12  
en flensmoeren

supplied complete with:  
6 lock screws M6 x 12  
and flange nuts

# Tray H28

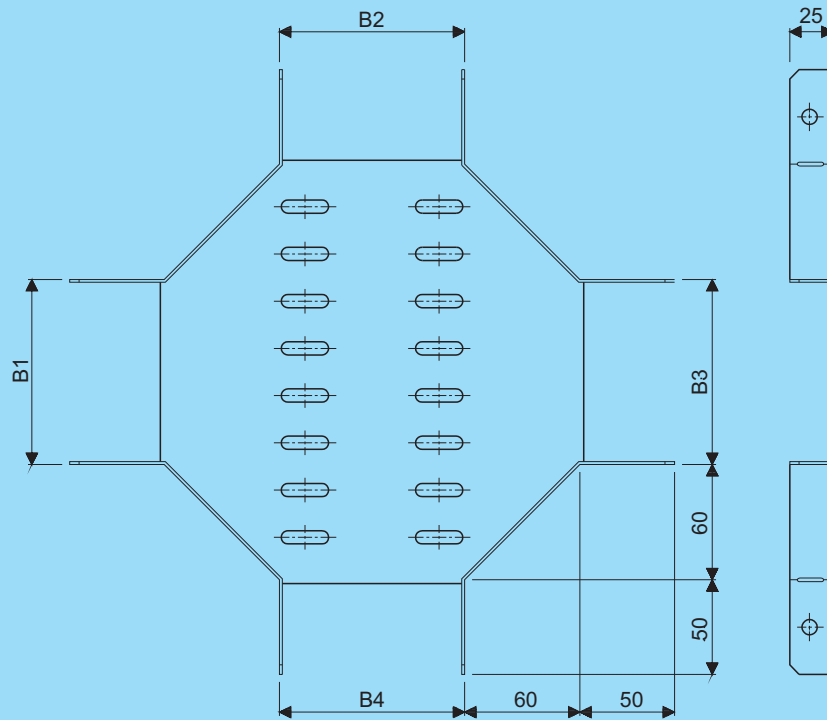
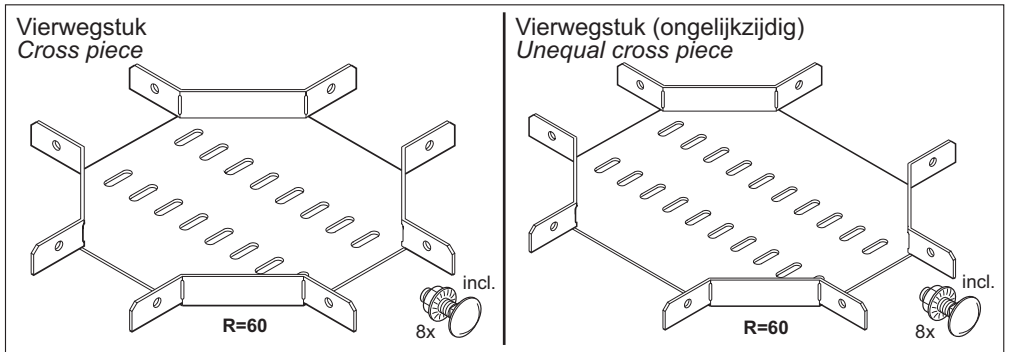

Vierwegstuk Cross piece			
B1-B2-B3-B4	Artikel nr. Product no.		Gewicht Weight
	AISI 304	AISI 316	
50- 50- 50- 50	31401.154	31401.156	0,37
75- 75- 75- 75	31402.154	31402.156	0,42
100-100-100-100	31403.154	31403.156	0,50
150-150-150-150	31404.154	31404.156	0,69
200-200-200-200	31405.154	31405.156	0,92
250-250-250-250	31406.154	31406.156	1,19
300-300-300-300	31407.154	31407.156	1,50
75- 50- 75- 50	31421.154	31421.156	0,40
100- 50-100- 50	31422.154	31422.156	0,43
100- 75-100- 75	31423.154	31423.156	0,46
150- 50-150- 50	31424.154	31424.156	0,47
150- 75-150- 75	31425.154	31425.156	0,53
150-100-150-100	31426.154	31426.156	0,58
200- 50-200- 50	31427.154	31427.156	0,53
200- 75-200- 75	31428.154	31428.156	0,60
200-100-200-100	31429.154	31429.156	0,66
200-150-200-150	31430.154	31430.156	0,79
250- 50-250- 50	31431.154	31431.156	0,60
250- 75-250- 75	31432.154	31432.156	0,67
250-100-250-100	31433.154	31433.156	0,74
250-150-250-150	31434.154	31434.156	0,89
250-200-250-200	31435.154	31435.156	1,04
300- 50-300- 50	31436.154	31436.156	0,66
300- 75-300- 75	31437.154	31437.156	0,74
300-100-300-100	31438.154	31438.156	0,82
300-150-300-150	31439.154	31439.156	0,99
300-200-300-200	31440.154	31440.156	1,16
300-250-300-250	31441.154	31441.156	1,33

levering inclusief:  
8 slotbouten M6 x 12  
en flensmoeren

supplied complete with:  
8 lock screws M6 x 12  
and flange nuts

# Tray H28

Stijgstuk 45°  
Vertical inner bend 45°

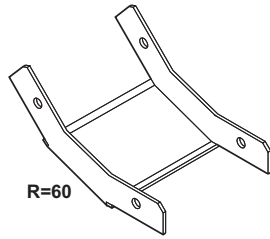

R=60



Stijgstuk 90°  
Vertical inner bend 90°

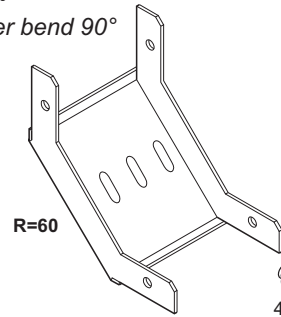

R=60



Tray

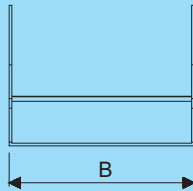
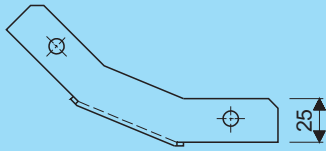

Stijgstuk 45° Vertical inner bend 45°			
B	Artikel nr. Product no.		Gewicht Weight
	AISI 304	AISI 316	
50	31461.154	31461.156	0,12
75	31462.154	31462.156	0,13
100	31463.154	31463.156	0,15
150	31464.154	31464.156	0,17
200	31465.154	31465.156	0,19
250	31466.154	31466.156	0,22
300	31467.154	31467.156	0,25

levering inclusief:  
4 slotbouten M6 x 12  
en flensmoeren

supplied complete with:  
4 lock screws M6 x 12  
and flange nuts

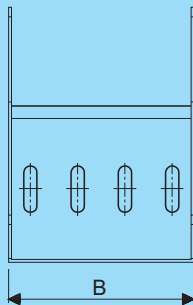
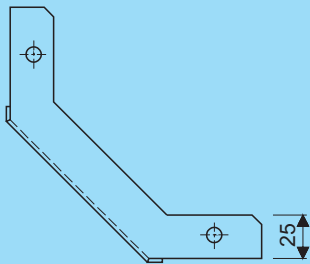

Stijgstuk 90° Vertical inner bend 90°			
B	Artikel nr. Product no.		Gewicht Weight
	AISI 304	AISI 316	
50	31481.154	31481.156	0,15
75	31482.154	31482.156	0,17
100	31483.154	31483.156	0,19
150	31484.154	31484.156	0,24
200	31485.154	31485.156	0,29
250	31486.154	31486.156	0,33
300	31487.154	31487.156	0,38

levering inclusief:  
4 slotbouten M6 x 12  
en flensmoeren

supplied complete with:  
4 lock screws M6 x 12  
and flange nuts



# Tray H28

Vervalstuk 45°  
Vertical outer bend 45°

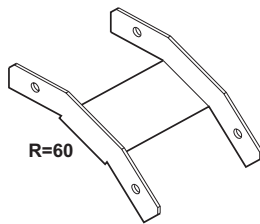

incl.  
4x

Vervalstuk 90°  
Vertical outer bend 90°

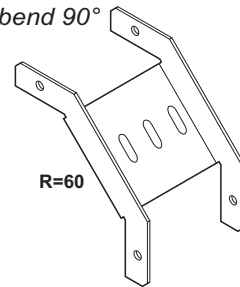

incl.  
4x

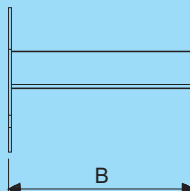
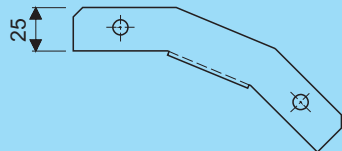

Vervalstuk 45° Vertical outer bend 45°			
B	Artikel nr. Product no.		Gewicht Weight
	AISI 304	AISI 316	
50	31501.154	31501.156	0,11
75	31502.154	31502.156	0,11
100	31503.154	31503.156	0,13
150	31504.154	31504.156	0,15
200	31505.154	31505.156	0,16
250	31506.154	31506.156	0,18
300	31507.154	31507.156	0,20

levering inclusief:  
4 slotbouten M6 x 12  
en flensmoeren

supplied complete with:  
4 lock screws M6 x 12  
and flange nuts

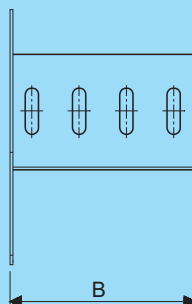
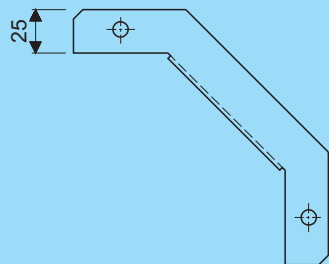

Vervalstuk 90° Vertical outer bend 90°			
B	Artikel nr. Product no.		Gewicht Weight
	AISI 304	AISI 316	
50	31521.154	31521.156	0,13
75	31522.154	31522.156	0,15
100	31523.154	31523.156	0,16
150	31524.154	31524.156	0,19
200	31525.154	31525.156	0,22
250	31526.154	31526.156	0,25
300	31527.154	31527.156	0,28

levering inclusief:  
4 slotbouten M6 x 12  
en flensmoeren

supplied complete with:  
4 lock screws M6 x 12  
and flange nuts

# Tray

## H53

## H53R



Det Norske Veritas (DNV) en Germanischer Lloyd (GL)

Kabelkanaal H53  
Cable duct H53

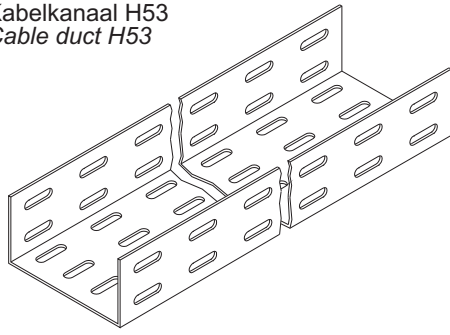

Kabelkanaal H53R  
Cable duct H53R

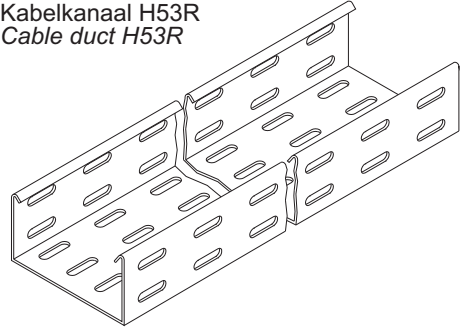

Tray

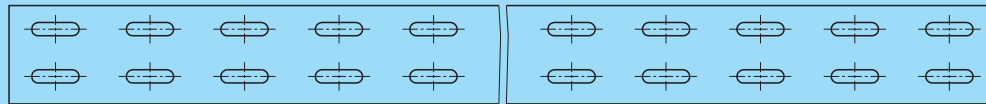
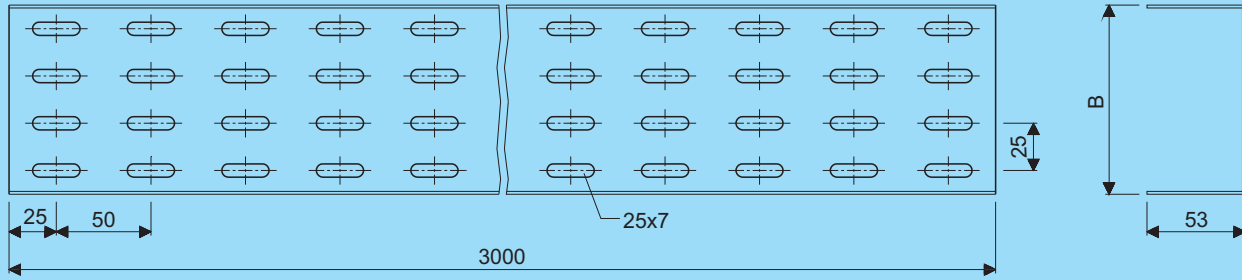

Kabelkanaal H53 Cable duct H53			
B	Artikel nr. Product no.		Gewicht Weight
	AISI 304	AISI 316	
50	32041.154	32041.156	2,95
75	32042.154	32042.156	3,44
100	32043.154	32043.156	3,94
150	32044.154	32044.156	4,92
200	32045.154	32045.156	5,90
250	32046.154	32046.156	6,89
300	32047.154	32047.156	7,87

sleufperforatie in de lengterichting in verband met EMC  
perforation slots lengthways in view of EMC

bestel de benodigde koppelplaten apart, zij worden niet geleverd bij de kanalen

order splice plates as separate items, they are not supplied with the cable ducts

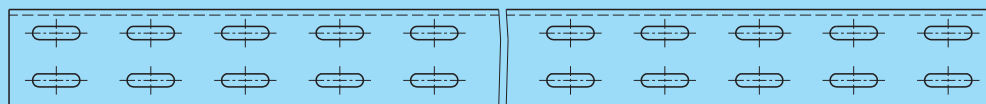
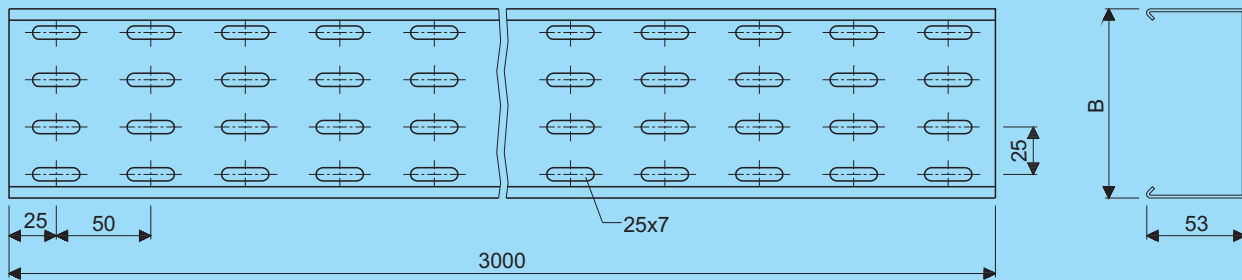

Kabelkanaal H53R Cable duct H53R			
B	Artikel nr. Product no.		Gewicht Weight
	AISI 304	AISI 316	
50	32081.154	32081.156	3,29
75	32082.154	32082.156	3,78
100	32083.154	32083.156	4,27
150	32084.154	32084.156	5,26
200	32085.154	32085.156	6,24
250	32086.154	32086.156	7,22
300	32087.154	32087.156	8,21

Kabelkanaaldeksel Cable duct cover			
B	Artikel nr. Product no.		Gewicht Weight
	AISI 304	AISI 316	
50	35041.144	35041.146	1,70
75	35042.144	35042.146	2,30
100	35043.144	35043.146	2,90
150	35044.144	35044.146	4,10
200	35045.144	35045.146	5,30
250	35046.144	35046.146	6,50
300	35047.144	35047.146	7,70

sleufperforatie in de lengterichting in verband met EMC  
perforation slots lengthways in view of EMC

bestel de benodigde koppelplaten apart, zij worden niet geleverd bij de kanalen

order splice plates as separate items, they are not supplied with the cable ducts

**Dekselveer**  
Cover spring

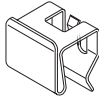

Det Norske Veritas (DNV) en Germanischer Lloyd (GL)

**Dekselklem**  
Cover clamp

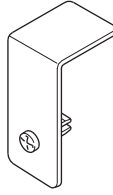

Det Norske Veritas (DNV) en Germanischer Lloyd (GL)

**Sluitband met tape**  
Fastener with tape

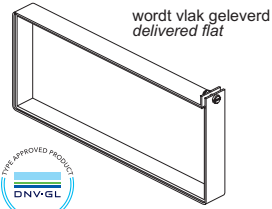

min. 1 st. per meter  
min. 1 pc. per meter

**Sluitband zonder tape**  
Fastener without tape

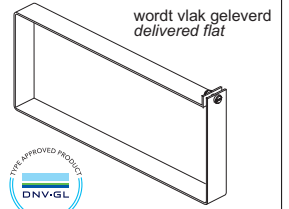

min. 1 st. per meter  
min. 1 pc. per meter

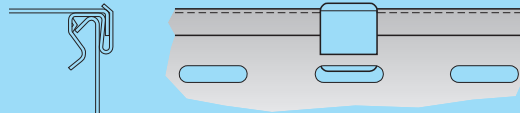
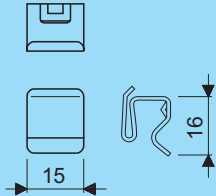

**montage-toepassing**  
mounting application

Dekselveer Cover spring	
Artikel nr. Product no.	Gewicht Weight
99983.209	0,002

bestel de benodigde deksel-  
veren apart, zij worden niet  
geleverd bij de deksels  
*kindly order cover springs as  
a separate item, they are  
not supplied with the covers*

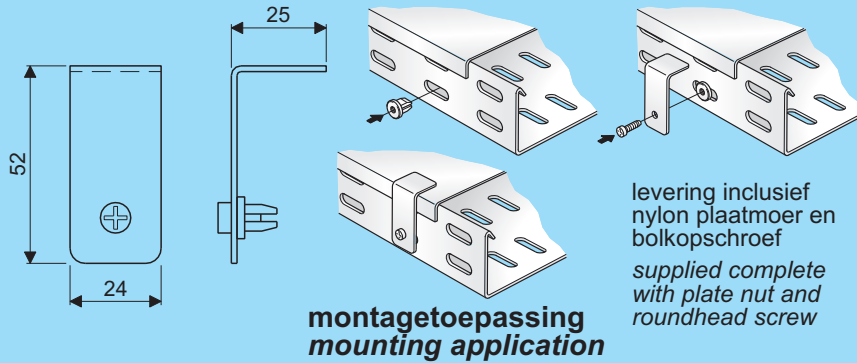

Dekselklem Cover clamp		
Artikel nr. Product no.		Gewicht Weight
AISI 304	AISI 316	0,02
99984.204	99984.206	

bestel de benodigde deksel-  
klemmen apart, zij worden  
niet geleverd bij de deksels  
*kindly order cover clamps as  
a separate item, they are  
not supplied with the covers*

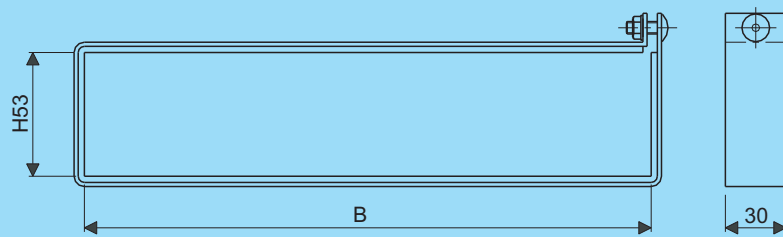

B	Artikel nr. Product no.		Gewicht Weight
	AISI 304	AISI 316	
50	32601.154	32601.156	0,05
75	32602.154	32602.156	0,06
100	32603.154	32603.156	0,08
150	32604.154	32604.156	0,10
200	32605.154	32605.156	0,12
250	32606.154	32606.156	0,15
300	32607.154	32607.156	0,17

levering inclusief: *supplied complete with:*  
1 slotbout M6 x 12 *1 lock screw M6 x 12*  
en flensmoer *and flange nut*

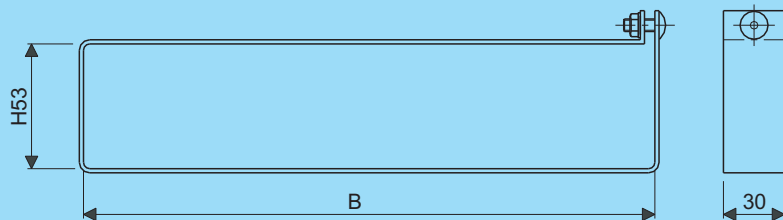

B	Artikel nr. Product no.		Gewicht Weight
	AISI 304	AISI 316	
50	32611.154	32611.156	0,05
75	32612.154	32612.156	0,06
100	32613.154	32613.156	0,08
150	32614.154	32614.156	0,10
200	32615.154	32615.156	0,12
250	32616.154	32616.156	0,15
300	32617.154	32617.156	0,17

levering inclusief: *supplied complete with:*  
1 slotbout M6 x 12 *1 lock screw M6 x 12*  
en flensmoer *and flange nut*

**Koppelplaat**  
*Splice plate*



Det Norske Veritas (DNV) en Germanischer Lloyd (GL)

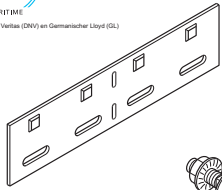

incl.  
4x

**Scharnierende koppelplaat**  
*Hinged splice plate*



Det Norske Veritas (DNV) en Germanischer Lloyd (GL)

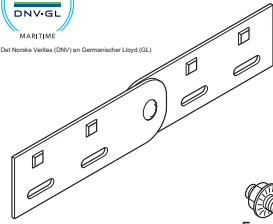

incl.  
5x

**Scheidingsschot**  
*Separation strip*



Det Norske Veritas (DNV) en Germanischer Lloyd (GL)

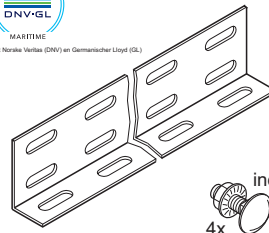

incl.  
4x

**Eindschot/Verloopkoppelplaat**  
*Endplate/Reducer splice plate*



Det Norske Veritas (DNV) en Germanischer Lloyd (GL)

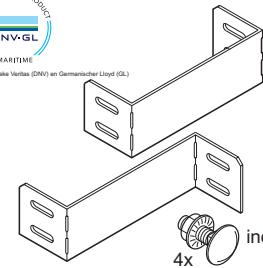

incl.  
4x

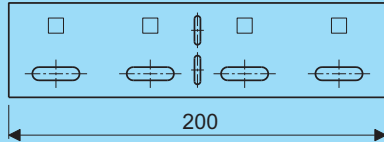

levering inclusief:  
4 slotbouten M6 x12  
en flensmoeren  
*supplied complete with:*  
4 lock screws M6 x 12  
and flange nuts

Koppelplaat <i>Splice plate</i>		
Artikel nr. <i>Product no.</i>		Gewicht <i>Weight</i>
AISI 304	AISI 316	
32132.154	32132.156	0,11

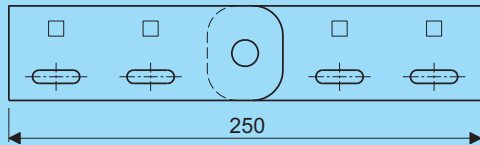

Scharnierende koppelplaat <i>Hinged splice plate</i>		
Artikel nr. <i>Product no.</i>		Gewicht <i>Weight</i>
AISI 304	AISI 316	
32151.154	32151.156	0,19

levering inclusief:  
5 slotbouten M6 x12  
en flensmoeren  
*supplied complete with:*  
5 lock screws M6 x 12  
and flange nuts

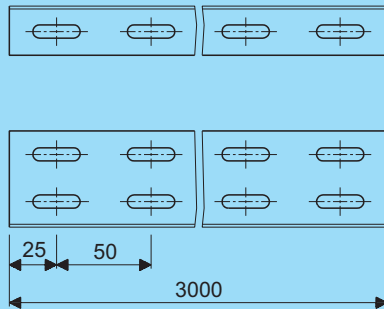

levering inclusief:  
4 slotbouten M6 x12  
en flensmoeren  
*supplied complete with:*  
4 lock screws M6 x 12  
and flange nuts

Scheidingsschot <i>Separation strip</i>		
Artikel nr. <i>Product no.</i>		Gewicht <i>Weight</i>
AISI 304	AISI 316	
98723.154	98723.156	1,53

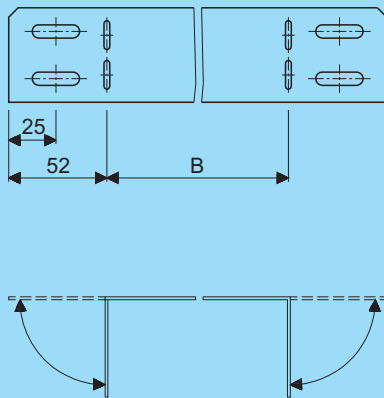

Eindschot/Verloopkoppelplaat <i>Endplate/Reducer splice plate</i>			
B	Artikel nr. <i>Product no.</i>		Gewicht <i>Weight</i>
	AISI 304	AISI 316	
25	32170.154	32170.156	0,11
50	32171.154	32171.156	0,12
75	32172.154	32172.156	0,13
100	32173.154	32173.156	0,14
150	32174.154	32174.156	0,16
200	32175.154	32175.156	0,18
250	32176.154	32176.156	0,20
300	32177.154	32177.156	0,22

levering inclusief:  
4 slotbouten M6 x12  
en flensmoeren  
*supplied complete with:*  
4 lock screws M6 x 12  
and flange nuts

# Tray H53



Det Norske Veritas (DNV) en Germanischer Lloyd (GL)

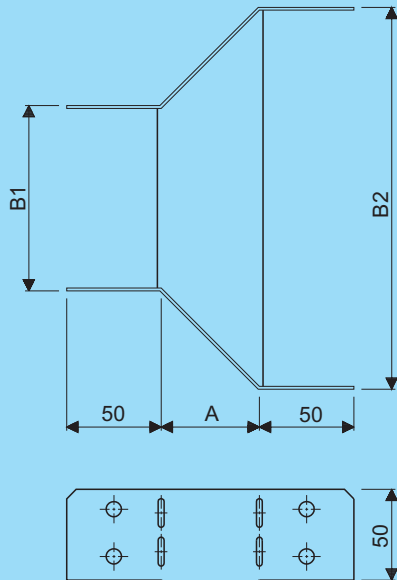
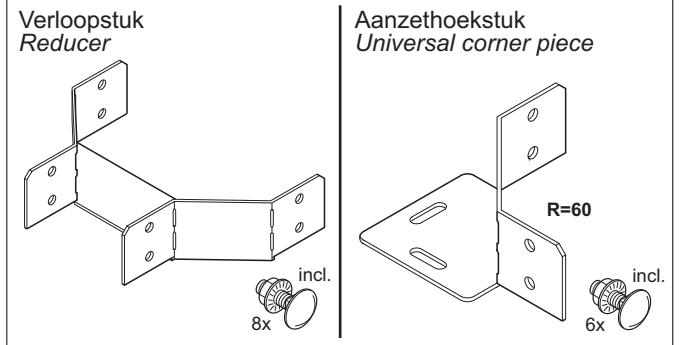

levering inclusief:  
8 slotbouten M6 x12  
en flensmoeren

supplied complete with:  
8 lock screws M6 x 12  
and flange nuts

Verloopstuk Reducer					Verloopstukdeksel Reducer cover		
A	B1-B2	Artikel nr. Product no.		Gewicht Weight	Artikel nr. Product no.		Gewicht Weight
		AISI 304	AISI 316		AISI 304	AISI 316	
47	50- 75	32191.154	32191.156	0,23	35191.144	35191.146	0,05
44	50-100	32192.154	32192.156	0,23	35192.144	35192.146	0,05
34	50-150	32193.154	32193.156	0,25	35193.144	35193.146	0,06
47	75-100	32194.154	32194.156	0,24	35194.144	35194.146	0,06
38	75-150	32195.154	32195.156	0,24	35195.144	35195.146	0,07
63	75-200	32196.154	32196.156	0,28	35196.144	35196.146	0,11
44	100-150	32197.154	32197.156	0,25	35197.144	35197.146	0,08
50	100-200	32198.154	32198.156	0,27	35198.144	35198.146	0,11
75	100-250	32199.154	32199.156	0,31	35199.144	35199.146	0,16
44	150-200	32200.154	32200.156	0,27	35200.144	35200.146	0,11
50	150-250	32201.154	32201.156	0,29	35201.144	35201.146	0,14
75	150-300	32202.154	32202.156	0,34	35202.144	35202.146	0,20
44	200-250	32203.154	32203.156	0,29	35203.144	35203.146	0,14
50	200-300	32204.154	32204.156	0,31	35204.144	35204.146	0,17
44	250-300	32206.154	32206.156	0,31	35206.144	35206.146	0,17

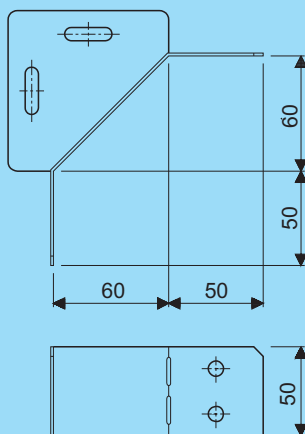

Aanzethoekstuk Universal corner piece		
Artikel nr. Product no.		Gewicht Weight
AISI 304	AISI 316	
32221.154	32221.156	0,16

levering inclusief:  
6 slotbouten M6 x12  
en flensmoeren

supplied complete with:  
6 lock screws M6 x 12  
and flange nuts

Hoekstuk 45°  
Corner piece 45°

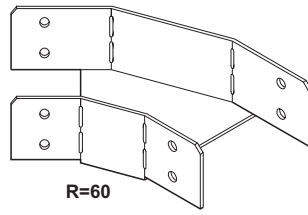

R=60



Hoekstuk 90°  
Corner piece 90°

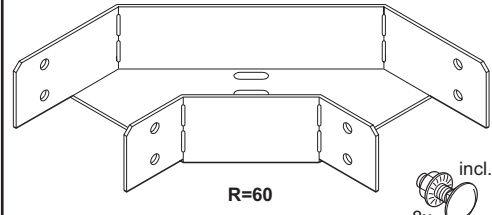

R=60

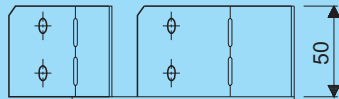
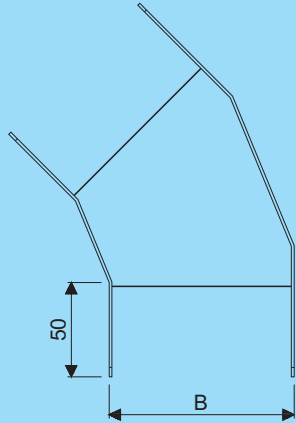

Hoekstuk 45° Corner piece 45°			
B	Artikel nr. Product no.		Gewicht Weight
	AISI 304	AISI 316	
50	32241.154	32241.156	0,24
75	32242.154	32242.156	0,24
100	32243.154	32243.156	0,27
150	32244.154	32244.156	0,34
200	32245.154	32245.156	0,45
250	32246.154	32246.156	0,56
300	32247.154	32247.156	0,68

Hoekstukdeksel 45° Corner piece cover 45°			
B	Artikel nr. Product no.		Gewicht Weight
	AISI 304	AISI 316	
50	35241.144	35241.146	0,05
75	35242.144	35242.146	0,07
100	35243.144	35243.146	0,10
150	35244.144	35244.146	0,17
200	35245.144	35245.146	0,26
250	35246.144	35246.146	0,36
300	35247.144	35247.146	0,48

levering inclusief:  
8 slotbouten M6 x 12  
en flensmoeren

supplied complete with:  
8 lock screws M6 x 12  
and flange nuts

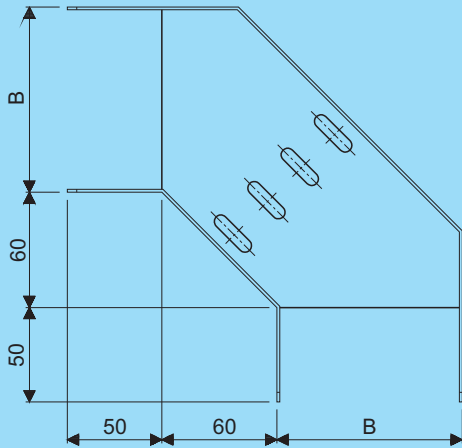

Hoekstuk 90° Corner piece 90°			
B	Artikel nr. Product no.		Gewicht Weight
	AISI 304	AISI 316	
50	32261.154	32261.156	0,28
75	32262.154	32262.156	0,33
100	32263.154	32263.156	0,39
150	32264.154	32264.156	0,59
200	32265.154	32265.156	0,71
250	32266.154	32266.156	0,93
300	32267.154	32267.156	1,17

Hoekstukdeksel 90° Corner piece cover 90°			
B	Artikel nr. Product no.		Gewicht Weight
	AISI 304	AISI 316	
50	35261.144	35261.146	0,08
75	35262.144	35262.146	0,12
100	35263.144	35263.146	0,18
150	35264.144	35264.146	0,32
200	35265.144	35265.146	0,50
250	35266.144	35266.146	0,67
300	35267.144	35267.146	0,87

levering inclusief:  
8 slotbouten M6 x 12  
en flensmoeren  
supplied complete with:  
8 lock screws M6 x 12  
and flange nuts

# Tray H53



Det Norske Veritas (DNV) en Germanischer Lloyd (GL)

Aftakstuk  
Branch

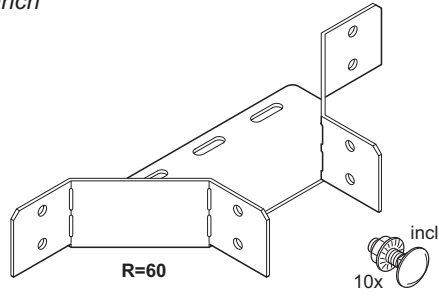

Driewegstuk (gelijkzijdig)  
Equal tee piece

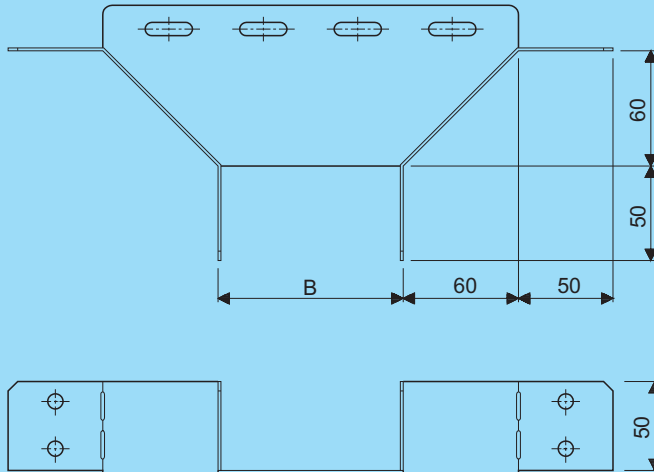
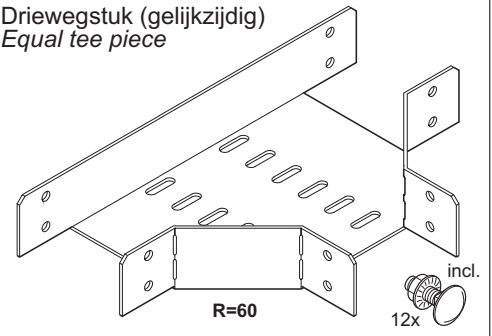

B	Artikel nr. Product no.		Gewicht Weight
	AISI 304	AISI 316	
50	32281.154	32281.156	0,31
75	32282.154	32282.156	0,32
100	32283.154	32283.156	0,34
150	32284.154	32284.156	0,37
200	32285.154	32285.156	0,41
250	32286.154	32286.156	0,44
300	32287.154	32287.156	0,47

B	Artikel nr. Product no.		Gewicht Weight
	AISI 304	AISI 316	
50	35281.144	35281.146	0,09
75	35282.144	35282.146	0,11
100	35283.144	35283.146	0,12
150	35284.144	35284.146	0,18
200	35285.144	35285.146	0,19
250	35286.144	35286.146	0,24
300	35287.144	35287.146	0,27

levering inclusief:  
10 slotbouten M6 x 12  
en flensmoeren

supplied complete with:  
10 lock screws M6 x 12  
and flange nuts

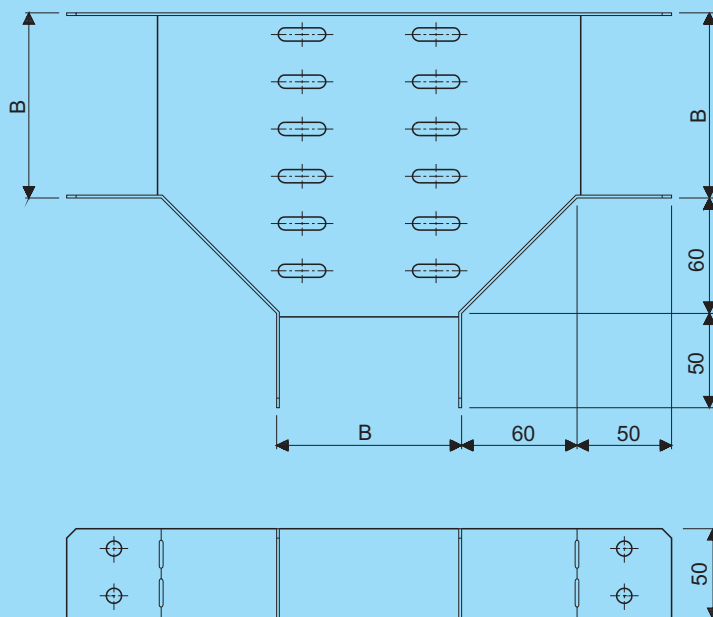

B	Artikel nr. Product no.		Gewicht Weight
	AISI 304	AISI 316	
50	32301.154	32301.156	0,44
75	32302.154	32302.156	0,48
100	32303.154	32303.156	0,58
150	32304.154	32304.156	0,76
200	32305.154	32305.156	0,98
250	32306.154	32306.156	1,25
300	32307.154	32307.156	1,55

B	Artikel nr. Product no.		Gewicht Weight
	AISI 304	AISI 316	
50	35301.144	35301.146	0,16
75	35302.144	35302.146	0,24
100	35303.144	35303.146	0,31
150	35304.144	35304.146	0,50
200	35305.144	35305.146	0,74
250	35306.144	35306.146	1,02
300	35307.144	35307.146	1,33

levering inclusief:  
12 slotbouten M6 x 12  
en flensmoeren

supplied complete with:  
12 lock screws M6 x 12  
and flange nuts

# Tray H53



Det Norske Veritas (DNV) en Germanischer Lloyd (GL)

Driewegstuk (ongelijkzijdig)  
Unequal tee piece (reducing)

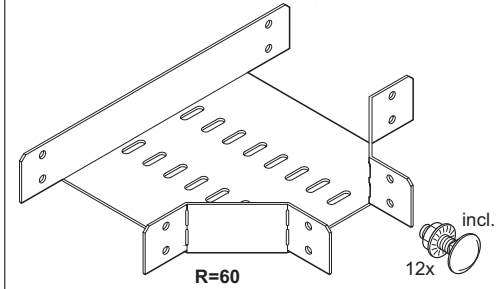

Tray

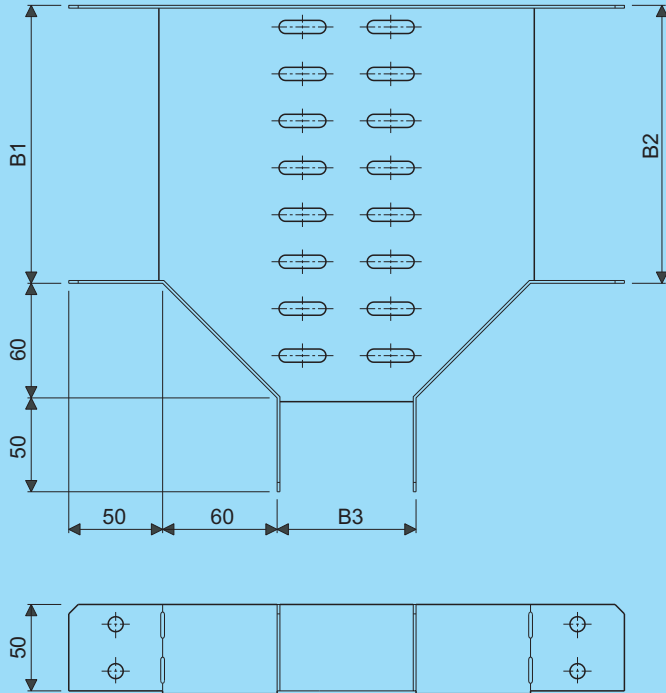

Driewegstuk (ongelijkzijdig) Unequal tee piece (reducing)				Driewegstukdeksel Unequal tee piece cover		
B1-B2-B3	Artikel nr. Product no.		Gewicht Weight	Artikel nr. Product no.		Gewicht Weight
	AISI 304	AISI 316		AISI 304	AISI 316	
75- 75- 50	32321.154	32321.156	0,47	35321.144	35321.146	0,20
100-100- 50	32322.154	32322.156	0,49	35322.144	35322.146	0,24
100-100- 75	32323.154	32323.156	0,54	35323.144	35323.146	0,27
150-150- 50	32324.154	32324.156	0,55	35324.144	35324.146	0,32
150-150- 75	32325.154	32325.156	0,61	35325.144	35325.146	0,37
150-150-100	32326.154	32326.156	0,62	35326.144	35326.146	0,42
200-200- 50	32327.154	32327.156	0,62	35327.144	35327.146	0,40
200-200- 75	32328.154	32328.156	0,68	35328.144	35328.146	0,46
200-200-100	32329.154	32329.156	0,74	35329.144	35329.146	0,52
200-200-150	32330.154	32330.156	0,86	35330.144	35330.146	0,63
250-250- 50	32331.154	32331.156	0,68	35331.144	35331.146	0,48
250-250- 75	32332.154	32332.156	0,75	35332.144	35332.146	0,55
250-250-100	32333.154	32333.156	0,82	35333.144	35333.146	0,62
250-250-150	32334.154	32334.156	0,96	35334.144	35334.146	0,75
250-250-200	32335.154	32335.156	1,11	35335.144	35335.146	0,88
300-300- 50	32336.154	32336.156	0,74	35336.144	35336.146	0,56
300-300- 75	32337.154	32337.156	0,82	35337.144	35337.146	0,64
300-300-100	32338.154	32338.156	0,90	35338.144	35338.146	0,72
300-300-150	32339.154	32339.156	1,06	35339.144	35339.146	0,87
300-300-200	32340.154	32340.156	1,23	35340.144	35340.146	1,02
300-300-250	32341.154	32341.156	1,39	35341.144	35341.146	1,18

levering inclusief:  
12 slotbouten M6 x 12  
en flensmoeren  
supplied complete with:  
12 lock screws M6 x 12  
and flange nuts



# Tray H53



Det Norske Veritas (DNV) en Germanischer Lloyd (GL)

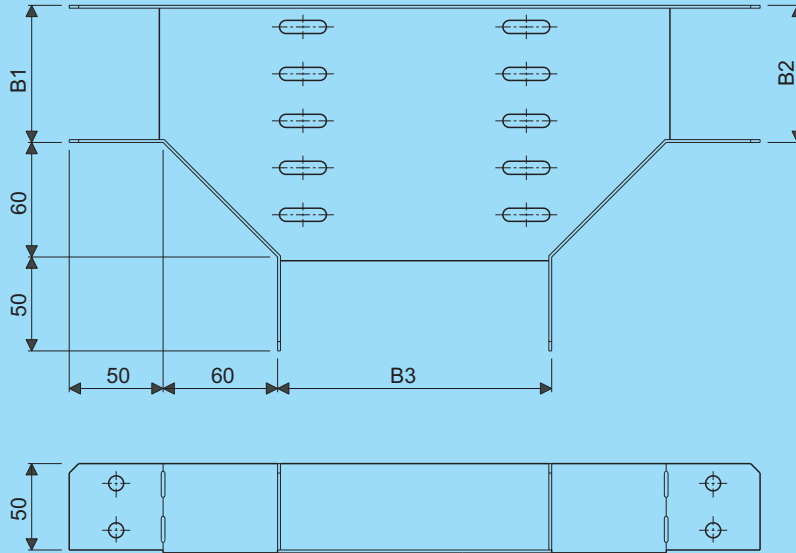
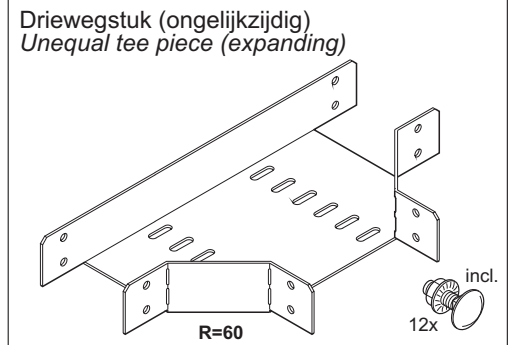

Tray

Driewegstuk (ongelijkzijdig) Unequal tee piece (expanding)				Driewegstukdeksel Unequal tee piece cover		
B1-B2-B3	Artikel nr. Product no.		Gewicht Weight	Artikel nr. Product no.		Gewicht Weight
	AISI 304	AISI 316		AISI 304	AISI 316	
50- 50- 75	32361.154	32361.156	0,47	35361.144	35361.146	0,19
50- 50-100	32362.154	32362.156	0,50	35362.144	35362.146	0,22
50- 50-150	32363.154	32363.156	0,56	35363.144	35363.146	0,27
50- 50-200	32364.154	32364.156	0,63	35364.144	35364.146	0,32
50- 50-250	32365.154	32365.156	0,69	35365.144	35365.146	0,38
50- 50-300	32366.154	32366.156	0,75	35366.144	35366.146	0,43
75- 75-100	32367.154	32367.156	0,54	35367.144	35367.146	0,27
75- 75-150	32368.154	32368.156	0,61	35368.144	35368.146	0,33
75- 75-200	32369.154	32369.156	0,69	35369.144	35369.146	0,39
75- 75-250	32370.154	32370.156	0,76	35370.144	35370.146	0,46
75- 75-300	32371.154	32371.156	0,83	35371.144	35371.146	0,52
100-100-150	32372.154	32372.156	0,66	35372.144	35372.146	0,39
100-100-200	32373.154	32373.156	0,74	35373.144	35373.146	0,46
100-100-250	32374.154	32374.156	0,83	35374.144	35374.146	0,54
100-100-300	32375.154	32375.156	0,91	35375.144	35375.146	0,61
150-150-200	32376.154	32376.156	0,86	35376.144	35376.146	0,60
150-150-250	32377.154	32377.156	0,97	35377.144	35377.146	0,70
150-150-300	32378.154	32378.156	1,07	35378.144	35378.146	0,79
200-200-250	32379.154	32379.156	1,11	35379.144	35379.146	0,86
200-200-300	32380.154	32380.156	1,23	35380.144	35380.146	0,97
250-250-300	32381.154	32381.156	1,39	35381.144	35381.146	1,15

levering inclusief:  
12 slotbouten M6 x 12  
en flensmoeren  
supplied complete with:  
12 lock screws M6 x 12  
and flange nuts

# Tray H53



Det Norske Veritas (DNV) en Germanischer Lloyd (GL)

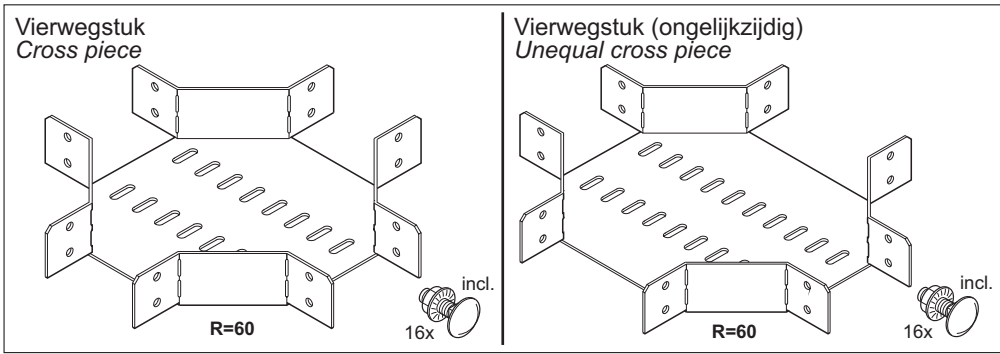

Tray

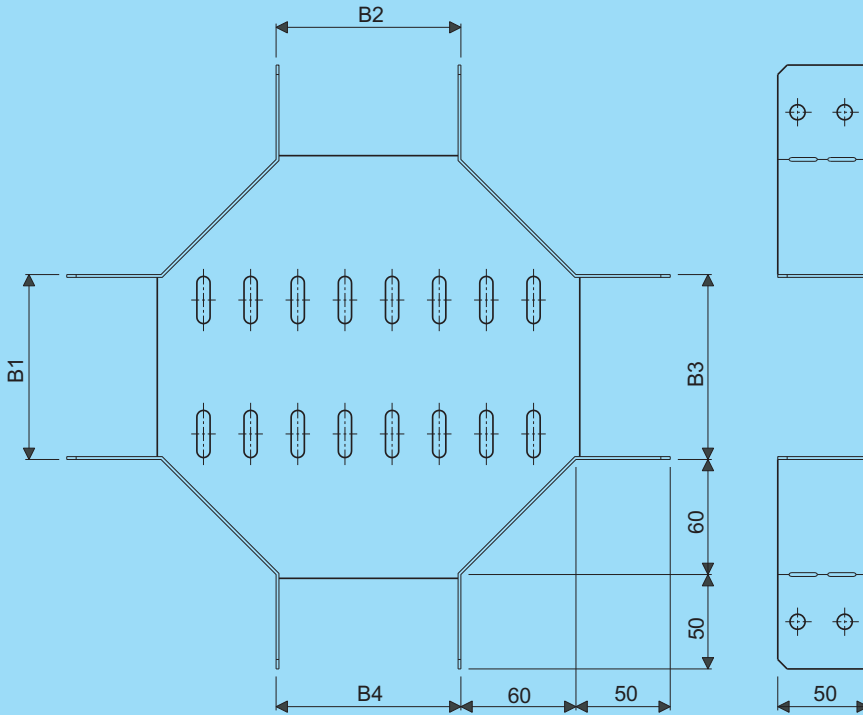

Vierwegstuk Cross piece			Vierwegstukdeksel Cross piece cover			
B1-B2-B3-B4	Artikel nr. Product no.		Gewicht Weight	Artikel nr. Product no.		Gewicht Weight
	AISI 304	AISI 316		AISI 304	AISI 316	
50- 50- 50- 50	32401.154	32401.156	0,56	35401.144	35401.146	0,22
75- 75- 75- 75	32402.154	32402.156	0,63	35402.144	35402.146	0,29
100-100-100-100	32403.154	32403.156	0,71	35403.144	35403.146	0,40
150-150-150-150	32404.154	32404.156	0,90	35404.144	35404.146	0,58
200-200-200-200	32405.154	32405.156	1,13	35405.144	35405.146	0,88
250-250-250-250	32406.154	32406.156	1,40	35406.144	35406.146	1,18
300-300-300-300	32407.154	32407.156	1,71	35407.144	35407.146	1,52
75- 50- 75- 50	32421.154	32421.156	0,59	35421.144	35421.146	0,26
100- 50-100- 50	32422.154	32422.156	0,63	35422.144	35422.146	0,30
100- 75-100- 75	32423.154	32423.156	0,67	35423.144	35423.146	0,35
150- 50-150- 50	32424.154	32424.156	0,68	35424.144	35424.146	0,38
150- 75-150- 75	32425.154	32425.156	0,74	35425.144	35425.146	0,44
150-100-150-100	32426.154	32426.156	0,79	35426.144	35426.146	0,50
200- 50-200- 50	32427.154	32427.156	0,74	35427.144	35427.146	0,46
200- 75-200- 75	32428.154	32428.156	0,81	35428.144	35428.146	0,53
200-100-200-100	32429.154	32429.156	0,87	35429.144	35429.146	0,60
200-150-200-150	32430.154	32430.156	1,00	35430.144	35430.146	0,74
250- 50-250- 50	32431.154	32431.156	0,80	35431.144	35431.146	0,54
250- 75-250- 75	32432.154	32432.156	0,88	35432.144	35432.146	0,62
250-100-250-100	32433.154	32433.156	0,95	35433.144	35433.146	0,70
250-150-250-150	32434.154	32434.156	1,10	35434.144	35434.146	0,86
250-200-250-200	32435.154	32435.156	1,25	35435.144	35435.146	1,02
300- 50-300- 50	32436.154	32436.156	0,87	35436.144	35436.146	0,62
300- 75-300- 75	32437.154	32437.156	0,95	35437.144	35437.146	0,71
300-100-300-100	32438.154	32438.156	1,03	35438.144	35438.146	0,80
300-150-300-150	32439.154	32439.156	1,20	35439.144	35439.146	0,98
300-200-300-200	32440.154	32440.156	1,37	35440.144	35440.146	1,16
300-250-300-250	32441.154	32441.156	1,54	35441.144	35441.146	1,34

levering inclusief:  
16 slotbouten M6 x 12  
en flensmoeren

supplied complete with:  
16 lock screws M6 x 12  
and flange nuts

# Tray H53



Det Norske Veritas (DNV) en Germanischer Lloyd (GL)

## Stijgstuk 45° Vertical inner bend 45°

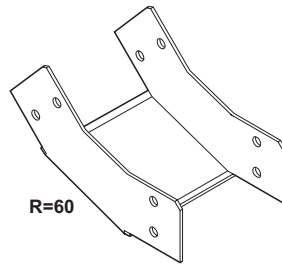

R=60



## Stijgstuk 90° Vertical inner bend 90°

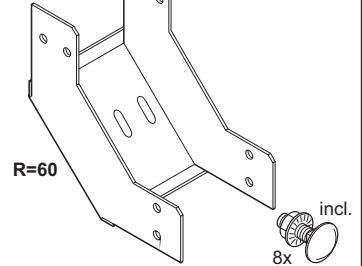

R=60

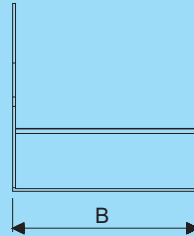
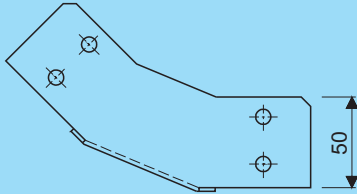

Stijgstuk 45° Vertical inner bend 45°			
B	Artikel nr. Product no.		Gewicht Weight
	AISI 304	AISI 316	
50	32461.154	32461.156	0,23
75	32462.154	32462.156	0,24
100	32463.154	32463.156	0,26
150	32464.154	32464.156	0,29
200	32465.154	32465.156	0,33
250	32466.154	32466.156	0,37
300	32467.154	32467.156	0,40

Stijgstukdeksel 45° Vertical inner bend cover 45°			
B	Artikel nr. Product no.		Gewicht Weight
	AISI 304	AISI 316	
50	35461.144	35461.146	0,04
75	35462.144	35462.146	0,05
100	35463.144	35463.146	0,07
150	35464.144	35464.146	0,10
200	35465.144	35465.146	0,13
250	35466.144	35466.146	0,15
300	35467.144	35467.146	0,19

levering inclusief:  
8 slotbouten M6 x 12  
en flensmoeren

supplied complete with:  
8 lock screws M6 x 12  
and flange nuts

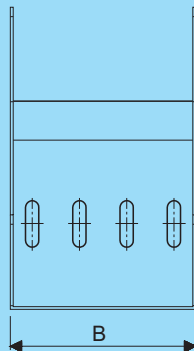
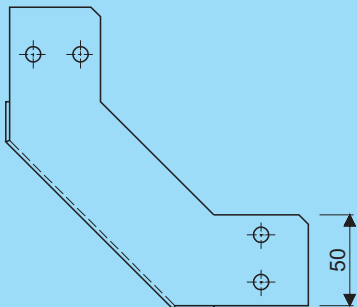

Stijgstuk 90° Vertical inner bend 90°			
B	Artikel nr. Product no.		Gewicht Weight
	AISI 304	AISI 316	
50	32481.154	32481.156	0,29
75	32482.154	32482.156	0,33
100	32483.154	32483.156	0,36
150	32484.154	32484.156	0,42
200	32485.154	32485.156	0,48
250	32486.154	32486.156	0,55
300	32487.154	32487.156	0,61

Stijgstukdeksel 90° Vertical inner bend cover 90°			
B	Artikel nr. Product no.		Gewicht Weight
	AISI 304	AISI 316	
50	35481.144	35481.146	0,06
75	35482.144	35482.146	0,08
100	35483.144	35483.146	0,10
150	35484.144	35484.146	0,15
200	35485.144	35485.146	0,20
250	35486.144	35486.146	0,23
300	35487.144	35487.146	0,29

levering inclusief:  
8 slotbouten M6 x 12  
en flensmoeren

supplied complete with:  
8 lock screws M6 x 12  
and flange nuts

Vervalstuk 45°  
Vertical outer bend 45°

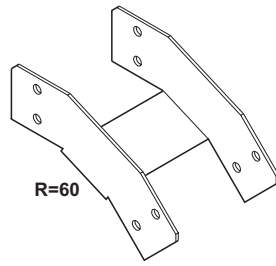

incl.  
8x

Vervalstuk 90°  
Vertical outer bend 90°

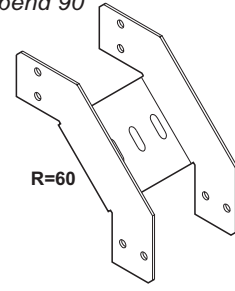

incl.  
8x

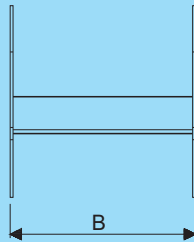
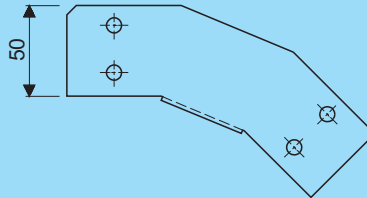

Vervalstuk 45° Vertical outer bend 45°			
B	Artikel nr. Product no.		Gewicht Weight
	AISI 304	AISI 316	
50	32501.154	32501.156	0,22
75	32502.154	32502.156	0,22
100	32503.154	32503.156	0,23
150	32504.154	32504.156	0,25
200	32505.154	32505.156	0,27
250	32506.154	32506.156	0,29
300	32507.154	32507.156	0,31

Vervalstukdeksel 45° Vertical outer bend cover 45°			
B	Artikel nr. Product no.		Gewicht Weight
	AISI 304	AISI 316	
50	35501.144	35501.146	0,06
75	35502.144	35502.146	0,08
100	35503.144	35503.146	0,10
150	35504.144	35504.146	0,15
200	35505.144	35505.146	0,19
250	35506.144	35506.146	0,23
300	35507.144	35507.146	0,29

levering inclusief:  
8 slotbouten M6 x 12  
en flensmoeren

supplied complete with:  
8 lock screws M6 x 12  
and flange nuts

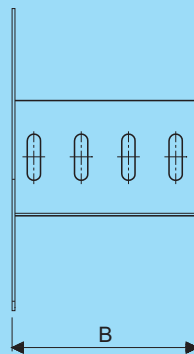
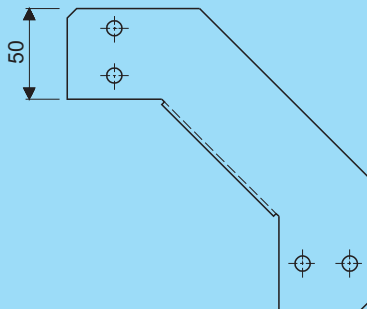

Vervalstuk 90° Vertical outer bend 90°			
B	Artikel nr. Product no.		Gewicht Weight
	AISI 304	AISI 316	
50	32521.154	32521.156	0,27
75	32522.154	32522.156	0,28
100	32523.154	32523.156	0,30
150	32524.154	32524.156	0,33
200	32525.154	32525.156	0,36
250	32526.154	32526.156	0,39
300	32527.154	32527.156	0,42

Vervalstukdeksel 90° Vertical outer bend cover 90°			
B	Artikel nr. Product no.		Gewicht Weight
	AISI 304	AISI 316	
50	35521.144	35521.146	0,10
75	35522.144	35522.146	0,14
100	35523.144	35523.146	0,22
150	35524.144	35524.146	0,26
200	35525.144	35525.146	0,33
250	35526.144	35526.146	0,40
300	35527.144	35527.146	0,49

levering inclusief:  
8 slotbouten M6 x 12  
en flensmoeren

supplied complete with:  
8 lock screws M6 x 12  
and flange nuts

# Tray H78R

Kabelkanaal H78R  
Cable duct H78R

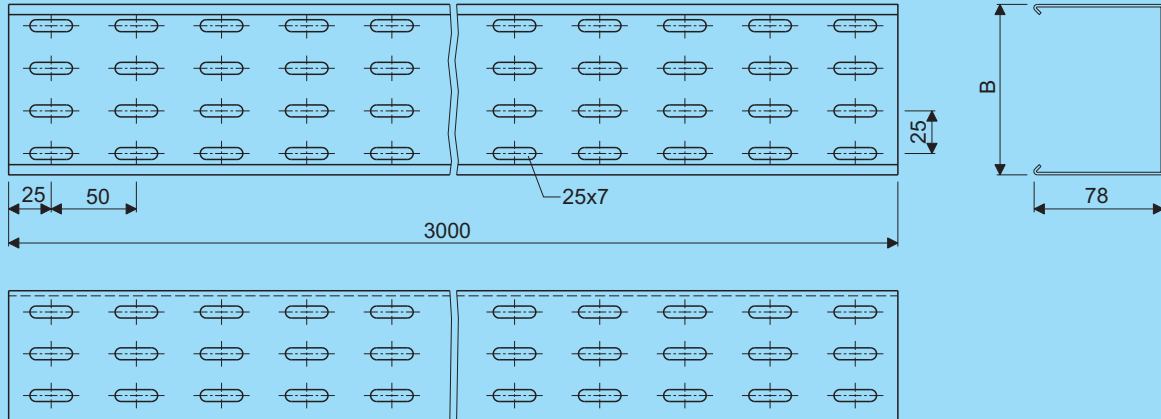
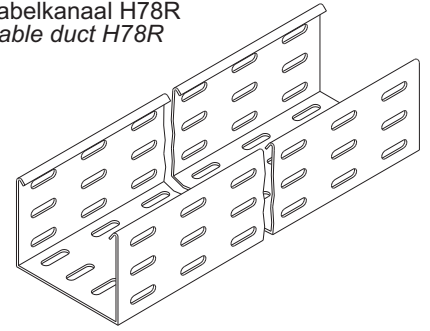

Kabelkanaal H78R Cable duct H78R				Kabelkanaaldeksel Cable duct cover			
B	Artikel nr. Product no.		Gewicht Weight	Artikel nr. Product no.		Gewicht Weight	
	AISI 304	AISI 316		AISI 304	AISI 316		
75	33082.154	33082.156	4,76	35042.144	35042.146	2,30	
100	33083.154	33083.156	5,25	35043.144	35043.146	2,90	
150	33084.154	33084.156	6,24	35044.144	35044.146	4,10	
200	33085.154	33085.156	7,22	35045.144	35045.146	5,30	
250	33086.154	33086.156	8,20	35046.144	35046.146	6,50	
300	33087.154	33087.156	9,19	35047.144	35047.146	7,70	

sleufperforatie in de lengterichting in verband met **EMC**

perforation slots lengthways in view of **EMC**

bestel de benodigde koppelplaten apart, zij worden niet geleverd bij de kanalen

order splice plates as separate items, they are not supplied with the cable ducts

Dekselveer  
Cover spring

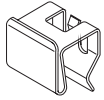

Dekselklem  
Cover clamp

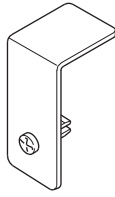

Sluitband met tape  
Fastener with tape

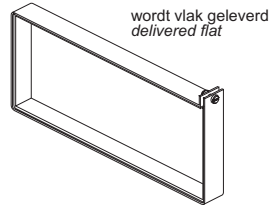

min. 1 st. per meter  
min. 1 pc. per meter



Sluitband zonder tape  
Fastener without tape

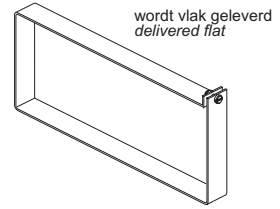

min. 1 st. per meter  
min. 1 pc. per meter

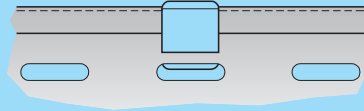
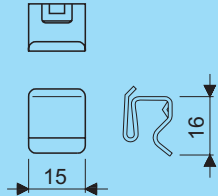

montage-toepassing  
mounting application

Dekselveer Cover spring	
Artikel nr. Product no.	Gewicht Weight
99983.209	0,002

bestel de benodigde deksel-  
veren apart, zij worden niet  
geleverd bij de deksels

kindly order cover springs as  
a separate item, they are  
not supplied with the covers

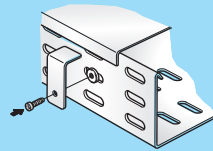
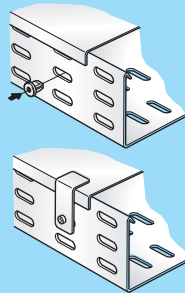
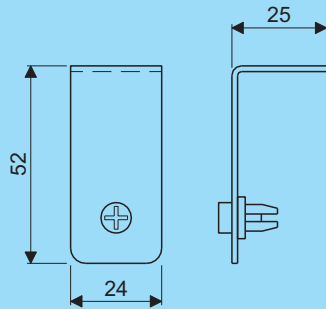

montage-toepassing  
mounting application

levering inclusief  
nylon plaatmoer en  
bolkopschroef

supplied complete  
with plate nut and  
roundhead screw

Dekselklem Cover clamp		
Artikel nr. Product no.		Gewicht Weight
AISI 304	AISI 316	
99984.204	99984.206	0,02

bestel de benodigde deksel-  
klemmen apart, zij worden  
niet geleverd bij de deksels

kindly order cover clamps as  
a separate item, they are  
not supplied with the covers

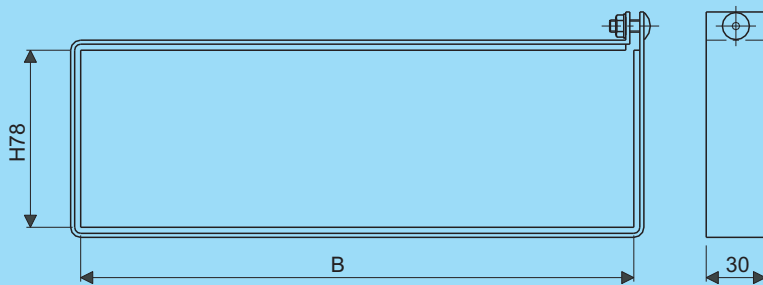

Sluitband met tape Fastener with tape			
B	Artikel nr. Product no.		Gewicht Weight
	AISI 304	AISI 316	
75	33602.154	33602.156	0,09
100	33603.154	33603.156	0,11
150	33604.154	33604.156	0,13
200	33605.154	33605.156	0,15
250	33606.154	33606.156	0,18
300	33607.154	33607.156	0,20

levering inclusief: supplied complete with:  
1 slotbout M6 x 12 en flensmoer 1 lock screw M6 x 12 and flange nut

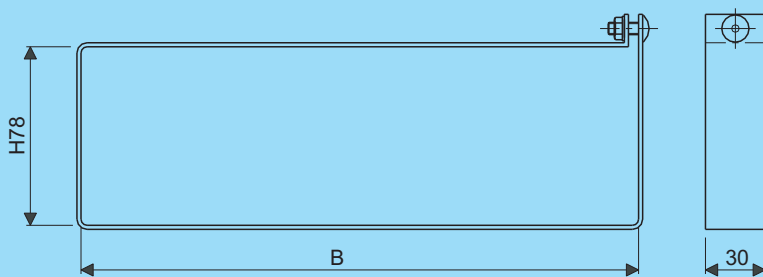

Sluitband zonder tape Fastener without tape			
B	Artikel nr. Product no.		Gewicht Weight
	AISI 304	AISI 316	
75	33612.154	33612.156	0,09
100	33613.154	33613.156	0,11
150	33614.154	33614.156	0,13
200	33615.154	33615.156	0,15
250	33616.154	33616.156	0,18
300	33617.154	33617.156	0,20

levering inclusief: supplied complete with:  
1 slotbout M6 x 12 en flensmoer 1 lock screw M6 x 12 and flange nut

Koppelplaat  
Splice plate

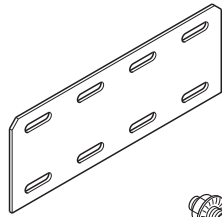

incl.  
4x

Scharnierende koppelplaat  
Hinged splice plate

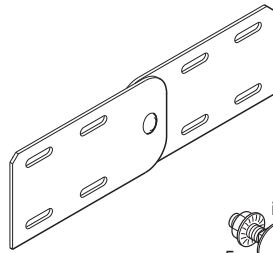

incl.  
5x

Scheidingsschot  
Separation strip

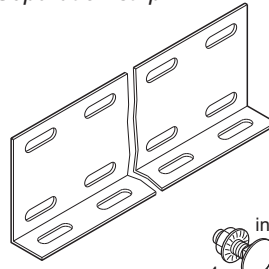

incl.  
4x

Eindschot/Verloopkoppelplaat  
Endplate/Reducer splice plate

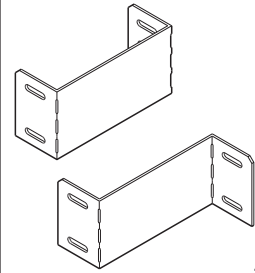

incl.  
4x

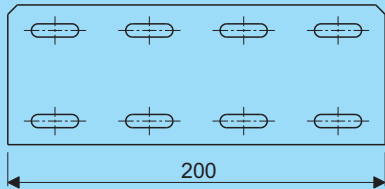

levering inclusief:  
4 slotbouten M6 x12  
en flensmoeren  
*supplied complete with:  
4 lock screws M6 x 12  
and flange nuts*

Koppelplaat Splice plate		
Artikel nr. Product no.		Gewicht Weight
AISI 304	AISI 316	
33132.154	33132.156	0,14

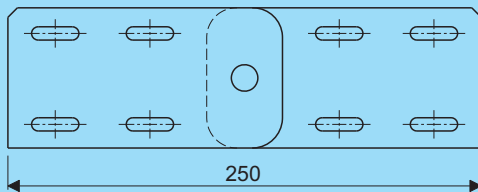

Scharnierende koppelplaat Hinged splice plate		
Artikel nr. Product no.		Gewicht Weight
AISI 304	AISI 316	
33151.154	33151.156	0,27

levering inclusief:  
5 slotbouten M6 x12  
en flensmoeren  
*supplied complete with:  
5 lock screws M6 x 12  
and flange nuts*

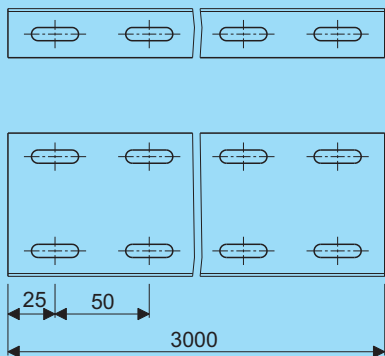

levering inclusief:  
4 slotbouten M6 x12  
en flensmoeren  
*supplied complete with:  
4 lock screws M6 x 12  
and flange nuts*

Scheidingsschot Separation strip		
Artikel nr. Product no.		Gewicht Weight
AISI 304	AISI 316	
98725.154	98725.156	2,00

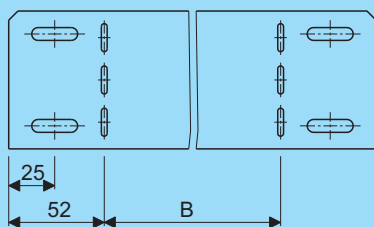

Eindschot/Verloopkoppelplaat Endplate/Reducer splice plate			
B	Artikel nr. Product no.		Gewicht Weight
	AISI 304	AISI 316	
25	33170.154	33170.156	0,11
50	33171.154	33171.156	0,12
75	33172.154	33172.156	0,13
100	33173.154	33173.156	0,14
150	33174.154	33174.156	0,17
200	33175.154	33175.156	0,20
250	33176.154	33176.156	0,23
300	33177.154	33177.156	0,26

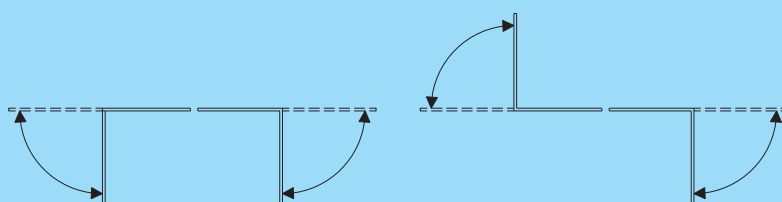

levering inclusief:  
4 slotbouten M6 x12  
en flensmoeren  
*supplied complete with:  
4 lock screws M6 x 12  
and flange nuts*

# Tray H78

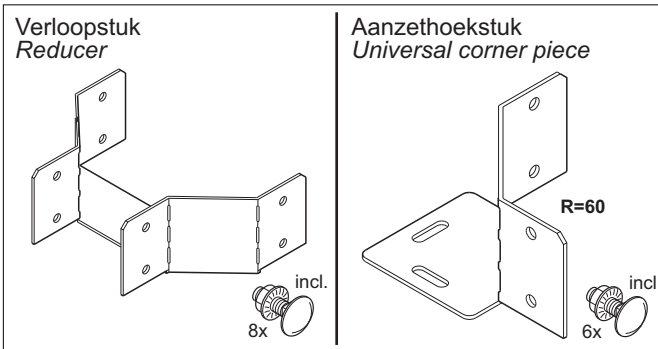

Tray

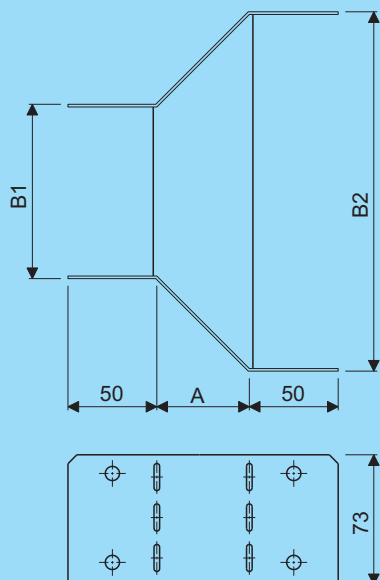

Verloopstuk Reducer					Verloopstukdeksel Reducer cover		
A	B1-B2	Artikel nr. Product no.		Gewicht Weight	Artikel nr. Product no.		Gewicht Weight
		AISI 304	AISI 316		AISI 304	AISI 316	
47	75-100	33194.154	33194.156	0,28	35194.144	35194.146	0,06
38	75-150	33195.154	33195.156	0,28	35195.144	35195.146	0,07
63	75-200	33196.154	33196.156	0,36	35196.144	35196.146	0,11
44	100-150	33197.154	33197.156	0,29	35197.144	35197.146	0,08
50	100-200	33198.154	33198.156	0,33	35198.144	35198.146	0,11
75	100-250	33199.154	33199.156	0,42	35199.144	35199.146	0,16
44	150-200	33200.154	33200.156	0,31	35200.144	35200.146	0,11
50	150-250	33201.154	33201.156	0,35	35201.144	35201.146	0,14
75	150-300	33202.154	33202.156	0,45	35202.144	35202.146	0,20
44	200-250	33203.154	33203.156	0,33	35203.144	35203.146	0,14
50	200-300	33204.154	33204.156	0,37	35204.144	35204.146	0,17
44	250-300	33206.154	33206.156	0,34	35206.144	35206.146	0,17

levering inclusief:  
8 slotbouten M6 x12  
en flensmoeren

supplied complete with:  
8 lock screws M6 x 12  
and flange nuts

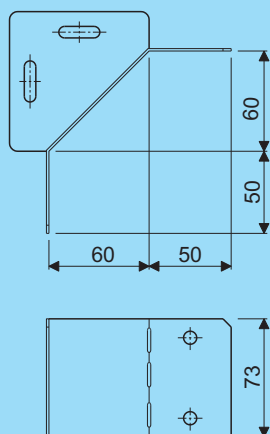

Aanzethoekstuk Universal corner piece		
Artikel nr. Product no.		Gewicht Weight
AISI 304	AISI 316	
33221.154	33221.156	0,22

levering inclusief:  
6 slotbouten M6 x12  
en flensmoeren

supplied complete with:  
6 lock screws M6 x 12  
and flange nuts



# Tray H78

Hoekstuk 45°  
Corner piece 45°

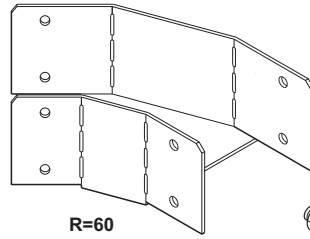

R=60



Hoekstuk 90°  
Corner piece 90°

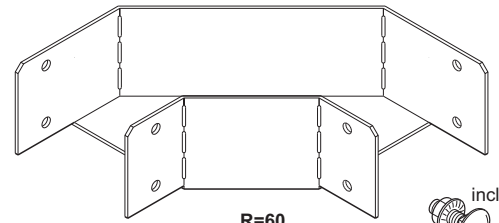

R=60

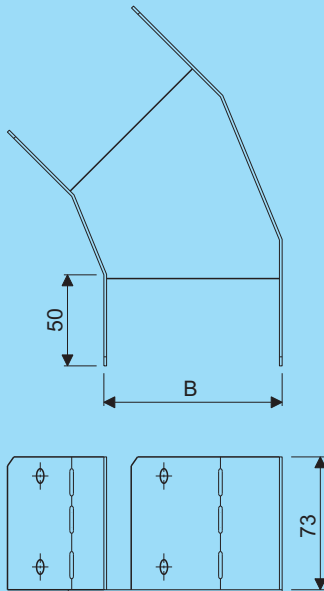

Hoekstuk 45° Corner piece 45°			Hoekstukdeksel 45° Corner piece cover 45°			
B	Artikel nr. Product no.		Gewicht Weight	Artikel nr. Product no.		Gewicht Weight
	AISI 304	AISI 316		AISI 304	AISI 316	
75	33242.154	33242.156	0,29	35242.144	35242.146	0,07
100	33243.154	33243.156	0,32	35243.144	35243.146	0,10
150	33244.154	33244.156	0,39	35244.144	35244.146	0,17
200	33245.154	33245.156	0,47	35245.144	35245.146	0,26
250	33246.154	33246.156	0,56	35246.144	35246.146	0,36
300	33247.154	33247.156	0,67	35247.144	35247.146	0,48

levering inclusief:  
8 slotbouten M6 x 12  
en flensmoeren

supplied complete with:  
8 lock screws M6 x 12  
and flange nuts

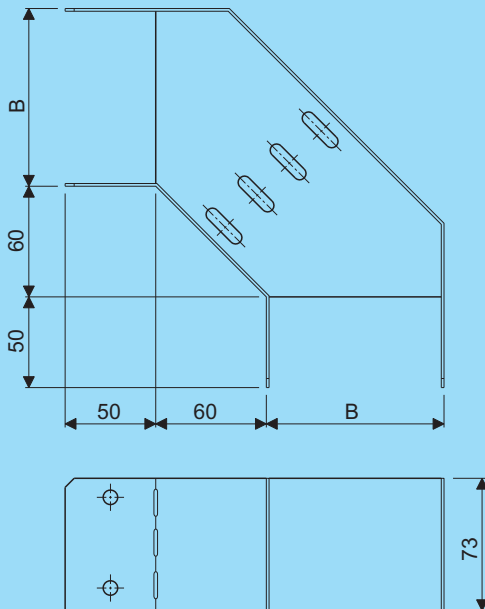

Hoekstuk 90° Corner piece 90°			Hoekstukdeksel 90° Corner piece cover 90°			
B	Artikel nr. Product no.		Gewicht Weight	Artikel nr. Product no.		Gewicht Weight
	AISI 304	AISI 316		AISI 304	AISI 316	
75	33262.154	33262.156	0,45	35262.144	35262.146	0,12
100	33263.154	33263.156	0,52	35263.144	35263.146	0,18
150	33264.154	33264.156	0,68	35264.144	35264.146	0,32
200	33265.154	33265.156	0,82	35265.144	35265.146	0,50
250	33266.154	33266.156	1,10	35266.144	35266.146	0,67
300	33267.154	33267.156	1,36	35267.144	35267.146	0,87

levering inclusief:  
8 slotbouten M6 x 12  
en flensmoeren  
supplied complete with:  
8 lock screws M6 x 12  
and flange nuts

# Tray H78

Aftakstuk  
Branch

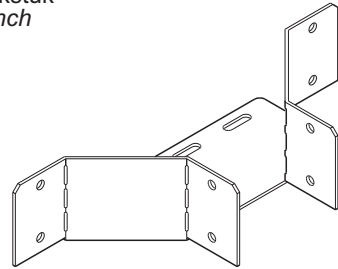

R=60

incl.  
10x

Driewegstuk (gelijkzijdig)  
Equal tee piece

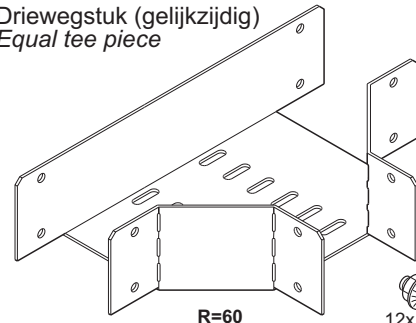

R=60

incl.  
12x

Tray

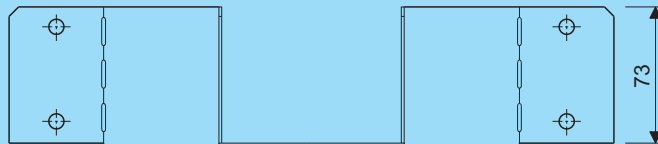
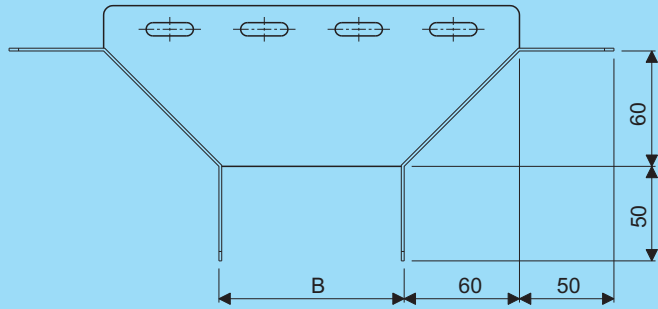

Aftakstuk Branch			
B	Artikel nr. Product no.		Gewicht Weight
	AISI 304	AISI 316	
75	33282.154	33282.156	0,41
100	33283.154	33283.156	0,47
150	33284.154	33284.156	0,61
200	33285.154	33285.156	0,80
250	33286.154	33286.156	1,02
300	33287.154	33287.156	1,28

Aftakstukdeksel Branch cover			
B	Artikel nr. Product no.		Gewicht Weight
	AISI 304	AISI 316	
75	35282.144	35282.146	0,11
100	35283.144	35283.146	0,12
150	35284.144	35284.146	0,18
200	35285.144	35285.146	0,19
250	35286.144	35286.146	0,24
300	35287.144	35287.146	0,27

levering inclusief:  
10 slotbouten M6 x 12  
en flensmoeren

supplied complete with:  
10 lock screws M6 x 12  
and flange nuts

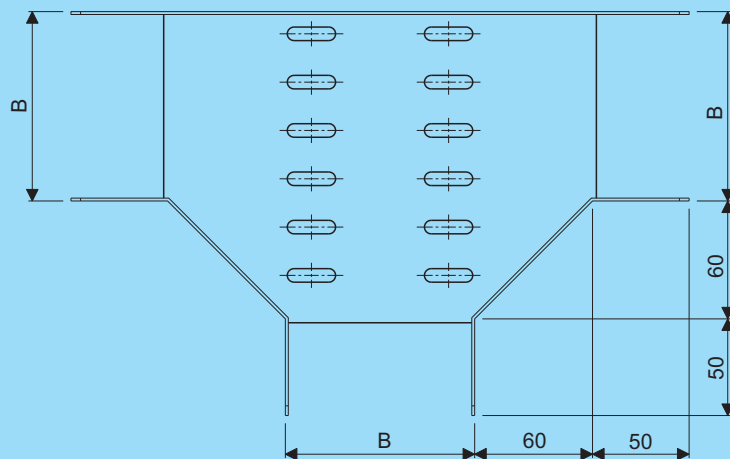

Driewegstuk (gelijkzijdig) Equal tee piece			
B	Artikel nr. Product no.		Gewicht Weight
	AISI 304	AISI 316	
75	33302.154	33302.156	0,64
100	33303.154	33303.156	0,73
150	33304.154	33304.156	0,92
200	33305.154	33305.156	1,16
250	33306.154	33306.156	1,43
300	33307.154	33307.156	1,74

Driewegstukdeksel (gelijkzijdig) Equal tee piece cover			
B	Artikel nr. Product no.		Gewicht Weight
	AISI 304	AISI 316	
75	35302.144	35302.146	0,24
100	35303.144	35303.146	0,31
150	35304.144	35304.146	0,50
200	35305.144	35305.146	0,74
250	35306.144	35306.146	1,02
300	35307.144	35307.146	1,33

levering inclusief:  
12 slotbouten M6 x 12  
en flensmoeren

supplied complete with:  
12 lock screws M6 x 12  
and flange nuts

# Tray H78

Driewegstuk (ongelijkzijdig)  
Unequal tee piece (reducing)

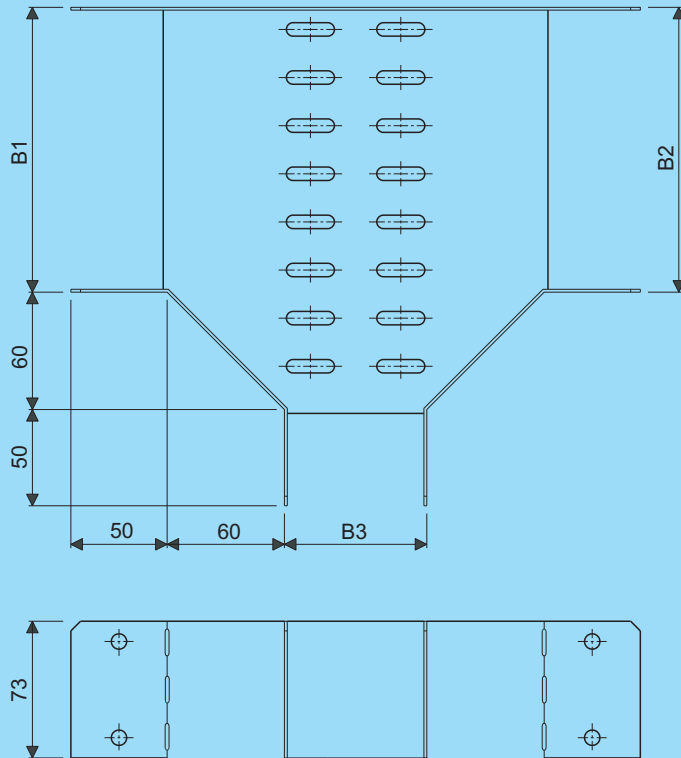
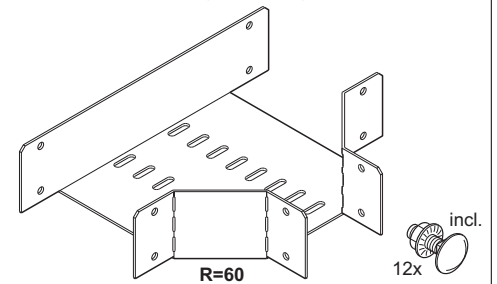

levering inclusief:  
12 slotbouten M6 x 12  
en flensmoeren  
supplied complete with:  
12 lock screws M6 x 12  
and flange nuts

Driewegstuk (ongelijkzijdig) Unequal tee piece (reducing)				Driewegstukdeksel Unequal tee piece cover		
B1-B2-B3	Artikel nr. Product no.		Gewicht Weight	Artikel nr. Product no.		Gewicht Weight
	AISI 304	AISI 316		AISI 304	AISI 316	
100-100- 75	33323.154	33323.156	0,68	35323.144	35323.146	0,27
150-150- 75	33325.154	33325.156	0,75	35325.144	35325.146	0,32
150-150-100	33326.154	33326.156	0,81	35326.144	35326.146	0,37
200-200- 75	33328.154	33328.156	0,82	35328.144	35328.146	0,42
200-200-100	33329.154	33329.156	0,89	35329.144	35329.146	0,40
200-200-150	33330.154	33330.156	1,02	35330.144	35330.146	0,46
250-250- 75	33332.154	33332.156	0,89	35332.144	35332.146	0,52
250-250-100	33333.154	33333.156	0,92	35333.144	35333.146	0,63
250-250-150	33334.154	33334.156	1,12	35334.144	35334.146	0,48
250-250-200	33335.154	33335.156	1,28	35335.144	35335.146	0,55
300-300- 75	33337.154	33337.156	0,96	35337.144	35337.146	0,62
300-300-100	33338.154	33338.156	1,05	35338.144	35338.146	0,75
300-300-150	33339.154	33339.156	1,22	35339.144	35339.146	0,88
300-300-200	33340.154	33340.156	1,40	35340.144	35340.146	0,56
300-300-250	33341.154	33341.156	1,57	35341.144	35341.146	0,64

# Tray H78

Driewegstuk (ongelijkzijdig)  
Unequal tee piece (expanding)

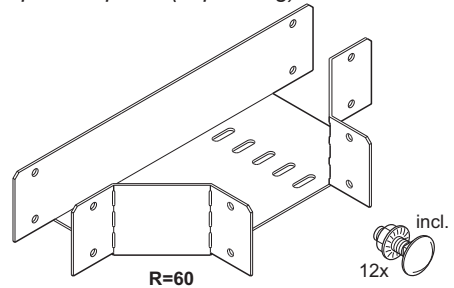

Tray

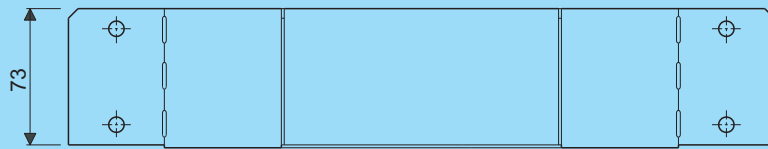
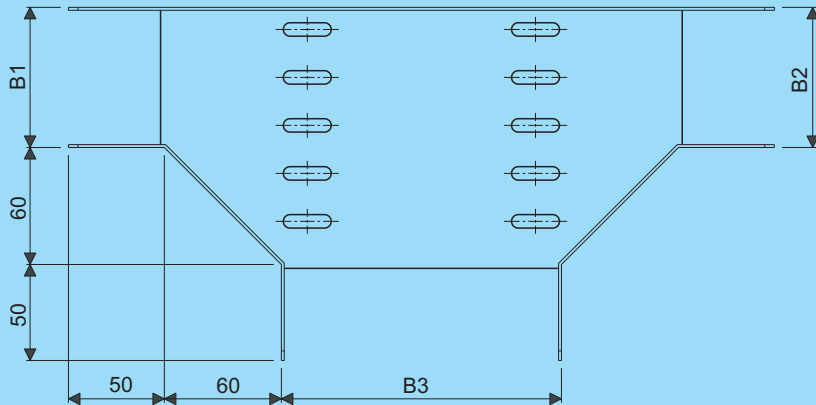

levering inclusief:  
12 slotbouten M6 x 12  
en flensmoeren  
supplied complete with:  
12 lock screws M6 x 12  
and flange nuts

Driewegstuk (ongelijkzijdig) Unequal tee piece (expanding)				Driewegstukdeksel Unequal tee piece cover			
B1-B2-B3	Artikel nr. Product no.		Gewicht Weight	Artikel nr. Product no.		Gewicht Weight	
	AISI 304	AISI 316		AISI 304	AISI 316		
75- 75-100	33367.154	33367.156	0,69	35367.144	35367.146	0,27	
75- 75-150	33368.154	33368.156	0,77	35368.144	35368.146	0,33	
75- 75-200	33369.154	33369.156	0,85	35369.144	35369.146	0,39	
75- 75-250	33370.154	33370.156	0,94	35370.144	35370.146	0,46	
75- 75-300	33371.154	33371.156	1,02	35371.144	35371.146	0,52	
100-100-150	33372.154	33372.156	0,82	35372.144	35372.146	0,39	
100-100-200	33373.154	33373.156	0,91	35373.144	35373.146	0,46	
100-100-250	33374.154	33374.156	1,01	35374.144	35374.146	0,54	
100-100-300	33375.154	33375.156	1,10	35375.144	35375.146	0,61	
150-150-200	33376.154	33376.156	1,04	35376.144	35376.146	0,60	
150-150-250	33377.154	33377.156	1,15	35377.144	35377.146	0,70	
150-150-300	33378.154	33378.156	1,26	35378.144	35378.146	0,79	
200-200-250	33379.154	33379.156	1,29	35379.144	35379.146	0,86	
200-200-300	33380.154	33380.156	1,42	35380.144	35380.146	0,97	
250-250-300	33381.154	33381.156	1,58	35381.144	35381.146	1,15	

# Tray H78

Vierwegstuk  
Cross piece

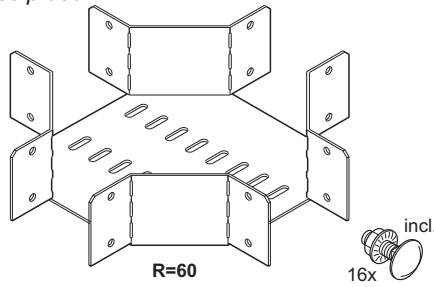

Vierwegstuk (ongelijkzijdig)  
Unequal cross piece

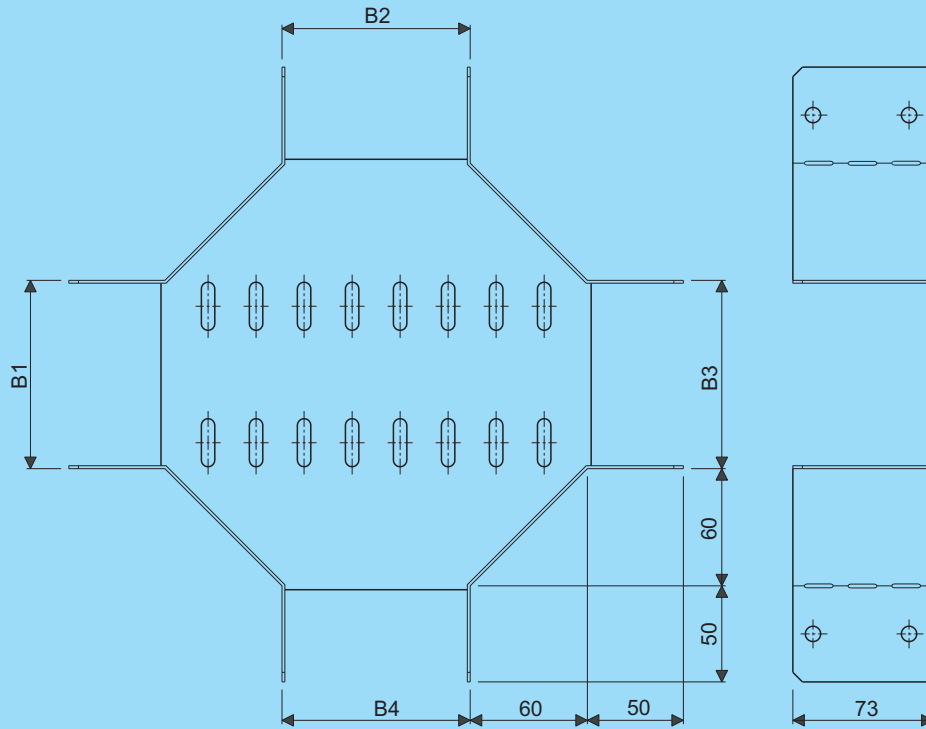
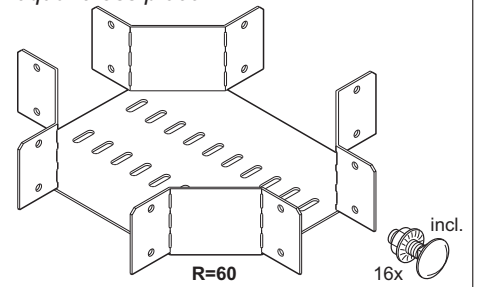

Vierwegstuk Cross piece			Vierwegstukdeksel Cross piece cover			
B1-B2-B3-B4	Artikel nr. Product no.		Gewicht Weight	Artikel nr. Product no.		Gewicht Weight
	AISI 304	AISI 316		AISI 304	AISI 316	
75- 75- 75- 75	33402.154	33402.156	0,85	35402.144	35402.146	0,22
100-100-100-100	33403.154	33403.156	0,93	35403.144	35403.146	0,29
150-150-150-150	33404.154	33404.156	1,12	35404.144	35404.146	0,40
200-200-200-200	33405.154	33405.156	1,35	35405.144	35405.146	0,58
250-250-250-250	33406.154	33406.156	1,62	35406.144	35406.146	0,88
300-300-300-300	33407.154	33407.156	1,93	35407.144	35407.146	1,18
100- 75-100- 75	33423.154	33423.156	0,89	35423.144	35423.146	1,52
150- 75-150- 75	33425.154	33425.156	0,96	35425.144	35425.146	0,26
150-100-150-100	33426.154	33426.156	1,01	35426.144	35426.146	0,30
200- 75-200- 75	33428.154	33428.156	1,03	35428.144	35428.146	0,35
200-100-200-100	33429.154	33429.156	1,09	35429.144	35429.146	0,38
200-150-200-150	33430.154	33430.156	1,22	35430.144	35430.146	0,44
250- 75-250- 75	33432.154	33432.156	1,10	35432.144	35432.146	0,50
250-100-250-100	33433.154	33433.156	1,17	35433.144	35433.146	0,46
250-150-250-150	33434.154	33434.156	1,32	35434.144	35434.146	0,53
250-200-250-200	33435.154	33435.156	1,47	35435.144	35435.146	0,60
300- 75-300- 75	33437.154	33437.156	1,17	35437.144	35437.146	0,74
300-100-300-100	33438.154	33438.156	1,25	35438.144	35438.146	0,54
300-150-300-150	33439.154	33439.156	1,42	35439.144	35439.146	0,62
300-200-300-200	33440.154	33440.156	1,59	35440.144	35440.146	0,70
300-250-300-250	33441.154	33441.156	1,76	35441.144	35441.146	0,86

levering inclusief:  
16 slotbouten M6 x 12  
en flensmoeren  
supplied complete with:  
16 lock screws M6 x 12  
and flange nuts

# Tray H78

Stijgstuk 45°  
Vertical inner bend 45°

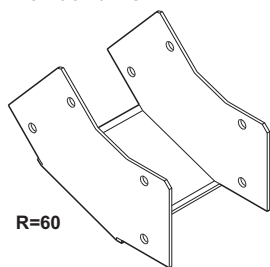

R=60

incl.  
8x

Stijgstuk 90°  
Vertical inner bend 90°

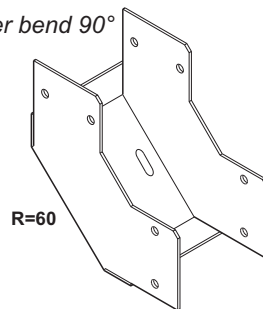

R=60

incl.  
8x

Tray

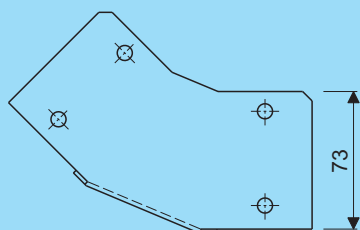

73

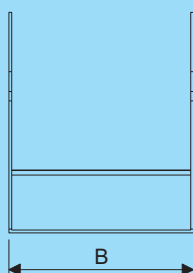

B

Stijgstuk 45°  
Vertical inner bend 45°

B	Artikel nr. Product no.		Gewicht Weight
	AISI 304	AISI 316	
75	33462.154	33462.156	0,32
100	33463.154	33463.156	0,34
150	33464.154	33464.156	0,38
200	33465.154	33465.156	0,43
250	33466.154	33466.156	0,47
300	33467.154	33467.156	0,51

Stijgstukdeksel 45°  
Vertical inner bend cover 45°

B	Artikel nr. Product no.		Gewicht Weight
	AISI 304	AISI 316	
75	35462.144	35462.146	0,05
100	35463.144	35463.146	0,07
150	35464.144	35464.146	0,10
200	35465.144	35465.146	0,13
250	35466.144	35466.146	0,15
300	35467.144	35467.146	0,19

levering inclusief:  
8 slotbouten M6 x 12  
en flensmoeren

supplied complete with:  
8 lock screws M6 x 12  
and flange nuts

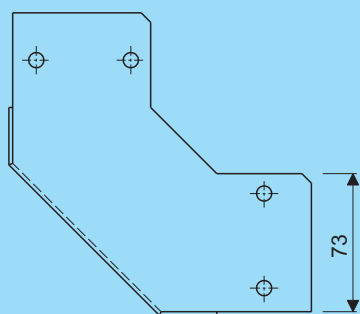

73

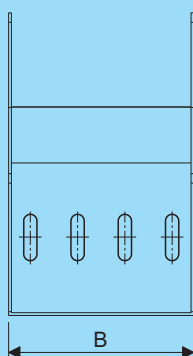

B

Stijgstuk 90°  
Vertical inner bend 90°

B	Artikel nr. Product no.		Gewicht Weight
	AISI 304	AISI 316	
75	33482.154	33482.156	0,45
100	33483.154	33483.156	0,49
150	33484.154	33484.156	0,57
200	33485.154	33485.156	0,65
250	33486.154	33486.156	0,73
300	33487.154	33487.156	0,81

Stijgstukdeksel 90°  
Vertical inner bend cover 90°

B	Artikel nr. Product no.		Gewicht Weight
	AISI 304	AISI 316	
75	35482.144	35482.146	0,08
100	35483.144	35483.146	0,10
150	35484.144	35484.146	0,15
200	35485.144	35485.146	0,20
250	35486.144	35486.146	0,23
300	35487.144	35487.146	0,29

levering inclusief:  
8 slotbouten M6 x 12  
en flensmoeren

supplied complete with:  
8 lock screws M6 x 12  
and flange nuts

# Tray H78

Vervalstuk 45°  
Vertical outer bend 45°

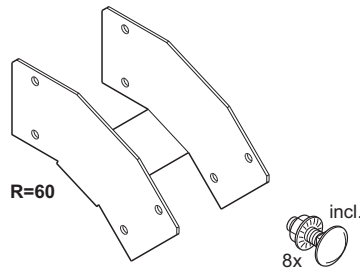

Vervalstuk 90°  
Vertical outer bend 90°

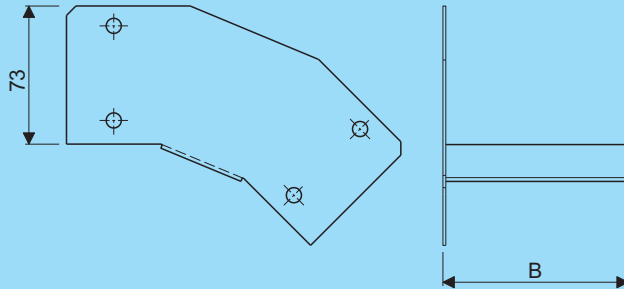
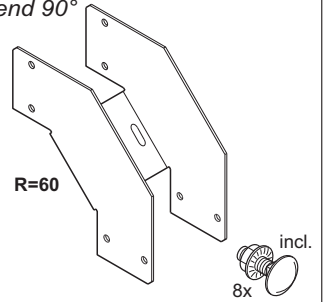

Vervalstuk 45° Vertical outer bend 45°			
B	Artikel nr. Product no.		Gewicht Weight
	AISI 304	AISI 316	
75	33502.154	33502.156	0,29
100	33503.154	33503.156	0,30
150	33504.154	33504.156	0,32
200	33505.154	33505.156	0,34
250	33506.154	33506.156	0,35
300	33507.154	33507.156	0,37

Vervalstukdeksel 45° Vertical outer bend cover 45°			
B	Artikel nr. Product no.		Gewicht Weight
	AISI 304	AISI 316	
75	35602.144	35602.146	0,08
100	35603.144	35603.146	0,11
150	35604.144	35604.146	0,16
200	35605.144	35605.146	0,22
250	35606.144	35606.146	0,27
300	35607.144	35607.146	0,33

levering inclusief:  
8 slotbouten M6 x 12  
en flensmoeren

supplied complete with:  
8 lock screws M6 x 12  
and flange nuts

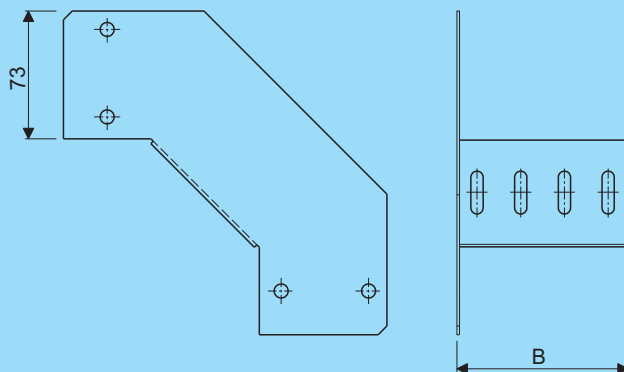

Vervalstuk 90° Vertical outer bend 90°			
B	Artikel nr. Product no.		Gewicht Weight
	AISI 304	AISI 316	
75	33522.154	33522.156	0,38
100	33523.154	33523.156	0,40
150	33524.154	33524.156	0,43
200	33525.154	33525.156	0,46
250	33526.154	33526.156	0,49
300	33527.154	33527.156	0,52

Vervalstukdeksel 90° Vertical outer bend cover 90°			
B	Artikel nr. Product no.		Gewicht Weight
	AISI 304	AISI 316	
75	35622.144	35622.146	0,15
100	35623.144	35623.146	0,19
150	35624.144	35624.146	0,29
200	35625.144	35625.146	0,39
250	35626.144	35626.146	0,48
300	35627.144	35627.146	0,58

levering inclusief:  
8 slotbouten M6 x 12  
en flensmoeren

supplied complete with:  
8 lock screws M6 x 12  
and flange nuts

# Tray H103R

Kabelkanaal H103R  
Cable duct H103R

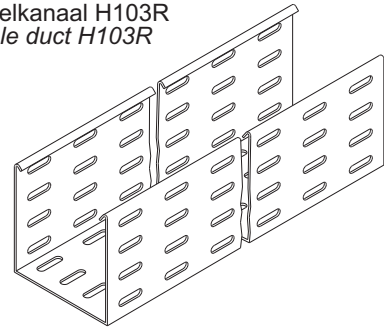

Tray

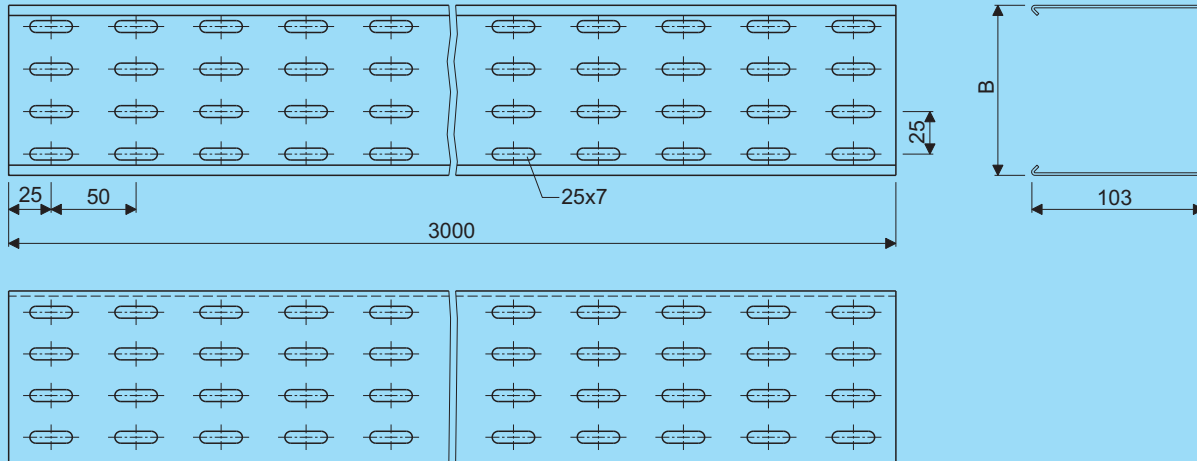

Kabelkanaal H103R Cable duct H103R			
B	Artikel nr. Product no.		Gewicht Weight
	AISI 304	AISI 316	
100	34083.154	34083.156	6,24
150	34084.154	34084.156	7,22
200	34085.154	34085.156	8,20
250	34086.154	34086.156	9,19
300	34087.154	34087.156	10,18

Kabelkanaaldeksel Cable duct cover			
	Artikel nr. Product no.		Gewicht Weight
	AISI 304	AISI 316	
	35043.144	35043.146	2,90
	35044.144	35044.146	4,10
	35045.144	35045.146	5,30
	35046.144	35046.146	6,50
	35047.144	35047.146	7,70

sleufperforatie in de lengterichting in verband met **EMC**  
*perforation slots lengthways in view of EMC*

bestel de benodigde koppelplaten apart, zij worden niet geleverd bij de kanalen  
*order splice plates as separate items, they are not supplied with the cable ducts*



Dekselveer  
Cover spring

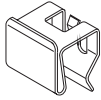

Dekselklem  
Cover clamp

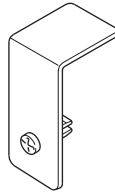

Sluitband met tape  
Fastener with tape

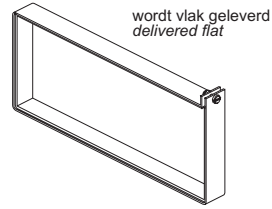

min. 1 st. per meter  
min. 1 pc. per meter



Sluitband zonder tape  
Fastener without tape

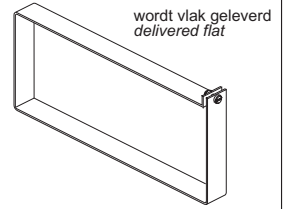

min. 1 st. per meter  
min. 1 pc. per meter

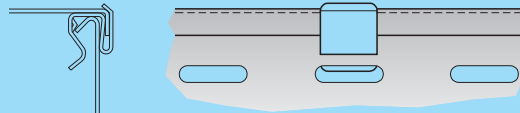
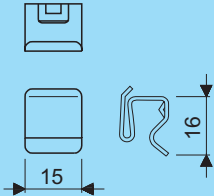

montage-toepassing  
mounting application

Dekselveer Cover spring	
Artikel nr. Product no.	Gewicht Weight
99983.209	0,002

bestel de benodigde deksel-  
veren apart, zij worden niet  
geleverd bij de deksels  
*kindly order cover springs as  
a separate item, they are  
not supplied with the covers*

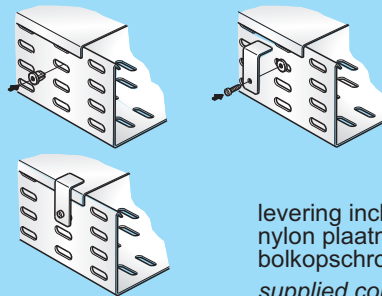
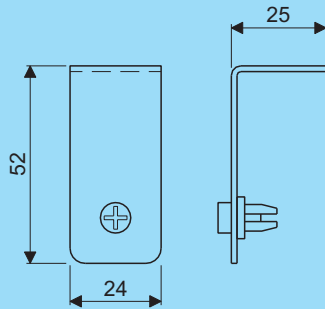

montage-toepassing  
mounting application

Dekselklem Cover clamp		
Artikel nr. Product no.		Gewicht Weight
AISI 304	AISI 316	0,02
99984.204	99984.206	

levering inclusief  
nylon plaatmoer en  
bolkopschroef  
*supplied complete  
with plate nut and  
roundhead screw*

bestel de benodigde deksel-  
klemmen apart, zij worden  
niet geleverd bij de deksels  
*kindly order cover clamps as  
a separate item, they are  
not supplied with the covers*

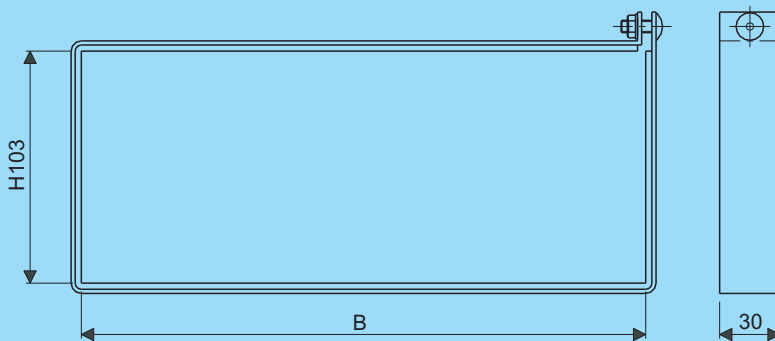

Sluitband met tape Fastener with tape			
B	Artikel nr. Product no.		Gewicht Weight
	AISI 304	AISI 316	
100	34603.154	34603.156	0,11
150	34604.154	34604.156	0,14
200	34605.154	34605.156	0,16
250	34606.154	34606.156	0,19
300	34607.154	34607.156	0,21

levering inclusief: *supplied complete with:*  
1 slotbout M6 x 12 en flensmoer *1 lock screw M6 x 12  
and flange nut*

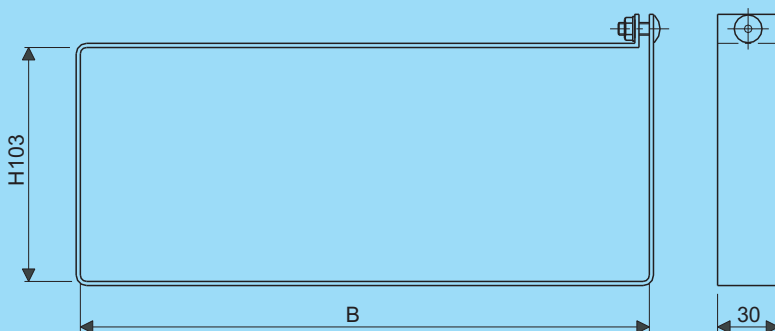

Sluitband zonder tape Fastener without tape			
B	Artikel nr. Product no.		Gewicht Weight
	AISI 304	AISI 316	
100	34613.154	34613.156	0,11
150	34614.154	34614.156	0,14
200	34615.154	34615.156	0,16
250	34616.154	34616.156	0,19
300	34617.154	34617.156	0,21

levering inclusief: *supplied complete with:*  
1 slotbout M6 x 12 en flensmoer *1 lock screw M6 x 12  
and flange nut*

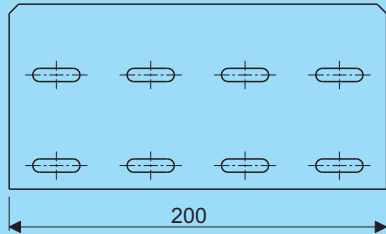
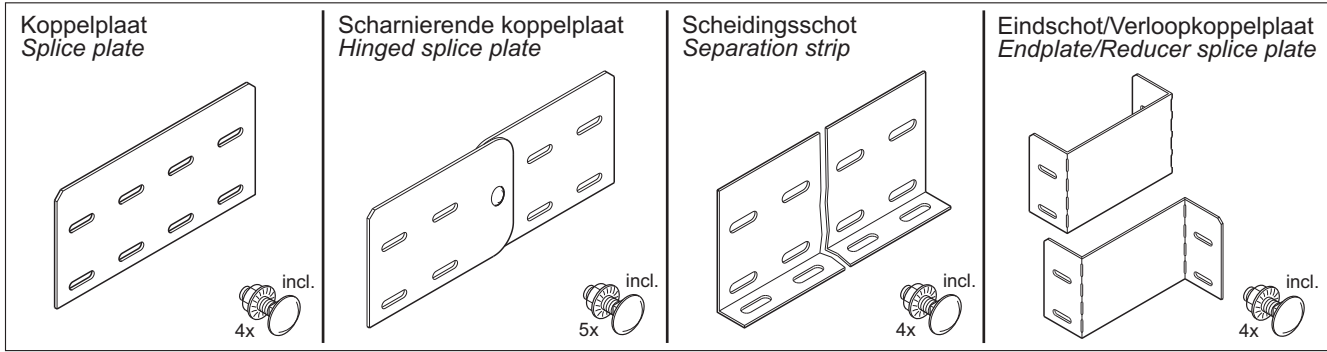

levering inclusief:  
4 slotbouten M6 x12  
en flensmoeren  
*supplied complete with:  
4 lock screws M6 x 12  
and flange nuts*

Koppelplaat Splice plate		
Artikel nr. Product no.		Gewicht Weight
AISI 304	AISI 316	
34132.154	33132.156	

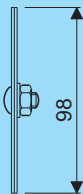
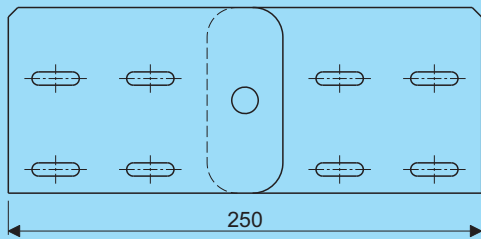

Scharnierende koppelplaat Hinged splice plate		
Artikel nr. Product no.		Gewicht Weight
AISI 304	AISI 316	
34151.154	33151.156	

levering inclusief:  
5 slotbouten M6 x12  
en flensmoeren  
*supplied complete with:  
5 lock screws M6 x 12  
and flange nuts*

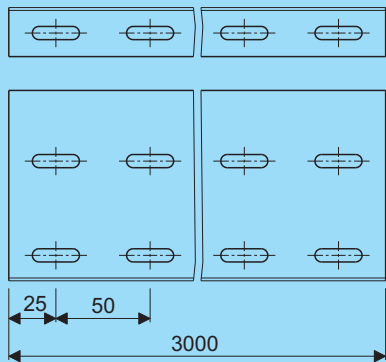

levering inclusief:  
4 slotbouten M6 x12  
en flensmoeren  
*supplied complete with:  
4 lock screws M6 x 12  
and flange nuts*

Scheidingsschot Separation strip		
Artikel nr. Product no.		Gewicht Weight
AISI 304	AISI 316	
98727.154	98727.156	

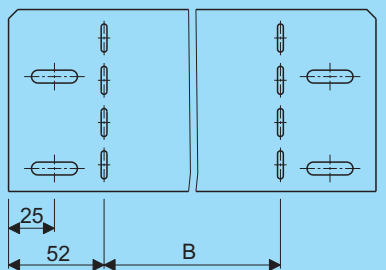

Eindschot/Verloopkoppelplaat Endplate/Reducer splice plate			
B	Artikel nr. Product no.		Gewicht Weight
	AISI 304	AISI 316	
50	34171.154	34171.156	0,14
100	34173.154	34173.156	0,18
150	34174.154	34174.156	0,22
200	34175.154	34175.156	0,26
250	34176.154	34176.156	0,29
300	34177.154	34177.156	0,33

levering inclusief:  
4 slotbouten M6 x12  
en flensmoeren  
*supplied complete with:  
4 lock screws M6 x 12  
and flange nuts*

# Tray H103

Verloopstuk  
Reducer

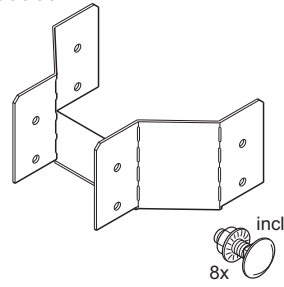

Aanzethoekstuk  
Universal corner piece

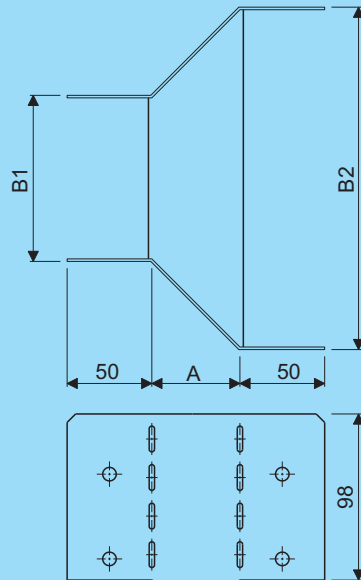
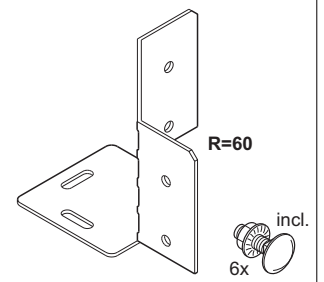

levering inclusief:  
8 slotbouten M6 x12  
en flensmoeren

supplied complete with:  
8 lock screws M6 x 12  
and flange nuts

Verloopstuk Reducer					Verloopstukdeksel Reducer cover		
A	B1-B2	Artikel nr. Product no.		Gewicht Weight	Artikel nr. Product no.		Gewicht Weight
		AISI 304	AISI 316		AISI 304	AISI 316	
44	100-150	34197.154	34197.156	0,34	35197.144	35197.146	0,08
50	100-200	34198.154	34198.156	0,39	35198.144	35198.146	0,11
75	100-250	34199.154	34199.156	0,49	35199.144	35199.146	0,16
44	150-200	34200.154	34200.156	0,36	35200.144	35200.146	0,11
50	150-250	34201.154	34201.156	0,41	35201.144	35201.146	0,14
75	150-300	34202.154	34202.156	0,52	35202.144	35202.146	0,20
44	200-250	34203.154	34203.156	0,38	35203.144	35203.146	0,14
50	200-300	34204.154	34204.156	0,43	35204.144	35204.146	0,17
44	250-300	34206.154	34206.156	0,40	35206.144	35206.146	0,17

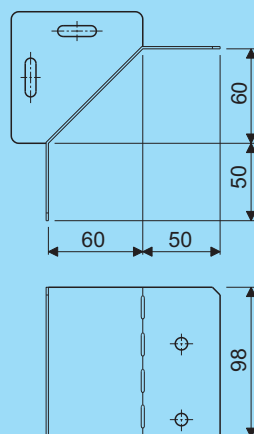

Aanzethoekstuk Universal corner piece		
Artikel nr. Product no.		Gewicht Weight
AISI 304	AISI 316	
34221.154	34221.156	0,23

levering inclusief:  
6 slotbouten M6 x12  
en flensmoeren

supplied complete with:  
6 lock screws M6 x 12  
and flange nuts

# Tray H103

Hoekstuk 45°  
Corner piece 45°

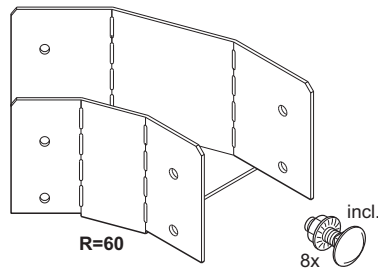

Hoekstuk 90°  
Corner piece 90°

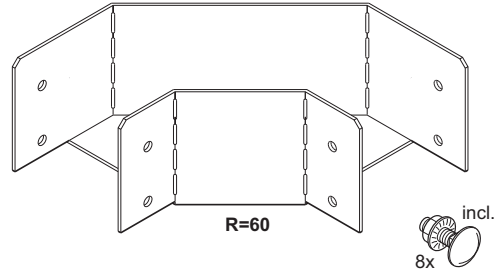

Tray

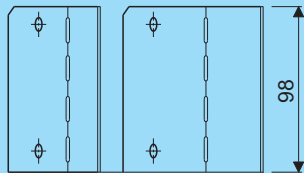
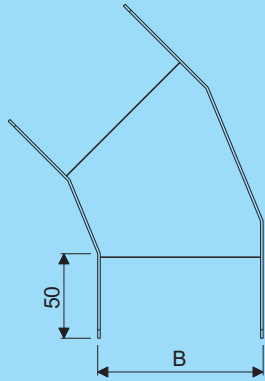

Hoekstuk 45° Corner piece 45°			
B	Artikel nr. Product no.		Gewicht Weight
	AISI 304	AISI 316	
100	34243.154	34243.156	0,41
150	34244.154	34244.156	0,50
200	34245.154	34245.156	0,60
250	34246.154	34246.156	0,72
300	34247.154	34247.156	0,86

Hoekstukdeksel 45° Corner piece cover 45°			
B	Artikel nr. Product no.		Gewicht Weight
	AISI 304	AISI 316	
100	35243.144	35243.146	0,10
150	35244.144	35244.146	0,17
200	35245.144	35245.146	0,26
250	35246.144	35246.146	0,36
300	35247.144	35247.146	0,48

levering inclusief:  
8 slotbouten M6 x 12  
en flensmoeren

supplied complete with:  
8 lock screws M6 x 12  
and flange nuts

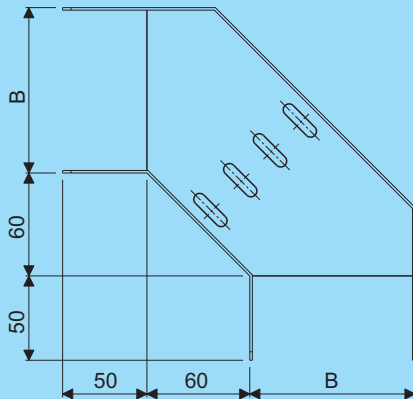

Hoekstuk 90° Corner piece 90°			
B	Artikel nr. Product no.		Gewicht Weight
	AISI 304	AISI 316	
100	34263.154	34263.156	0,59
150	34264.154	34264.156	0,76
200	34265.154	34265.156	0,97
250	34266.154	34266.156	1,22
300	34267.154	34267.156	1,49

Hoekstukdeksel 90° Corner piece cover 90°			
B	Artikel nr. Product no.		Gewicht Weight
	AISI 304	AISI 316	
100	35263.144	35263.146	0,18
150	35264.144	35264.146	0,32
200	35265.144	35265.146	0,50
250	35266.144	35266.146	0,67
300	35267.144	35267.146	0,87

levering inclusief:  
8 slotbouten M6 x 12  
en flensmoeren  
supplied complete with:  
8 lock screws M6 x 12  
and flange nuts

# Tray H103

Aftakstuk  
Branch

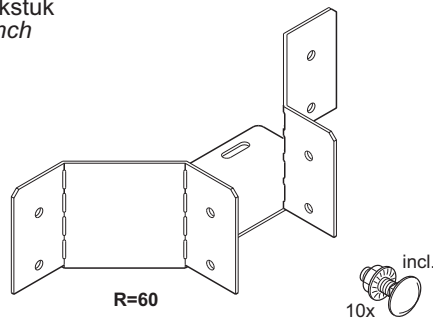

Driewegstuk (gelijkzijdig)  
Equal tee piece

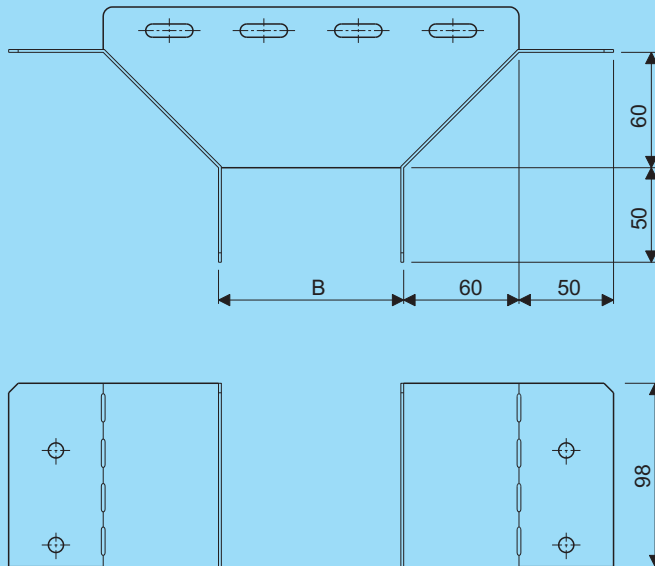
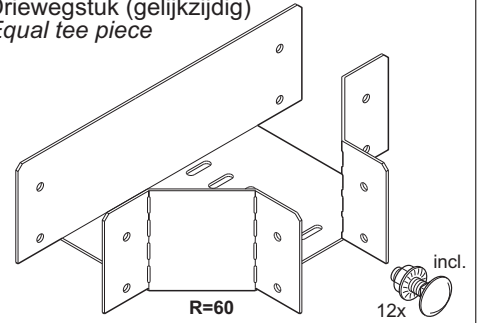

B	Artikel nr. Product no.		Gewicht Weight
	AISI 304	AISI 316	
100	34283.154	34283.156	0,50
150	34284.154	34284.156	0,64
200	34285.154	34285.156	0,83
250	34286.154	34286.156	1,05
300	34287.154	34287.156	1,31

Aftakstukdekseel  
Branch cover

B	Artikel nr. Product no.		Gewicht Weight
	AISI 304	AISI 316	
100	35283.144	35283.146	0,12
150	35284.144	35284.146	0,18
200	35285.144	35285.146	0,19
250	35286.144	35286.146	0,24
300	35287.144	35287.146	0,27

levering inclusief:  
10 slotbouten M6 x 12  
en flensmoeren

supplied complete with:  
10 lock screws M6 x 12  
and flange nuts

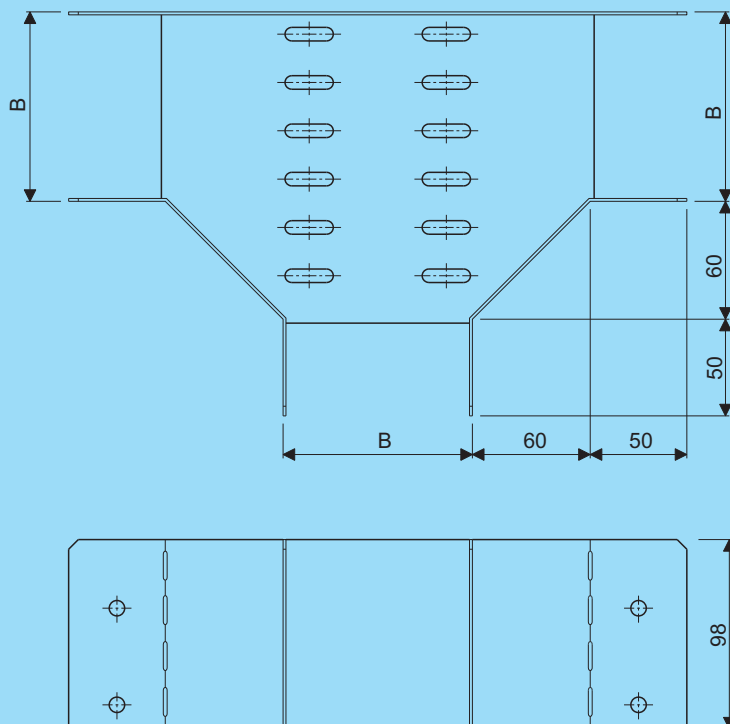

B	Artikel nr. Product no.		Gewicht Weight
	AISI 304	AISI 316	
100	34303.154	34303.156	0,85
150	34304.154	34304.156	1,06
200	34305.154	34305.156	1,30
250	34306.154	34306.156	1,59
300	34307.154	34307.156	1,91

Driewegstukdekseel (gelijkzijdig)  
Equal tee piece cover

B	Artikel nr. Product no.		Gewicht Weight
	AISI 304	AISI 316	
100	35303.144	35303.146	0,31
150	35304.144	35304.146	0,50
200	35305.144	35305.146	0,74
250	35306.144	35306.146	1,02
300	35307.144	35307.146	1,33

levering inclusief:  
12 slotbouten M6 x 12  
en flensmoeren

supplied complete with:  
12 lock screws M6 x 12  
and flange nuts

# Tray H103

Driewegstuk (ongelijkzijdig)  
Unequal tee piece (reducing)

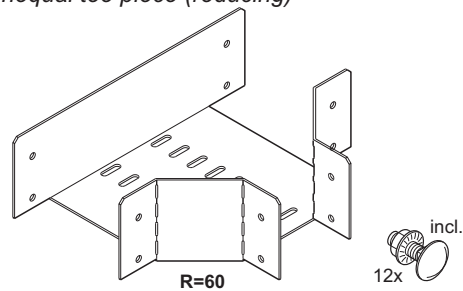

Tray

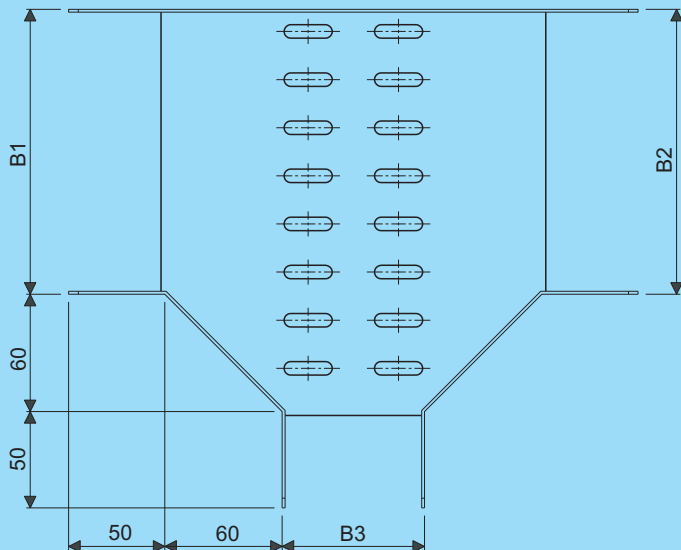

levering inclusief:  
12 slotbouten M6 x 12  
en flensmoeren  
supplied complete with:  
12 lock screws M6 x 12  
and flange nuts

Driewegstuk (ongelijkzijdig) Unequal tee piece (reducing)				Driewegstukdeksel Unequal tee piece cover		
B1-B2-B3	Artikel nr. Product no.		Gewicht Weight	Artikel nr. Product no.		Gewicht Weight
	AISI 304	AISI 316		AISI 304	AISI 316	
150-150-100	34326.154	34326.156	0,93	35326.144	35326.146	0,20
200-200-100	34329.154	34329.156	1,02	35329.144	35329.146	0,24
200-200-150	34330.154	34330.156	1,16	35330.144	35330.146	0,27
250-250-100	34333.154	34333.156	1,10	35333.144	35333.146	0,32
250-250-150	34334.154	34334.156	1,26	35334.144	35334.146	0,37
250-250-200	34335.154	34335.156	1,42	35335.144	35335.146	0,42
300-300-100	34338.154	34338.156	1,18	35338.144	35338.146	0,40
300-300-150	34339.154	34339.156	1,36	35339.144	35339.146	0,46
300-300-200	34340.154	34340.156	1,54	35340.144	35340.146	0,52
300-300-250	34341.154	34341.156	1,73	35341.144	35341.146	0,63

# Tray H103

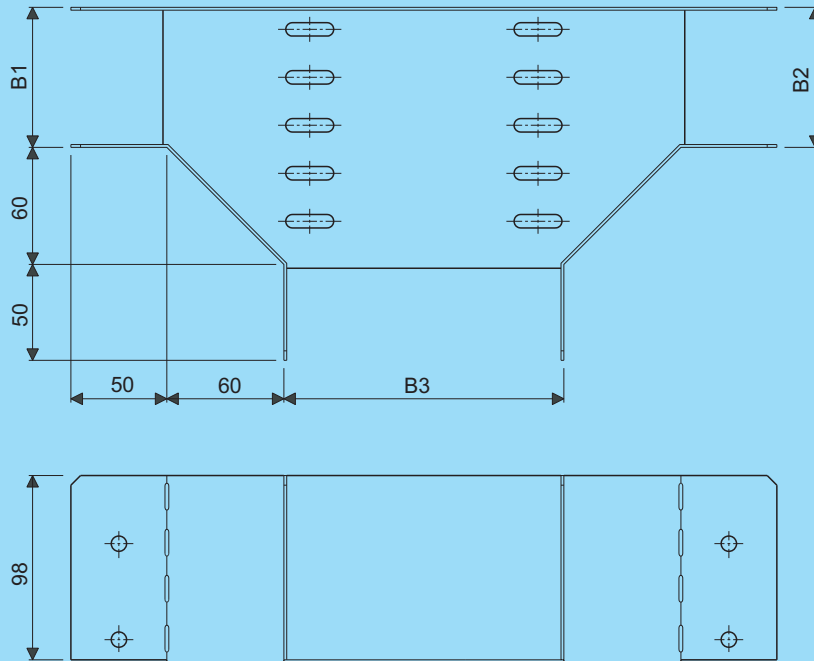
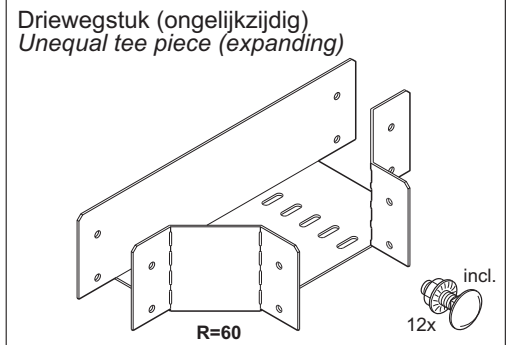

Tray

levering inclusief:  
12 slotbouten M6 x 12  
en flensmoeren  
supplied complete with:  
12 lock screws M6 x 12  
and flange nuts

Driewegstuk (ongelijkzijdig) Unequal tee piece (expanding)				Driewegstukdeksel Unequal tee piece cover		
B1-B2-B3	Artikel nr. Product no.		Gewicht Weight	Artikel nr. Product no.		Gewicht Weight
	AISI 304	AISI 316		AISI 304	AISI 316	
100-100-150	34372.154	34372.156	0,96	35372.144	35372.146	0,19
100-100-200	34373.154	34373.156	1,06	35373.144	35373.146	0,22
100-100-250	34374.154	34374.156	1,16	35374.144	35374.146	0,27
100-100-300	34375.154	34375.156	1,27	35375.144	35375.146	0,32
150-150-200	34376.154	34376.156	1,18	35376.144	35376.146	0,38
150-150-250	34377.154	34377.156	1,30	35377.144	35377.146	0,43
150-150-300	34378.154	34378.156	1,43	35378.144	35378.146	0,27
200-200-250	34379.154	34379.156	1,45	35379.144	35379.146	0,33
200-200-300	34380.154	34380.156	1,59	35380.144	35380.146	0,39
250-250-300	34381.154	34381.156	1,75	35381.144	35381.146	0,46

# Tray H103

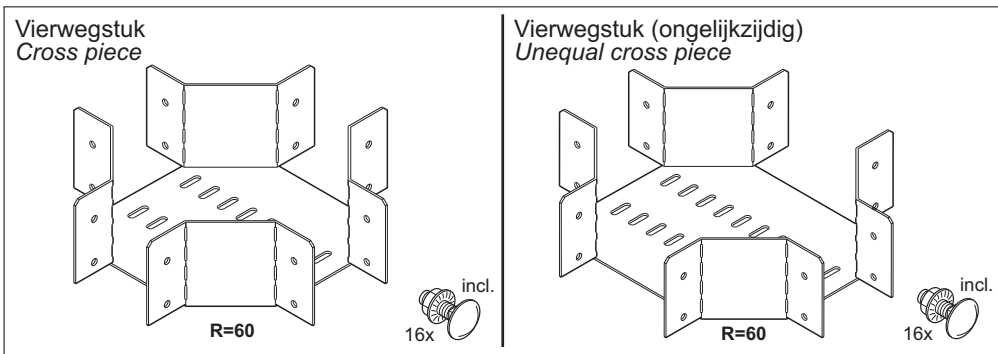

Tray

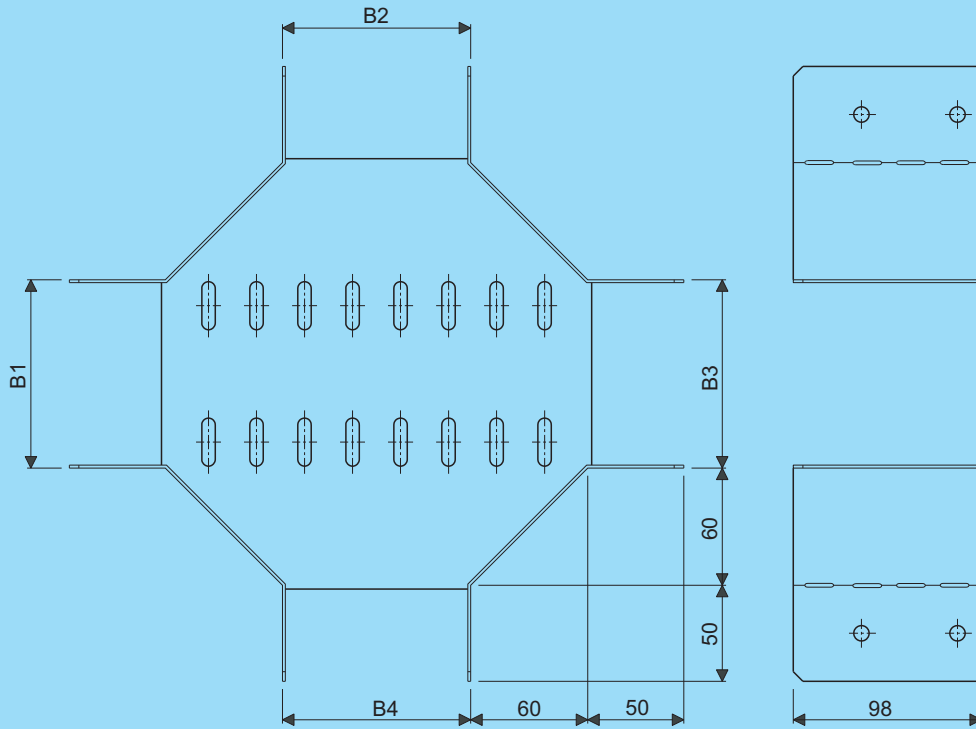

Vierwegstuk Cross piece			Vierwegstukdeksel Cross piece cover			
B1-B2-B3-B4	Artikel nr. Product no.		Gewicht Weight	Artikel nr. Product no.		Gewicht Weight
	AISI 304	AISI 316		AISI 304	AISI 316	
100-100-100-100	34403.154	34403.156	1,00	35403.144	35403.146	0,22
150-150-150-150	34404.154	34404.156	1,18	35404.144	35404.146	0,29
200-200-200-200	34405.154	34405.156	1,41	35405.144	35405.146	0,40
250-250-250-250	34406.154	34406.156	1,68	35406.144	35406.146	0,58
300-300-300-300	34407.154	34407.156	1,99	35407.144	35407.146	0,88
150-100-150-100	34426.154	34426.156	1,08	35426.144	35426.146	1,18
200-100-200-100	34429.154	34429.156	1,16	35429.144	35429.146	1,52
200-150-200-150	34430.154	34430.156	1,28	35430.144	35430.146	0,26
250-100-250-100	34433.154	34433.156	1,24	35433.144	35433.146	0,30
250-150-250-150	34434.154	34434.156	1,38	35434.144	35434.146	0,35
250-200-250-200	34435.154	34435.156	1,53	35435.144	35435.146	0,38
300-100-300-100	34438.154	34438.156	1,32	35438.144	35438.146	0,44
300-150-300-150	34439.154	34439.156	1,49	35439.144	35439.146	0,50
300-200-300-200	34440.154	34440.156	1,65	35440.144	35440.146	0,46
300-250-300-250	34441.154	34441.156	1,82	35441.144	35441.146	0,53

levering inclusief:  
16 slotbouten M6 x 12  
en flensmoeren  
supplied complete with:  
16 lock screws M6 x 12  
and flange nuts



# Tray

## H103

Stijgstuk 45°  
Vertical inner bend 45°

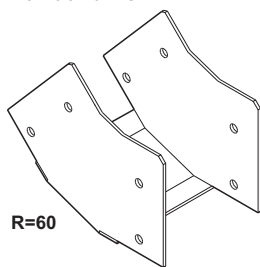

R=60



Stijgstuk 90°  
Vertical inner bend 90°

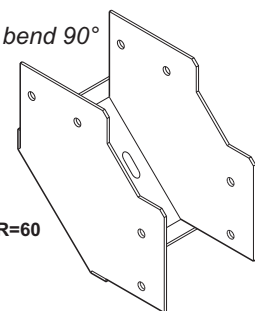

R=60

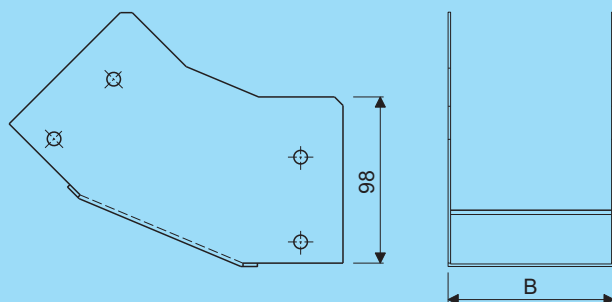

Stijgstuk 45° Vertical inner bend 45°			
B	Artikel nr. Product no.		Gewicht Weight
	AISI 304	AISI 316	
100	34463.154	34463.156	0,44
150	34464.154	34464.156	0,49
200	34465.154	34465.156	0,54
250	34466.154	34466.156	0,59
300	34467.154	34467.156	0,64

Stijgstukdeksel 45° Vertical inner bend cover 45°			
B	Artikel nr. Product no.		Gewicht Weight
	AISI 304	AISI 316	
100	35463.144	35463.146	0,07
150	35464.144	35464.146	0,10
200	35465.144	35465.146	0,13
250	35466.144	35466.146	0,15
300	35467.144	35467.146	0,19

levering inclusief:  
8 slotbouten M6 x 12  
en flensmoeren

supplied complete with:  
8 lock screws M6 x 12  
and flange nuts

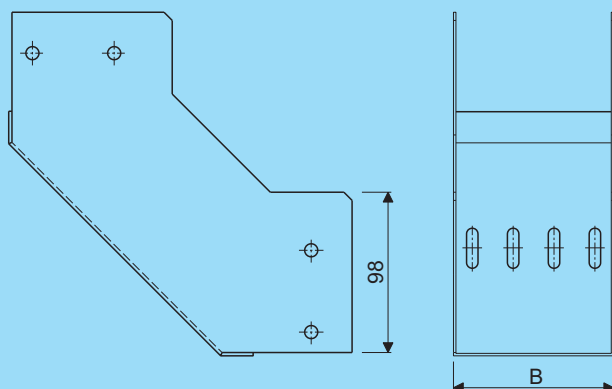

Stijgstuk 90° Vertical inner bend 90°			
B	Artikel nr. Product no.		Gewicht Weight
	AISI 304	AISI 316	
100	34483.154	34483.156	0,65
150	34484.154	34484.156	0,75
200	34485.154	34485.156	0,85
250	34486.154	34486.156	0,94
300	34487.154	34487.156	1,04

Stijgstukdeksel 90° Vertical inner bend cover 90°			
B	Artikel nr. Product no.		Gewicht Weight
	AISI 304	AISI 316	
100	35483.144	35483.146	0,10
150	35484.144	35484.146	0,15
200	35485.144	35485.146	0,20
250	35486.144	35486.146	0,23
300	35487.144	35487.146	0,29

levering inclusief:  
8 slotbouten M6 x 12  
en flensmoeren

supplied complete with:  
8 lock screws M6 x 12  
and flange nuts

# Tray H103

Vervalstuk 45°  
Vertical outer bend 45°

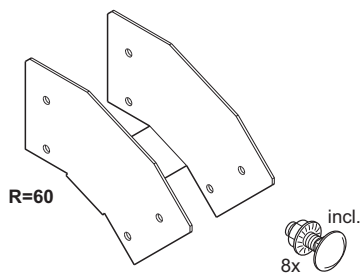

Vervalstuk 90°  
Vertical outer bend 90°

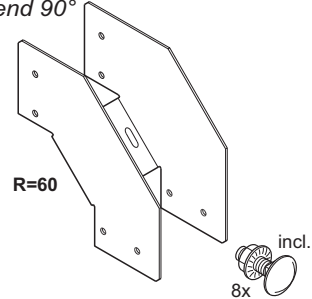

Tray

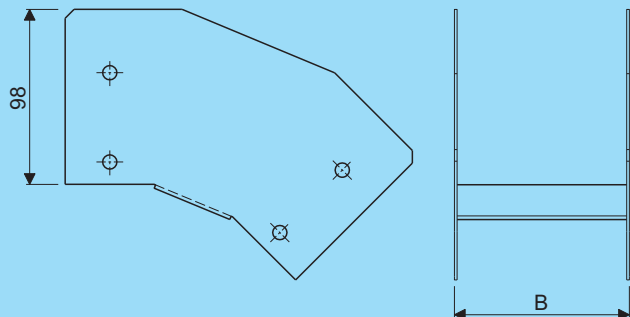

Vervalstuk 45° Vertical outer bend 45°			
B	Artikel nr. Product no.		Gewicht Weight
	AISI 304	AISI 316	
100	34503.154	34503.156	0,39
150	34504.154	34504.156	0,40
200	34505.154	34505.156	0,42
250	34506.154	34506.156	0,44
300	34507.154	34507.156	0,46

Vervalstukdeksel 45° Vertical outer bend cover 45°			
B	Artikel nr. Product no.		Gewicht Weight
	AISI 304	AISI 316	
100	35643.144	35643.146	0,12
150	35644.144	35644.146	0,18
200	35645.144	35645.146	0,25
250	35646.144	35646.146	0,31
300	35647.144	35647.146	0,37

levering inclusief:  
8 slotbouten M6 x 12  
en flensmoeren

supplied complete with:  
8 lock screws M6 x 12  
and flange nuts

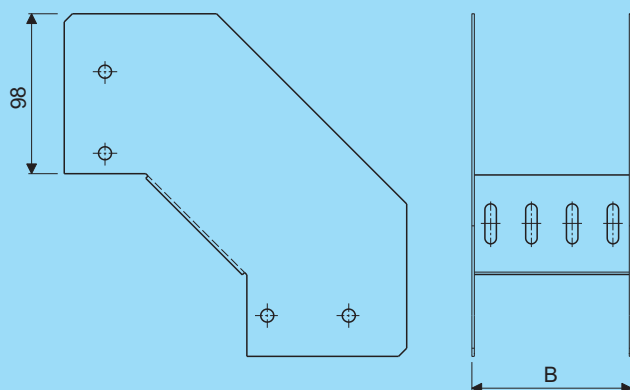

Vervalstuk 90° Vertical outer bend 90°			
B	Artikel nr. Product no.		Gewicht Weight
	AISI 304	AISI 316	
100	34523.154	34523.156	0,53
150	34524.154	34524.156	0,56
200	34525.154	34525.156	0,59
250	34526.154	34526.156	0,62
300	34527.154	34527.156	0,65

Vervalstukdeksel 90° Vertical outer bend cover 90°			
B	Artikel nr. Product no.		Gewicht Weight
	AISI 304	AISI 316	
100	35663.144	35663.146	0,22
150	35664.144	35664.146	0,33
200	35665.144	35665.146	0,45
250	35666.144	35666.146	0,56
300	35667.144	35667.146	0,67

levering inclusief:  
8 slotbouten M6 x 12  
en flensmoeren

supplied complete with:  
8 lock screws M6 x 12  
and flange nuts